

EUROPEAN RESEARCH ON
CETACEANS - 8

**PROCEEDINGS OF THE EIGHTH ANNUAL CONFERENCE
OF THE EUROPEAN CETACEAN SOCIETY,
MONTPELLIER, FRANCE
2-5 MARCH 1994**



EDITOR : P.G.H. EVANS

EUROPEAN RESEARCH ON CETACEANS - 8

Proceedings of the Eighth Annual Conference
of the European Cetacean Society,
Montpellier, France
2-5 March 1994

Editor : P.G.H. Evans

Date of Publication: December 1994

Place of Publication: Lugano, Switzerland

CONTENTS

Introduction	6
Cockcroft, V. Are protected areas a viable means of conserving dolphins?	7
Carlson, C. A. and Papastavavrou, V. Review of whale sanctuaries around the world: a progress report	10
Heide-Jørgensen, M. P. and Dietz, R. The use of a wildlife sanctuary in northwest Greenland by narwhals	11
Berrow, S. D. and Rogan, E. Ireland - a sanctuary for whales and dolphins: the implications of Irelands' sanctuary declaration	12
Creton, P., Allali, P., Guinet, C. and Ridoux, V. Zonation and regulations for a marine mammal national park proposed from field studies of habitat use by resident marine mammals: the example of the project <i>Parc National Marin de L'Iroise</i> , Brittany, France	14
Notarbartolo di Sciara, G. The Mediterranean sanctuary for the protection of cetaceans: a difficult transition from paper to reality	18
Birkun, Alexei Jr. and Stetsenko, Nikolai The Ukrainian national programme for the conservation of Black Sea dolphin populations	22
Hoyt, Erich Whale-watching worldwide: an overview of the industry and the implications for science and conservation	24
Sears, R. Whale-watching and its impact on marine mammal research	30
Gordon, J. C. D. Collecting scientific data on whale-watching projects: opportunities and problems	32
Schmidt, R. C. and Hussel, B. Tourists and locals; seals and porpoises - friendly interaction and mutual endangering, examples from the German island Sylt, North Sea	36
Heimlich-Boran, J.R., Heimlich-Boran, S.L., Montero, R. and Martin, V. An overview of whale-watching in the Canary Islands	37
Donovan, G. P. and Hammond, P. S. The IWC'sRMP and RWS - acronyms, anachronisms or a management procedure for white elephants?	40
Brownell, Jr., R. L. Large-scale driftnet fishing: where are we after the United Nations moratorium	41
Hall, M. A. Ecological impacts of fishing operations: assessment and mitigation in the eastern Pacific tuna-dolphin interaction	42
Goujon, M., Antoine, L., Collet, A., and Fifas, S. A study of the ecological impact of the French tuna driftnet fishery in the North-east Atlantic	47
Moreno, P. Interactions of the German fisheries with small cetaceans in the North Sea: a first approach	49
Schmidt, R. C. and Hussel, B. By-catches - fleeting netmarks on small cetaceans	53
Goodson, D. A. Bottom set gill-nets: problems of perception for dolphins and porpoises	54
Artov, A., Pavlov, V. and Zhuravleva, T. Incidental killing of Black Sea dolphins off the Crimea and Krasnodar territory coasts: analysis of official data and outlook	58
Evans, P. G. H., Carson, Q., Fisher, P., Jordan, W., Limer, R. and Rees, I. A study of the reactions of harbour porpoises to various boats in the coastal waters of Southeast Shetland	60

André, M., Ramos, A. G. and López Jurado, L. F. Sperm whale acoustic survey off the Canary Islands, in an area of heavy maritime traffic: preliminary results	65
Fairbairns, R., Booth, J., Walmsley, T., Fairbairns, J., Menhenett, C. and Gordon, J. Molly: a minke whale in a small loch on the Scottish island of Lewis	66
Wilson, B., Thompson, P., Hammond, P., and Curran, S. The distribution of bottlenose dolphins in the Moray Firth, Northeast Scotland	67
Gordon, J. C. D., Fennelly, S., Berrow, S. and Rogan, E. A cetacean survey in the Irish Whale and dolphin sanctuary: North Mayo, summer 1993	68
Kiely, O., Berrow, S. D., and Holmes, B. Occurrence and group size of bottlenose dolphins (<i>Tursiops truncatus</i>) off Kilcredaun head, County Clare, Ireland	69
Tregenza, N. J. C. 'Temporary residence' of bottlenose dolphin (<i>Tursiops truncatus</i>)	73
Tregenza, N. J. C. and Stipala, K. Have you ever heard of the porpoise? A UK survey of public understanding	74
Pierpoint, C., Earl, S. and Baines, M. Observations of harbour porpoise in West Wales, 1993	75
Goujon, M., Forcada, J. and Desportes, G. Fin whale abundance in the eastern North Atlantic, estimated from the French program Mica-93 data	81
Cañadas, A. and Sagarminaga, R. Analysis of the role of volunteers in a field study on the distribution and dynamics of cetaceans along the south-eastern coast of Spain	84
Castells, A. and Mayo, M. False killer whale (<i>Pseudorca crassidens</i> , Owen 1846) in Mallorca, Balearic Islands (Spain)	86
Gannier, A., Beaubrun, P. and Di-Méglio, N. Cetacean occurrence in the Gulf of Lion and surroundings	87
Bompar, J. M., Baril, D., Dhermain, F. and Ripoll, T. Estimation of the Corsican population of bottlenose dolphins (<i>Tursiops truncatus</i>): is there a real conflict with fishermen?	92
Forcada, J. Striped dolphin habitats in the Northwestern Mediterranean	95
Forcada, J., Aguilar, A., Hammond, P. S., Pastor, X. and Aguilar, R. Striped dolphin abundance in the Northwestern Mediterranean	96
Gannier, A. and Gannier, O. Abundance of <i>Grampus griseus</i> in Northwestern Mediterranean	99
Franco, I. and Mas, J. Distribution and evaluation of cetaceans in the Alboran Sea (S.E. Mediterranean)	103
Boutiba, Z. Cetaceans in Algerian coastal waters	104
Chakroun, F. Status of cetaceans in Tunisian marine waters	107
Carpentieri, P., Marini, L. and Consiglio, C. A cetacean survey in the Aegean Sea: work in progress	108
Politi, E., Airoidi, S. and Notarbartolo di Sciara, G. A preliminary study of the ecology of cetaceans in the waters adjacent to Greek Ionian Islands	111
Pulcini, M. and Angradi, A. M. Observations of Cuvier's beaked whale <i>Ziphius cavirostris</i> (Cetacea, Odontoceti) in the Ionian Islands of Greece	116
Holcer, D. Prospective of cetology in Croatia	120
Artov, A. A. The harbour porpoise (<i>Phocoena phocoena relicta</i>) in waters off Crimea	122

Silva, A. G., dos Santos, M. E., Harzen, S. and Viallelle, S. Cetacean sightings from a vantage point on the Azorean island of Pico during the summer of 1993	124
Aguilar, A., Calzada, N., Grau, E. and Lockyer, C. Striped dolphins from the Mediterranean and the Sea of Japan: two sides of the same coin?	127
Calzada, N. and Aguilar, A. Geographical variation in body size in western Mediterranean striped dolphins <i>Stenella coeruleoalba</i>	128
Valentini, T., Marini, L. and Consiglio, C. Analysis of the variability in the pigmentation of striped dolphin <i>Stenella coeruleoalba</i> (Meyen,1833), in the central Tyrrhenian Sea	132
Lockyer, C. H. Teeth of marine mammals: tools for age determination and much more	136
Desportes, G. Preliminary comparison between average age at first ovulation and at first lactation in long-finned pilot whales off the Faroe Islands	137
Desportes, G., Saboureau, M. and Lacroix, A. Seasonality and social maturity in male long-finned pilot whales (<i>Globicephala melas</i>) off the Faroe Islands	141
Desportes, G. Andersen, L. W. and Bloch, D. Variation in foetal and postnatal sex ratios in long-finned pilot whales	142
Di-Méglio, N. and Collet, A. Reproductive parameters in striped dolphins from the Mediterranean and Atlantic coast of France	145
Kaarstad, S. E., Bjørge, A., Lindstedt, I. and Balbuena, J. A. Growth patterns of the harbour porpoise (<i>Phocoena phocoena</i>) in Norwegian and Swedish waters	148
Jaquet, N. and Whitehead, H. Spatial organisation and distribution of sperm whales <i>Physeter macrocephalus</i> in the South Pacific	152
Herzing, D. L. The contextual nature of underwater behaviour and vocalizations in Atlantic spotted dolphins <i>Stenella frontalis</i>	156
Brunnick, B. J. Vocal pattern of two captive male bottlenose dolphins <i>Tursiops truncatus</i>	159
Mahadevan, S., Datta, S. and Goodson, A. D. Feature extraction analysis of dolphin whistles	160
Sturtivant, C., Datta, R. and Goodson, S. A. A review of echolocation research on the harbour porpoise (<i>Phocoena phocoena</i>) and the common dolphin (<i>Delphinus delphis</i>)	164
Chappell, O. and Gordon, J. Harbour porpoise acoustic surveying methods: development of equipment for automatic recognition and computerised logging of vocalisations	169
Evans, P. G. H. and Chappell, O. A comparison of visual and acoustic techniques for surveying harbour porpoises	172
Gordon, J. C. D. A simple photogrammetric method for measuring ranges to cetaceans at sea	176
Relini, L. O., Relini, G., Cima, C., Palandri, G. Relini, M. and Torchia, G. <i>Meganyctiphanes norvegica</i> and fin whales in the Ligurian Sea: new seasonal patterns	179
Azzali, M., Casini, L. and Lamberti, C.V. Relationships between dolphins, type of prey aggregation, and their geographic distribution	183
Liret, C., Allali, P., Creton, P., Guinet, C. and Ridoux, V. Foraging activity pattern of bottlenose dolphins around Ile de Sein, France, and its relationships with environmental parameters	188
Relini, O. L., Cappello, M. and Poggi, R. The stomach content of some bottlenose dolphins (<i>Tursiops truncatus</i>) from the Ligurian Sea	192

Blanco, C., Aznar, F. J. and Raga, J. A. Food habits of <i>Stenella coeruleoalba</i> in the western Mediterranean during the 1990 die-off, with special reference to squids	196
Rogan, E., Berrow, S. D. and Maloney, M. Stomach contents of small cetaceans from Irish waters	199
Jensen, J. An abnormal minke whale caught at West Greenland	200
Androukaki, E. and Tounta, E. A study of the distribution and pathology of cetaceans in Greece	203
Lipscomb, T. P. and Kennedy, S. An outbreak of morbillivirus disease in Atlantic bottlenose dolphins of the Gulf of Mexico	207
Schulman, F. Y., Lipscomb, T. P. and Kennedy, S. A reevaluation of the United States 1987-88 Atlantic coast bottlenose dolphin mortality event with evidence for a viral etiology	208
Ross, H. M., Reid, R. J., Howie, F. E. and Gray, E. W. Herpes virus infection of the general tract in harbour porpoise <i>Phocoena phocoena</i>	209
Aguilar, A. Methodological approaches to monitor organochlorine pollutants and their effects in cetaceans	210
André, J.M. The study of dolphin contamination: the need to improve the definition of objectives and methodological approaches in order to attain concrete scientific interest	211
Addink, M. J., Hartmann, M. G., Smeenk, C., Mulder, P. and Verhoeven, A. J. I. M. Aspects of biology and pollutant levels in harbour porpoises <i>Phocoena phocoena</i> stranded on the Dutch Coast, 1990-1993	213
Arnoux, A., Augier, H., Monod, J.L. and Mialon, S. Polychlorinated biphenyl concentrations in striped dolphins <i>Stenella coeruleoalba</i> beached along the Provençal French sea coast	214
Borrell, A., Corsolini, S. and Focardi, S. Evaluation of toxicity and sex-related variation of coplanar PCB levels in Mediterranean striped dolphins	222
Caurant, F. and Navarro, M. Cadmium and mercury transfer during pregnancy in the marine mammal, long-finned pilot whale (<i>Globicephala melas</i>) off the Faroe Islands	226
Augier, H., Park, W. K. and Ronneau, C. Neutron activation study of the elementary composition of the striped dolphin (<i>Stenella coeruleoalba</i> , Meyen) collected from the French Mediterranean coast	227
Gol'din, E.B. The algal investigations for water pollution determination in marine mammal capture sites	235
Birkun, A. Jr., Stanenis, A. and Tomakhin, M. Action plan for rescue, rehabilitation and reintroduction of wild sick and traumatised Black sea cetaceans	237
Krivokhizhin, S. and Birkun, A, Jr. Some changes in the helminth fauna of Black Sea dolphins	238
Balbuena, J. A., Raga, J. A., Aznar, F. J. and Fernández, M. Intestinal helminths as biological indicators of long-finned pilot whales off the Faroe Islands	240
Aznar, F. J. Balbuena, J. A. and Raga, J. A. On the identity and emigration of <i>Scolex pleuronectis</i> larvae (Cestoda) in the striped dolphin	243
Herreras, V. Fernández, M., Lockyer, C. and Raga, J.A. Finding of lungworms (Nematoda: Pseudaliidae) in a calf of harbour porpoise (<i>Phocoena phocoena</i>) in British waters	247
Soulier, L. and Collet, A. Note on crustaceans recorded on dolphins incidentally caught in the Northeastern Atlantic	248
Oliver, G. and Trilles, J.P. Cyamids (Crustacea, Amphipoda) parasites of cetaceans off French Mediterranean coasts	251

Mariniello, L., Cerioni, S. and Di Cave, D. Redescription of <i>Syncyamus aequus</i> (Amphipoda: Cyamidae), parasite of striped dolphin (<i>Stenella coeruleoalba</i>), and first record in Italian waters	255
Curry, B. E., Cockcroft, V. G. and Dizon, A. E. Genetic variation in bottlenose dolphins (<i>Tursiops truncatus</i>)	256
García-Martínez, J., Latorre, A. and Raga, J.A. Genetic variability of striped dolphin (<i>Stenella coeruleoalba</i>) in Spanish Mediterranean waters	257
Walton, M. Genetic diversity of harbour porpoise populations around the British Isles: preliminary results	261
Bortolotto, A. The microscopic structure of the lung in Cetacea: phylogenetic considerations	265
Masini, M. A., Veirana, N., Würtz, M. and Uva, B. The renin-angiotensin system in a striped dolphin (<i>Stenella coeruleoalba</i>) kidney	269
Silvani, L., Aguilar, A., Borrell, A., Desportes, G. and Gazo, J. M. Variation in adrenal gland size and morphology in pilot whales (<i>Globicephala melas</i>) from the Faroe Islands	272
Baines, M., Pierpoint, C., Strong, P. and Poole, J. The west Wales grey seal census	275
Grau, E., Aguilar, A., González, J., Félix, S. M., González, L. M. and López-Jurado, L. F. Photo-identification of Mediterranean monk seals (<i>Monachus monachus</i>) off the coast of the southern Sahara	279
González, L. M., González, J., Félix, S. M., Grau, E., López-Jurado, L. F. and Aguilar, A. Pupping season and annual production of the monk seal (<i>Monachus monachus</i>) in "Cabo Blanco" Peninsula (western Sahara-Mauritania)	281
Seventh Annual Report of the European Cetacean Society: 1993	284
Financial Report for 1993 (up to February 1994)	285
European Cetacean Society	286
Officers and Members of the Council	287
National Contact Persons	287

INTRODUCTION

The seventh annual conference of the European Cetacean Society was held in Montpellier, France between 2 and 5 March, 1994. It was attended by 238 persons from twenty countries. The Council of the ECS are very grateful to Jean-Michel Bompar and Hélène Petit and their team of assistants for organising an extremely successful conference.

The proceedings that follow are abstracts of the talks and posters presented at the conference. As always, the contributions have been edited only to improve clarity and to maintain a uniformity of presentation. No external refereeing has taken place and much of the material presented here it is hoped will eventually be formally published in greater detail in scientific journals.

I have tried to arrange the abstracts broadly by subject, and for this reason, the invited key note lectures are slotted into appropriate spots through the volume. I would like to take this opportunity to give warm thanks to the invited speakers, some of whom came a great distance to address the society: Rick Sears and Martin Hall from North America, and Erich Hoyt from England.

Finally, I should like to thank Deborah Brady for all the work she has put in to typing out these proceedings.

Peter G.H. Evans

ARE PROTECTED AREAS VIABLE FOR THE CONSERVATION OF COASTAL DOLPHINS?

V.G. Cockcroft

Centre for Dolphin Studies, Port Elizabeth Museum,
P.O. Box 13147 Humewood, 6013, South Africa

Dolphins can be crudely divided by habitat: nearshore (>50 m depth), coastal (>50<200 m) and oceanic. Within these, dolphins can be further broadly divided according to their movements and food resources: wide ranging/migratory - probably in response to food availability; less wide ranging - those making use of locally abundant resources.

Consequently, a number of factors need consideration in the establishment of Protected Areas (PAs - reserves), if they are to be effective in cetacean conservation and management. Factors which need consideration in the establishment of coastal PAs include home range; the minimum amount of genetic exchange needed between adjacent groups - the range of 'roving' males - to prevent genetic isolation; the carrying capacity required to feed a group (depends on the group size); and the necessary number of groups needed to satisfy social interaction requirements.

Yet, most existing PAs are coastal, in that they encompass a length of coastline out to a pre-determined distance offshore or depth contour. Our limited knowledge of dolphin biology and the minimum requirements for conservation indicate that most of these PAs are too small to be effective, even for coastal dolphins with a limited range.

The design of research to assess the viability of PAs before they are established is presented here, with special reference to dolphin research in South Africa over the past 15 years.

Most Protected Areas (PAs) are coastal, their boundaries defined by:

- (a) a length of coast, an island or a reef.
- (b) a particular distance from shore, surrounding the island or reef (sometimes a depth contour).

Historically, these areas were proclaimed because of the perceived value of the coastal morphology and/or of the inshore fauna and flora. What are the typical characteristics of coastal PAs.

In southern African waters, coastal PAs typically:

- (a) Consist of a stretch of coast between 30 km and 100 km long, or encompass an island.
- (b) Are five kilometres wide, from the shore or island, or out to the 30 m isobath.
- (c) Encompass coastal forest or dune fields, reefs (hard & soft coral), river mouths & estuaries.

Generally, these reserves are used for tourism, typically hiking, and sometimes diving, trails, etc. But, how valuable are these PAs for coastal, or nearshore, dolphins? To determine this, we need to know something of the natural history of the dolphins that we are trying to conserve. In southern African waters, three species of dolphin inhabit coastal waters (defined as within the continental shelf boundary - <200 m in depth) (the dugong inhabits coastal waters out to about 50 m).

The Indo-Pacific humpback dolphin - *Sousa chinensis*

The Indian Ocean bottlenose dolphin - *Tursiops truncatus*

The common dolphin - *Delphinus delphis*.

To determine whether coastal PAs are viable for any of these dolphins, we need to examine aspects of their natural history, movements, and range.

What do we know about humpback dolphins?

Humpback dolphin group sizes are small, typically less than ten. Nothing is known of group structure, but identified dolphins are often seen repeatedly (within two or three days) at localities several hundred kilometres apart. Humpback dolphins feed predominantly on estuarine and reef associated fish. So, to be viable in the conservation of humpback dolphins, PAs need to fulfill the following criteria:

- (a) Cover at least several hundred kilometres of coast. They may even need to be bigger if the genetic interchange between groups is to be maintained!
- (b) In view of the food preferences of these dolphins, PAs need to encompass at least one river mouth and reef.
- (c) The seaward boundary needs to be at least the 30 m isobath.

What do we know about bottlenose dolphins?

Bottlenose dolphins are relatively large (typically between 30 and 60 individuals), apparently matrilineal, with 'home ranges' covering about 40 km of coast and out to the 30 m isobath. Males seem to roam more widely and are sometimes seen at localities 200-300 km apart. Bottlenose dolphins feed primarily on sandy bottom and reef associated prey. So, to be viable for bottlenose dolphins, PAs need to fulfill the following criteria:

- (a) For one group, only a PA along a coastal belt of 40 to 60 km is needed. But for genetic interchange between two or more groups and to satisfy the needs of roaming males, a PA may need to be substantially larger.
- (b) The seaward boundary needs to be at least at the 30 m isobath.
- (c) In view of the food preferences of these dolphins, PAs need to encompass at least some reef area.

What do we know about common dolphins?

Common dolphins occur in groups of up to several thousand, which seasonally move over vast distances (>1,000 km). Though the structure of groups is unknown, there appears to be geographic and temporal segregation of sex and age classes, sometimes over several hundred kilometres. Common dolphins feed primarily on small, schooling prey. As a result, PAs aimed at conserving common dolphins would need to fulfil the following criteria:

- (a) In view of the seasonal migrations of common dolphins, PAs would need to cover a coastal belt of at least 1,000 km!
- (b) The seaward boundary needs to be at least at the continental shelf edge, at the 200 m isobath.
- (c) The migrations of the primary food resource, schooling prey, need to be taken into consideration.

Do existing PAs satisfy the biological needs of any of these three species? In other words, are existing southern African PAs a viable means of conserving or protecting any of these three dolphin species? In the light of what we know about each of the species, the obvious answer is NO!

How does one make sure that a proposed PA will be beneficial to the animals (cetaceans) it is designed to conserve? The answer is a well designed research programme, with key questions similar to those given below for assessing PA viability for coastal dolphins.

KEY QUESTIONS:

- (1) What is the density of dolphins inside and outside the PA?
- (2) What are the movement patterns inside and outside the PA?
 - (a) Do they range throughout the PA?
 - (b) How far outside the PA do they move?
 - (c) Does the 'home range' have any relationship to the PA?
- (3) Do they use the habitat/resources inside and outside equally?
 - (a) Do they feed/mate more inside or outside?
 - (b) Is the time spent on other behaviours the same inside and outside?
- (4) What are the relationships between dolphins inside and those outside?
 - (a) Genetic and photo-identification work.
- (5) What are the characteristics (diversity/abundance) of faunal and floral resources inside and outside the PA?

If the southern African experience is anything to go by, many of the PAs established do not fulfil a useful role for coastal marine mammals. Yet, many of the recommendations arising from marine mammal research (conservation biology) propose the establishment of PAs, but little consideration is given to what is required for a PA to be effective!

As the needs for different cetacean species will vary, so the specifications for the protected area will differ. This has serious implications for the concept of coastal reserves, especially if there has been little background research on their viability for the dolphin species that they are meant to conserve! But what about oceanic species? It seems inevitable that the marine environment will increasingly suffer the same fate as the terrestrial environment and be partitioned into conservation or natural areas and exploitable zones. But how do we define oceanic protected areas? Should they be modelled on defined areas, as terrestrial refuges are, or should they be more liberally defined, to encompass isobath boundaries, as for coastal dolphins, or temperature boundaries? These questions will need to be addressed in future marine mammal conservation proposals.

REVIEW OF WHALE SANCTUARIES AROUND THE WORLD: A PROGRESS REPORT

C. A. Carlson* and V. Papastavrou**

*PO Box 32, Provincetown, MA 02657, USA

** University of Bristol, Bristol, B58 1UG, UK

Marine protected areas can play a key role in an integrated approach to the conservation of whales. A view of the current international status and the future outlook for marine protected areas may be achieved by reviewing the existing marine area and the progress in establishing new ones.

The International Fund for Animal Welfare is in the process of collecting available information on existing and proposed whale sanctuaries around the world. Information on the legal status, date of declaration, benefits in stimulating benign research, whale tourism and benefits to conservation on each sanctuary are reviewed and collated. Also included is an assessment of proposed sanctuaries in other areas, including the Mediterranean, the Southern Ocean and the Olympic Coast of Washington State.

Information on whale sanctuaries has been received from Argentina, Australia, Brazil, Canada, the Dominican Republic, the Galapagos Islands, Ireland, Italy, Mexico, New Zealand, the Seychelles Islands and the United States.

The purpose of this paper is to present the information collected to date and to seek help with filling the gaps in our knowledge of such protected areas.

THE USE OF A WILDLIFE SANCTUARY IN NORTHWEST GREENLAND BY NARWHALS

M. P. Heide-Jørgensen and R. Dietz

Marine Mammal Section, Greenland Fisheries Research Institute,
Tagensvej 135, 2200 Copenhagen N, Denmark

Denmark and Greenland Environmental Research Institute,
Tagensvej 1135, 2200 Copenhagen N, Denmark

Narwhals (*Monodon monoceros*) are hunted throughout Northwest Greenland. There are at present no quotas, but there are regulations of hunting gears in certain areas and hunting is restricted to Inuit with hunting as the primary occupation. Two other factors contribute to the protection of narwhals against over-exploitation in Greenland:

(1) Aerial surveys have consistently documented the widespread distribution on Narwhals in the inaccessible pack ice in central Baffin Bay. In this habitat narwhals are difficult or impossible to find and pursue;

(2) Satellite tracking has recently revealed that a wildlife sanctuary in the Melville Bay is important for protecting narwhals from exploitation.

A part of the Baffin Bay population of narwhals spends at least two months of the open water season feeding within the Melville Bay sanctuary, before moving to the off-shore pack ice in late October.

In both areas the narwhals make daily dives to depths of more than 500m and often to 1,000m, which is the maximum range of the depth transducers we have deployed. One of the whales moved south towards Davis Strait following a narrow slope at the 500-1,000m depth contour.

Data from coastal catches of narwhals indicate that they are primarily feeding on shrimps, *Pandalus* sp., and polar cod (*Boreogadus saida*), in the open water season and on squids in winter.

IRELAND - A SANCTUARY FOR WHALES AND DOLPHINS: THE IMPLICATIONS OF IRELANDS' SANCTUARY DECLARATION

Simon D. Berrow and Emer Rogan

Irish Whale and Dolphin Group, c/o Department of Zoology,
University College, Cork, Ireland.

INTRODUCTION On 7th June 1991 the Irish Government declared Irish waters a whale and dolphin sanctuary. This Declaration was in conformity with the Government's Environmental Action Plan Programme and the Dublin Declaration on the Environment which was adopted by the European Council during Ireland's Presidency of the European Community in June, 1990. It was heralded as "a clear indication of Ireland's commitment to contribute to the preservation and protection of these magnificent creatures in their natural environment, and to do everything possible to ensure that they should not be put in danger of extinction but should be preserved for future generations".

Irish waters are important for cetaceans. Breeding and feeding grounds for dolphins, porpoises and some smaller whale species have been identified off the Irish coast while many of the larger whale species migrate annually through Irish waters. To date, twenty-three species of cetaceans have been recorded in Ireland, including some of the rare beaked whales. Ireland has a history of exploitation of cetaceans. In 1760, a whale and shark fishery started off County Donegal and in 1908, two Norwegian owned whaling companies were established in Northwest Ireland, killing at least 818 whales (mainly fin, sei and sperm whales) between 1910 and 1923, mostly in the summer months.

LEGISLATION PROTECTING CETACEANS IN IRELAND The protection of cetaceans in Irish waters is covered by the Whale Fisheries Act of 1937, the Wildlife Act of 1976 and an amendment to the Whale Fisheries Act in 1982. The Whale Fisheries Act of 1937 prohibits the hunting of baleen whales within the exclusive fishery limits (200 miles) of the State. However, it was not until 1982 that this act was extended to protect all species of cetaceans, including dolphins and porpoises within this area. The Wildlife Act of 1976 also protects cetaceans from being hunted but it provides additional protection to the Whale Fisheries Acts by protecting them from "wilful interference", including interference with their habitat and destruction of their breeding places. However, this Act only covers the area 12 miles from the coast. Since 1985, Ireland has been a member of the IWC and signatory to the International Convention for the Regulation of Whaling. Ireland has also ratified the Convention on the Conservation of Migratory species of Wild Animals (Bonn Convention), the Convention on the Conservation of European Wildlife and Natural Habitats (Berne Convention), and the EC Directive on the Conservation of Natural Habitats and is expected to ratify the CITES soon. The sanctuary declaration would be progressive if bound in Irish law as it attempts to afford habitat protection within the 200 mile exclusive fishery limits.

IMPLICATIONS OF SANCTUARY DECLARATION The most immediate impact of the sanctuary declaration has been an increase in public awareness of the presence of cetaceans in Irish waters. With the sanctuary declaration and the realisation that whales, dolphins and porpoises are found in Irish waters, people want to see cetaceans and a whale-watching industry is now being actively developed. An estimated 150,000 people visit Dingle, County Kerry annually to see and swim with a wild sociable bottlenose dolphin (*Tursiops truncatus*) and with trips now available at other locations in Ireland, whale-watching generates around £1.2 million IR annually. Increasingly, people want to learn more about cetaceans and become actively involved in their conservation. Education packs on cetaceans and marine life are being prepared for schools and a major exhibition on whales and dolphins is currently underway in Dublin. The Irish government is now actively

supporting international initiatives to conserve cetaceans and may, as a member state of the European Union, propose a similar sanctuary declaration for European waters as a whole.

Management of the whale and dolphin sanctuary will require the monitoring of cetaceans in Irish waters, and research into potential threats. A stranding and sighting scheme has been established since 1990 and is expanding annually. There is no direct take of cetaceans in Irish waters so indirect threats need to be identified and quantified before effective management can be carried out. The sanctuary declaration has encouraged research funding and attracted international interest in carrying out research in Ireland. Since the declaration, a study into contaminant levels and biology of dolphins and porpoises has been initiated. The impact of the fishing industry on cetacean populations both directly through entanglement and from competition for resources is one of the more sensitive issues affecting the management of any sanctuary. Since the sanctuary declaration, studies of incidental capture in gill-net fisheries have been carried out with the full co-operation of the fishing industry. The effect on cetaceans of over-fishing of fish stocks has yet to be established.

The whale and dolphin sanctuary declaration in Ireland has been an important step in the conservation of cetaceans in Irish waters. The ecology of cetaceans in Ireland is poorly understood but the sanctuary declaration has demonstrated government recognition of the diversity and importance of Irish waters for these animals. Many cetacean species range over large areas, cross national boundaries and inhabit international waters. Without creating the will to protect these species, many conservation efforts will fail. The sanctuary declaration has been important in generating the desire to protect cetaceans in Ireland and with time may enable us to provide true sanctuary for cetaceans in Irish waters.

**ZONATION AND REGULATIONS FOR A MARINE NATIONAL PARK
PROPOSED FROM FIELD STUDIES OF HABITAT USE BY RESIDENT MARINE
MAMMALS : THE EXAMPLE OF THE PROJECT
PARC NATIONAL MARIN DE L'IROISE, BRITTANY, FRANCE**

P. Creton*, P. Allali*, C. Guinet**, C. Liret* and V. Ridoux*

* OCEANOPOLIS, Département Mammifères Marins,
BP411, Brest 29275, France

** Current address: CEBC/CNRS, Villiers en Bois,
Beauvoir s/s Niort 79360, France

INTRODUCTION At the western tip of Brittany lie the islands of Molène and Ouessant with their surrounding islets and rocky reefs. Seabird colonies, halophytic vegetation, marine mammals and both diverse and well preserved marine habitats are the most conspicuous features of the local natural environment. The archipelago has long received the attention of conservationists and wildlife managers resulting in a variety of conservation status including private islands, game reserves, regional natural park, natural reserves and a "Man And Biosphere" reserve. On the other hand, some terrestrial areas and the entire marine habitat surrounding the islands remain unprotected.

In an attempt to unify and reinforce this conservation status and to extend its implementation to the marine environment, it has been suggested that a marine national park called *Parc National Marin de l'Iroise* could be created here. Preliminary studies are currently being carried out to assess more carefully the biological value of the area as well as the current level of human activity and its consequences on the environment. These studies are ultimately aimed at defining the zonation and the regulations of the "Man And Biosphere" reserve taking into account the principle of sustainable development for the local villages. The zones thus defined will probably encompass the core of the future Marine National Park.

In this context, we have mapped habitat utilisation by the resident populations of bottlenose dolphins (*Tursiops truncatus*) and grey seals (*Halichoerus grypus*), paying particular attention to seasonal variations in haul-out sites of grey seals and activity patterns of bottlenose dolphins.

MATERIALS AND METHODS For the purposes of this study, we have focused on haul-out sites because they are places where seals are the most vulnerable to disturbance. Seals have been censused once every fortnight during a two-year-long survey. Space utilisation by bottlenose dolphins has been mapped in the summer because this is the season during which they are most exposed to tourist pressure. The intensity of habitat use has been mapped by tracking the pod of dolphins from a rubber boat. Human activity was also mapped in the vicinity of the areas where marine mammals commonly dwell. These activities mostly include seaweed harvesting, sailing and craft fishing.

RESULTS The most important seal haul-out sites are concentrated in the southern part of the archipelago (Fig. 1). Furthermore, it has been evidenced that 90% of the seals use haul-out sites that are not connected to the islands; the vast majority of them prefer isolated rocky reefs, only emerging at low tide. Therefore, the current protection status of several of the islands is of no value for the seals.

Bottlenose dolphins concentrate their activity in a crescent shaped area along the south-west side of the archipelago (Fig. 2). The total surface area of their summer home range is about 70 km² and is almost entirely included in the 10 m depth contour. The sites of highest

highest utilisation frequency (darker shading on the map) are seemingly used for foraging and are located close to various islands in areas of strong tidal current.

The present level of human activity appears to have a very low direct interaction with the resident populations of marine mammals. However, it is noticeable that the *Laminaria* kelp harvesting industry broadly overlaps with two important feeding zones of bottlenose dolphins (Fig. 3). Similarly shellfish and red seaweed harvesting also overlap with several haul-out sites of great importance to the seals.

CONCLUSIONS: ZONING PROPOSALS "Man And Biosphere" reserves are generally divided up into areas of three distinct types :

- the core area where any human activity is prohibited except scientific monitoring;
- the buffer area where some tourist and educational activities can be accepted;
- the peripheral area where any activity can be accepted provided that it does not hamper the aims of conservation in the core and buffer zones.

We propose to include the summer home range of the bottlenose dolphins and the majority of the grey seal haul-out sites in the buffer area (Fig. 4). To further improve protection on haul-out sites of grey seals, the core area could be defined as the parts of the buffer zone that emerge at low tide of coefficient 120.

It has been observed that the *Laminaria* kelp harvesting activity has no direct effect on the populations of marine mammals. However, it is suggested that an uncontrolled development of this industry could act on marine mammals through habitat degradation and consequent food depletion since it broadly overlaps with the foraging areas used by dolphins and most probably by seals also. Consequently, a detailed study is needed on this point to determine how this activity should be managed.

Another potential threat is the tourist industry which is currently very low and almost entirely localised on the two inhabited islands. Dolphin and seal watching is a burgeoning activity at present. However, it may be given a dramatic impetus by the creation of the "Man And Biosphere" reserve and the future marine national park, and also by the need for the insular villages to find new income for their maintenance; consequently it should be carefully developed.

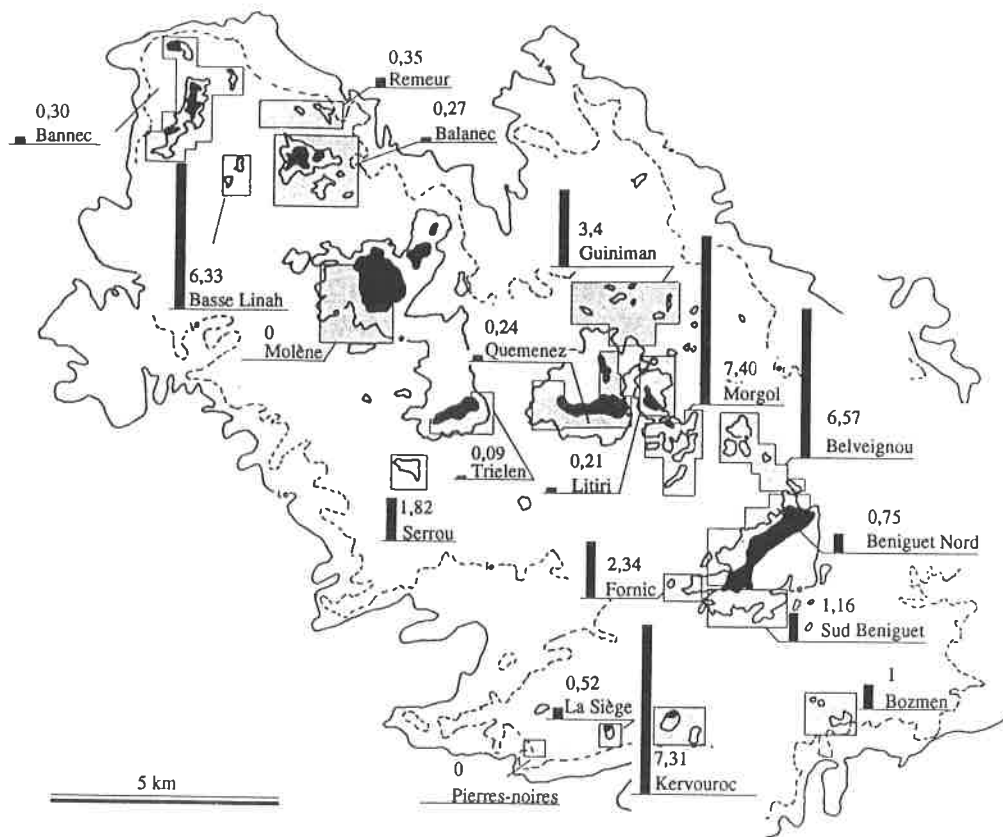

Fig. 1 - Distribution of grey seals haul-out sites

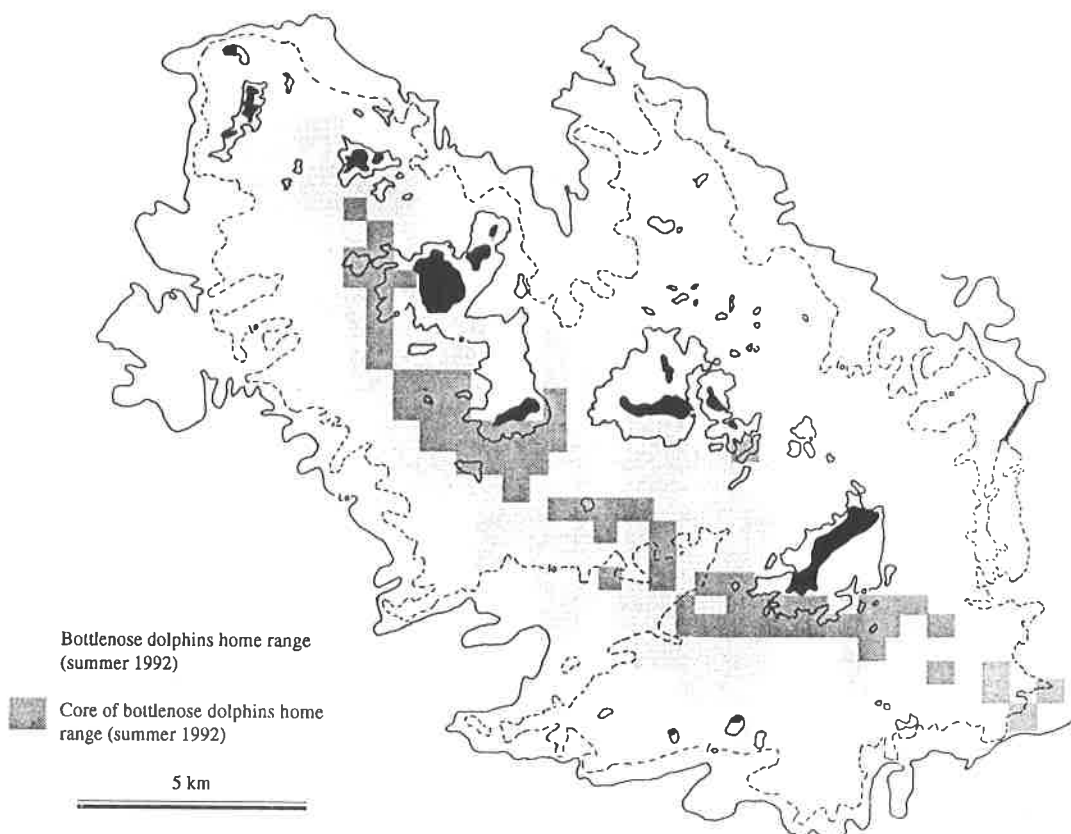

Fig. 2 - Summer distribution of bottlenose dolphins

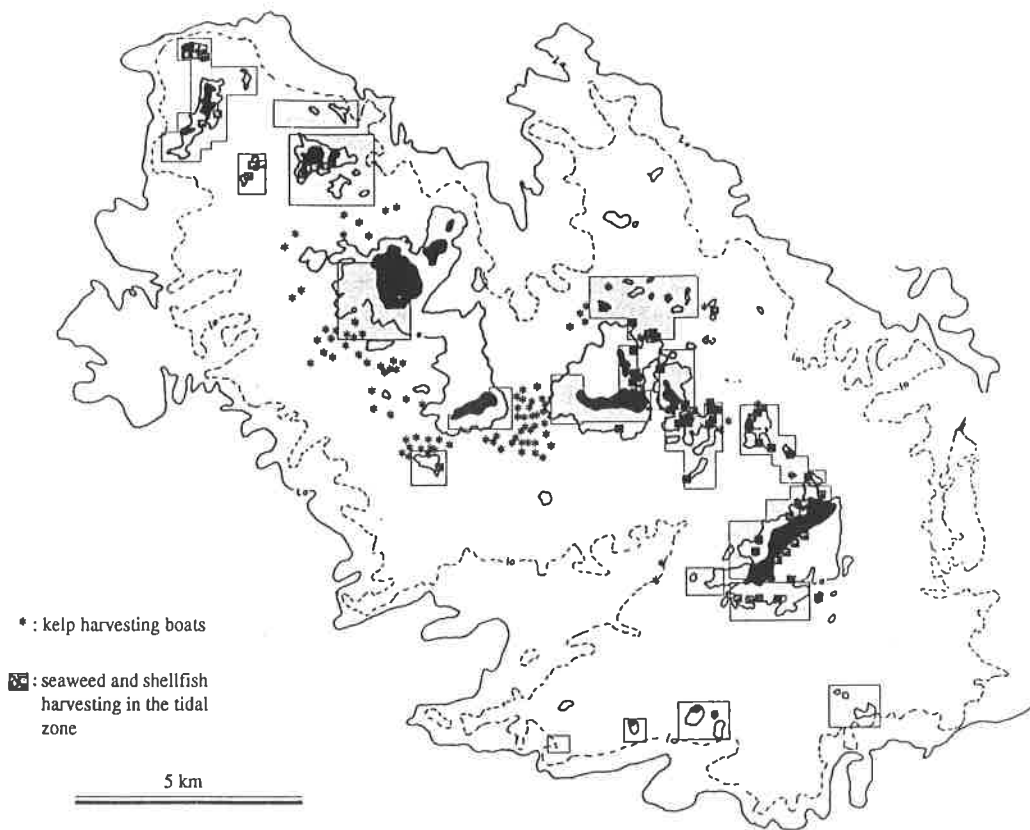

Fig. 3 - Space utilization by man

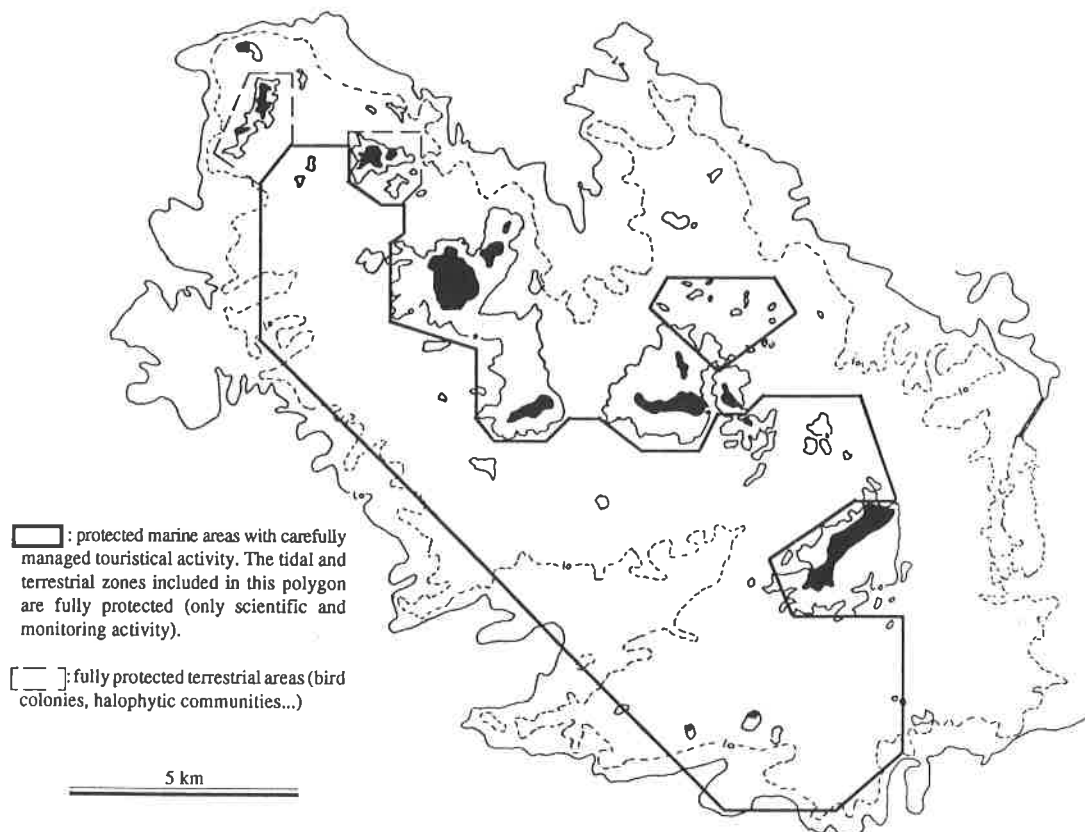

Fig. 4 - Zoning proposals

THE MEDITERRANEAN SANCTUARY FOR THE PROTECTION OF CETACEANS: A DIFFICULT TRANSITION FROM PAPER TO REALITY

Giuseppe Notarbartolo di Sciara

Tethys Research Institute,
via G. Giusti 5, 20154 Milano, Italy

INTRODUCTION On 22 March 1993, the Ministers of the Environment of France and Italy, and the Minister of State of the Monaco Principality, signed in Bruxelles a joint declaration for the institution of a Mediterranean sanctuary for marine mammals. The area of the proposed Sanctuary, approximately 70,000 km² wide, is defined by a portion of the continental coasts of France and Italy, the west coast of Corsica, and northwestern Sardinia (Fig. 1). The genesis and the rationale of the declaration are briefly described here, together with the difficulties involved in the actual implementation of the Sanctuary.

WHY A CETACEAN SANCTUARY IN THE CORSICAN-LIGURIAN BASIN?

The region comprising the Corso-Ligurian Basin and the Gulf of Lion is characterised by very high levels of primary productivity (Jacques, 1990), in contrast to the well-known generalised oligotrophy of the Mediterranean Sea. Accordingly, this region supports abundant marine life, including substantial epipelagic macrofauna populations. All cetaceans regularly observed in the Mediterranean can be found in the region, including pelagic species such as the fin whale (*Balaenoptera physalus*), sperm whale (*Physeter macrocephalus*), Cuvier's beaked whale (*Ziphius cavirostris*), long-finned pilot whale (*Globicephala melas*), Risso's dolphin (*Grampus griseus*), striped dolphin (*Stenella coeruleoalba*), common dolphin (*Delphinus delphis*); and coastal bottlenose dolphin (*Tursiops truncatus*) (Notarbartolo di Sciara, 1994). Results from previous surveys had emphasized that cetaceans in this region are substantially more abundant than in all other seas surrounding Italy (Notarbartolo di Sciara *et al.*, 1993b), and than the rest of the western Mediterranean basin (Forcada *et al.*, 1994). A line-transect survey conducted in the Corso-Ligurian Basin in summer 1992 produced an abundance estimate of 830 fin whales and of about 33,000 striped dolphins (Notarbartolo di Sciara *et al.*, 1993a). However, considerable threats exist for cetacean populations living in the region, including, among others: bycatch in driftnet fishing activities (Podesta and Magnaghi, 1989; Notarbartolo di Sciara, 1990); presence of substantial amounts of toxic xenobiotics in the trophic chain, which accumulate in the cetaceans' fatty tissues (Focardi *et al.*, 1992), and may have facilitated the outbreak of a massive striped dolphin epizootic in the Mediterranean in 1990-1992 (Aguilar and Raga, 1993); finally, high levels of maritime traffic, including ships transporting hazardous chemicals (Relini, 1994) to and from the region's commercial harbours, and offshore yacht races.

It is unfortunate that the peculiar international legislation regulating human activities on the Mediterranean high seas, at distances from the coastline greater than 12 nautical miles - where Exclusive Economic Zones were never created - is preventing today a rational management of its pelagic resources, and a regular monitoring of their conservation status. The proposal of creating a sanctuary where cetaceans and other pelagic life are specially protected should therefore be viewed as a challenge to the inadequacy of the existing international laws.

PROGRESSIVE STEPS TOWARDS THE DECLARATION The main impetus for the proposal of a cetacean sanctuary in the region was provided by the evidence found in 1988 and 1989 of a massive and widespread slaughter of pelagic cetaceans, by-caught in the Italian swordfish driftnetting operations (Podesta and Magnaghi, 1989; Notarbartolo di Sciara, 1990). Pressure from public opinion in Italy and France induced the Italian Government in 1990 to introduce unilateral restrictions to driftnetting in an area between eastern Liguria, Cape Corse and Antibes (France), (Orsi Relini *et al.*, 1992). However,

eastern Liguria, Cape Corse and Antibes (France), (Orsi Relini *et al.*, 1992). However, because of its narrow goal and limited geographic range (which excluded from protection the region where cetacean abundance was greatest), such a move was considered insufficient, and proposals for the creation of a wider conservation and management framework were presented by a number of organisations in Italy and France, including Greenpeace and Europe Conservation. Among these proposals, the Pelagos Project, commissioned in 1990 by the "European Association Rotary for the Environment" to the Tethys Research Institute, envisaged the creation of a Biosphere Reserve in the Corsican-Ligurian Basin, and of an international, Monaco-based authority, responsible for the sustainable management of the basin's natural resources (Notarbartolo di Sciara and Ausenda, 1991; Notarbartolo di Sciara *et al.*, 1992). A similar concept was later proposed by R.I.M.M.O. (Réserve Internationale Maritime en Méditerranée Occidentale), a private organisation created in Antibes in 1992.

THE JOINT DECLARATION In autumn 1992, during a meeting of Europe's Environment Ministers in Edinburgh, an informal consensus was reached between the representatives of France and Italy to jointly proceed towards the creation of an International Sanctuary for cetaceans in the Corsican-Ligurian Basin, admittedly inspired by the Pelagos Project. Such an intention met the full support of the Monaco Principality, which had strongly favoured the initiative since the official presentation of the Pelagos Project (Monaco, March 1991). The resulting joint declaration proposes the creation of a management authority, responsible for the favourable conservation status of marine mammals in the area by protecting them and their habitats from direct or indirect negative impacts (Article 5). In the proposed Sanctuary, all direct takes and intentional harassment of marine mammals will be forbidden, and potentially invasive research activities and whale-watching will be regulated; large-scale pelagic driftnet fishing will be banned; off-shore competitions will be limited and eventually forbidden; and special efforts will be made to control and curb pollution.

THE PRESENT SITUATION After almost two years from the date of the declaration, no significant move has been made towards the implementation of any of its objectives. This may in part be due to the intrinsic difficulties presented by the actual lack of appropriate international legislation (Scovazzi and Orsi Relini, 1993), and in part to a possible absence of political interest towards the issue by the successive Administrations both in France and Italy. This brief description is best concluded by quoting Resolution 19.92, *Establishment of a Marine Sanctuary for Large and Small Cetaceans in the Ligurian Sea, Western Mediterranean*, adopted by the General Assembly of IUCN (Buenos Aires, Jan. 1994): "The General Assembly of IUCN recommends that the Governments concerned, and the entire international community, should give effect to the intention thus expressed with a view to the protection of this area and these species by officially declaring the creation of this sanctuary and instituting the necessary procedures for turning it into a marine reserve for the western Mediterranean".

REFERENCES

- Aguilar, A. and Raga, J.A. 1993. The striped dolphin epizootic in the Mediterranean Sea. *Ambio*, 22(8): 524-528.
- Focardi, S., Marsili, L., Leonzio, C., Zanardelli, M. and Notarbartolo di Sciara, G. 1992. Organochlorines and trace elements in subcutaneous blubber of *Balaenoptera physalus* and *Stenella coeruleoalba*. Pp. 230-233. In *European Research on Cetaceans - 6* (Ed. P.G.H. Evans). Proc. 6th Ann. Conf. ECS, 20-22 February 1992, San Remo, Italy. European Cetacean Society, Cambridge, UK.
- Forcada, J., Aguilar, A., Hammond, P.S., Pastor, X. and Aguilar, R. 1994. Distribution and numbers of striped dolphins in the western Mediterranean Sea after the 1990 epizootic outbreak. *Mar. Mamm. Sci*, 10(2): 137-150.
- Jacques, G. 1990. L'oligotrophie du milieu pelagique de la Mediterranée occidentale: un paradigme qui s'estompe? *Bull. Soc. Zool. France*, 114(3): 17-30.
- Notarbartolo di Sciara, G. 1990. A note on the cetacean incidental catch in the Italian driftnet swordfish fishery, 1986-1988. *Rep. Int. Whal. Commn*, 40: 459-460.
- Notarbartolo di Sciara, G. 1994. La cetofauna del bacino corso-liguro-provenzale: rassegna delle attuali conoscenze. *Biol. Mar. Medit.*, 1(1): 95-98.
- Notarbartolo di Sciara, G. and F. Ausenda. 1991. Il Progetto Pelagos: proposta di istituzione di Riserva della Biosfera nel Bacino Corso-Liguro-Provenzale. Report to the European Association Rotary for the Environment. 74 pp.
- Notarbartolo di Sciara, G., Ausenda, F., Relini, G. and Orsi Relini., L. 1992. Una proposta di gestione dell'ambiente pelagico: la riserva della biosfera nel bacino corso-ligure provenzale. *Oealia*, Suppl. 17: 517-521.
- Notarbartolo di Sciara, G., Forcada, J., Acquarone, M. and Fabbri, F. 1993a. Population estimates of fin whales and striped dolphins summering in the Corso-Ligurian Basin. Pp. 135-138. In *European Research on Cetaceans - 7* (Ed. P.G.H. Evans). Proc. 7th Ann. Conf. ECS, 18-21 February 1992, Inverness, Scotland. European Cetacean Society, Cambridge, UK.
- Notarbartolo di Sciara, G., Venturino, M.C., Zanardelli, M., Bearzi, G., Borsani, J.F. and Cavalloni, B. 1993b. Cetaceans in the Central Mediterranean Sea: distribution and sighting frequencies. *Boll. Zool.*, 60: 131-138.
- Orsi Relini, L., Relini, G. Cima, C., Fiorentino, F., Palandri, G., Relini, M., and Torchia, G. 1992. A biological protection area and a marine park for cetaceans in the Ligurian Sea. *Boll. Mus. Ist. Biol. Univ. Genova*, 56-57: 247-281.
- Podesta, M. and Magnaghi., L. 1989. Unusual number of cetacean bycatches in the Ligurian Sea. Pp. 67-70. In *European Research on Cetaceans - 3* (Ed. P.G.H. Evans). Proc. 3rd Ann. Conf. ECS, 24-26 February 1989, La Rochelle, France. European Cetacean Society, Cambridge, UK.
- Relini, G. 1994. Gli ecosistemi e le risorse biologiche del Mar Ligure dopo il disastro della Haven. *Biol. Mar. Medit.*, 1(1): 3-42.
- Scovazzi, T. and Orsi Relini., L. 1993. The declaration of a Sanctuary for the protection of marine mammals in the Mediterranean: legal and biological aspects. *ICCOPS Newsletter*, 1: 9-11.

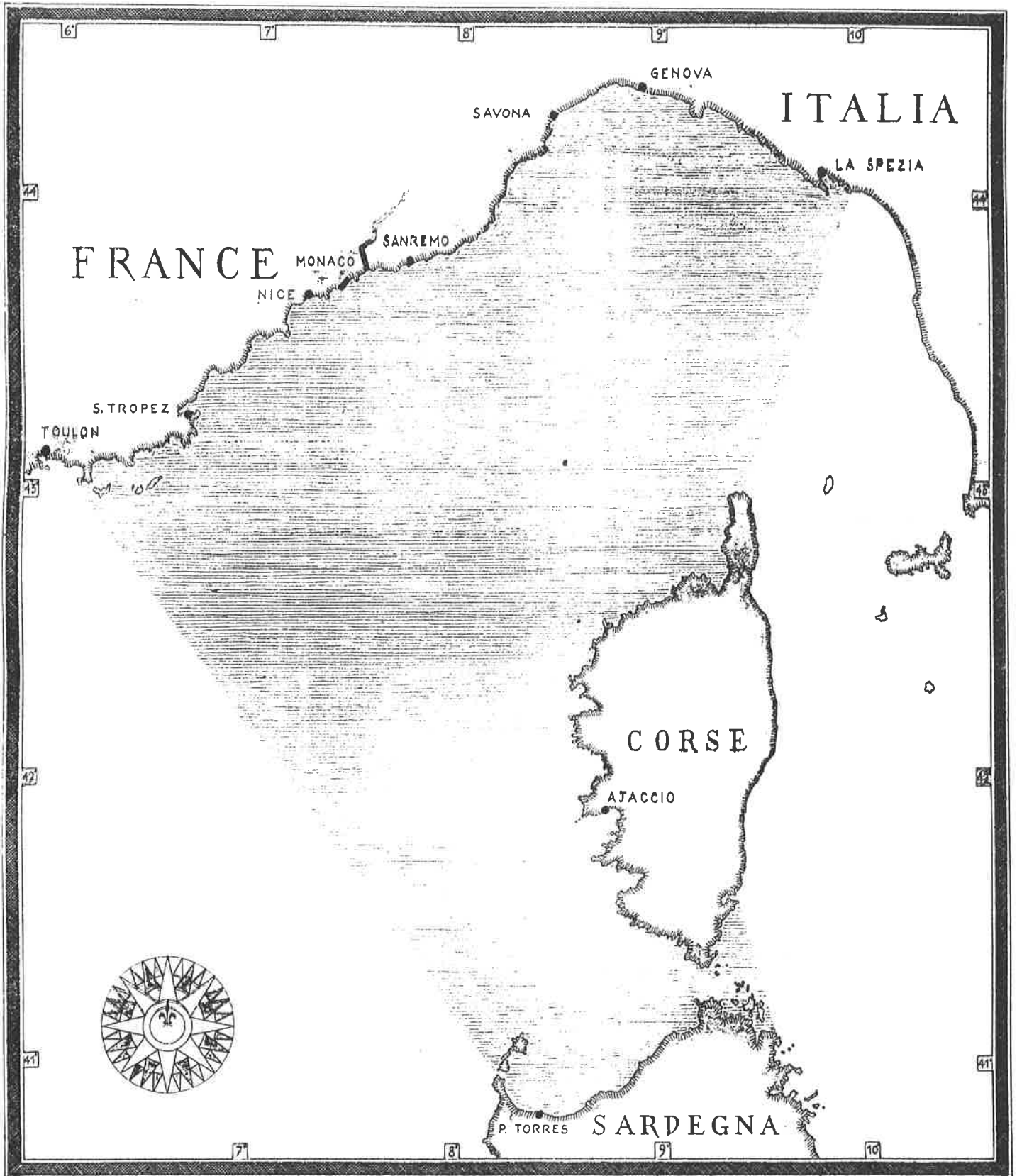

Fig. 1 Map of Proposed Mediterranean Sanctuary for Marine Mammals

THE UKRAINIAN NATIONAL PROGRAMME FOR THE CONSERVATION OF BLACK SEA DOLPHIN POPULATIONS

Alexei Birkun, Jr.* and Nikolai Stetsenko**

*BREMA Laboratory, Simferopol, Crimea 333720, Ukraine

**Ministry of Environmental Protection of Ukraine, Kiev 252001, Ukraine

INTRODUCTION During recent years, all three Black Sea cetacean subspecies were included in the Ukrainian National Red Data Book: bottlenose dolphin (*Tursiops truncatus ponticus* Barabasch-Nikiforov, 1940) in 1989; harbour porpoise (*Phocoena phocoena relicta* Abel, 1905) and common dolphin (*Delphinus delphis ponticus* Barabasch-Nikiforov, 1935) in 1993. Under the Animal World Law of Ukraine (1993), and according to the statute of the Ukrainian Red Data Book (1992), endangered species must be protected by appropriate governmental programmes. So in 1993, the Ministry of Environmental Protection of Ukraine asked the BREMA Laboratory to prepare a draft National Programme for the conservation of Black Sea dolphin populations.

AIM OF PROGRAMME To establish a state system of research and practical actions for the protection of cetacean populations in the Black Sea and in the Sea of Azov.

PROGRAMME'S DIRECTIONS

(1) Creation of population monitoring system

- resumption of estimates of cetacean population numbers, distribution and migrations from coastal stations, ships and aircraft;
- elaboration of new methods for population observations (electronic tagging, radio-tracking, satellite techniques);
- resumption of regular controls on incidental catches and other kinds of human-associated damage to wild animals;
- expansion of searches for dolphin strandings and floating carcasses and registration of live sick and traumatised animals;
- multi-disciplinary investigation of mortality patterns and dynamics, causes of death, diseases and anthropogenic injuries;
- investigation of cetacean nutrition patterns and estimation of food resources;
- research on resident dolphin schools (quantity, location, species, social and individual structure, etc.);
- elaboration of mathematical models of population dynamics;
- organisation of cetacean monitoring scheme and a Black Sea marine mammal research centre.

(2) Organisation of protected areas for resident dolphin populations and mass migration routes

(3) Creation of a rescue-rehabilitation-reintroduction scheme

- elaboration of true criteria for rescue and rehabilitation actions;
- elaboration of rescue techniques and veterinary assistance methods for stranded, by caught, sick and traumatised dolphins;
- elaboration of tagging, tracking, re-acclimatising and releasing techniques for rescued and rehabilitated animals;
- organisation of a cetacean rescue service (dolphin ambulance) and marine mammal rehabilitation centres (on the basis of reconstruction of existing facilities).

(4) Genetic resource preservation and captive breeding

- investigation of Black Sea dolphins' genetic and reproductive features;
- perfection of cryoconservation techniques for creation of a dolphin gene bank;
- elaboration of artificial insemination techniques and perfection of breeding technologies;
- organisation of a breeding station (dolphin nursery);

- relocation of existing captive animals (breeding groups) to better equipped facilities;
organisation of Black Sea cetacean reserves in geographically dispersed regions.

(5) Elaboration of dolphin-safe fishing gears and other marine exploitation technologies.

(6) Creation of a common multidisciplinary database on Black Sea dolphin research, conservation and management; formation of cetacean museum collections.

(7) Perfection of a marine mammal judicial defence

- signing of the convention on the Protection of Wild Fauna and Flora and Natural Habitats in Europe;
- ratifying of the Convention for International Trade of Endangered Species;
- signing of the agreement on the Conservation of Small Cetaceans of the Mediterranean and the Black Sea and Contiguous Waters as part of the Convention on the Conservation of Migratory Species of Wild Animals;
- revision of existing national and Black Sea regional and environmental and resource exploitation acts to ensure dolphin protection;
- preparation of national rules and standards for regulation of man/dolphin interactions in wildlife and captivity.

(8) Participation in international programmes

- joining the UNEP's Global Action Plan for the Conservation, Management and Utilisation of Marine Mammals;
- inclusion of dolphin problems into the existing GEF, UNDP, UNEP and World Bank's programme 'Environmental Management and Protection of the Black Sea';
- initiation of the Pan-Black Sea Cetacean Research and Conservation Plan.

(9) Education and public awareness

- the formation of a nature protection outlook among young people, with children being attracted to dolphin conservation efforts;
- student and postgraduate specialisation in marine mammal research and rehabilitation centres;
- twinning of marine mammal specialists training (scientific and practical meetings, workshops, etc.);
- publishing of specialised and popular literature, and specific audio- and video productions;
- dolphin protection campaign for the mass media.

(10) Programme's funding mechanisms

- governmental grants;
- grants from international wildlife protection organisations;
- donations because of preferential duties and taxes for programme donors;
- penalty fees from poachers and destroyers of the marine environment;
- payments from organisations exploiting marine resources in general, and marine mammals in particular;
- profits as a result of special actions (festivals, raffles, etc.) and systematic trade (souvenirs, literature, etc.).

This draft was approved by 27 participants of the first Ukrainian Black Sea Cetacean Workshop (Kiev, 22 December, 1993). Some projects have already started and we hope that the programme as a whole will be ratified by the Ukrainian government in the near future. Presently the Ministry of Environmental Protection of Ukraine and the authors of this document are in need of any critical comments, remarks and proposals.

ACKNOWLEDGEMENTS We thank Dr. G. Notarbartolo di Sciara (Tethys Research Institute), Mr. D. Bowles (EIA) and Dr. J. Pearce (US Northeast Fisheries Center) for documents on marine mammal protection, used in our work.

WHALE-WATCHING WORLDWIDE: AN OVERVIEW OF THE INDUSTRY AND THE IMPLICATIONS FOR SCIENCE AND CONSERVATION

Erich Hoyt

29 Dirleton Ave., No. 11, North Berwick, Scotland, EH39 4BE

THE GROWTH OF WHALE WATCHING More than ten years ago, in 1983, I was asked to write a guidebook on watching whales and dolphins. The idea was to attempt to do for whale enthusiasts what had already been done so extensively for bird-watchers. At that point, I had spent ten summers watching *Orcinus orca* off Vancouver Island, Canada. So I started collecting information, talking to researchers, and travelling around the world for a book that would become *The Whale Watcher's Handbook*.

In those days, there were only about 12 countries practising any whale watching (defined as paid tours to see any species of cetacean, usually by boat but sometimes from land). Whale-watching grew slowly after its start in 1955 in southern California. The only whale-watching in Europe by 1983 were dolphin tours out of Gibraltar. Most of the industry was in North America. At a conference on the "non consumptive uses of cetaceans," held in Boston that year, the world-wide value of whale-watching was estimated at about \$4 million US in direct revenues (the cost of the tours) and \$14 million US in total revenues (including travel, accommodation, food and souvenirs), (Kaza, 1982; Kelly, 1983; Hoyt, 1984; Tilt, 1985a,b; Barstow, 1986) In 1988, Scott Kraus made estimates of \$38 to \$56 million US for total revenues (Kraus, 1989).

By 1992, when I researched the value of whale watching for a report to the Whale and Dolphin Conservation Society, it had spread to 30 countries plus Antarctica. Whale and dolphin watchers amounted to more than an estimated 4 million per year worldwide. And they were spending more than \$300 million US in total revenues per year. (Hoyt, 1992)

So we have seen an explosive growth in whale-watching during the late 1980s and early 1990s and that is partly what led to the whale-watching resolution put forward by Britain and adopted at the 1993 International Whaling Commission (IWC) meeting in Kyoto. The underlying strength of the argument that the IWC ought to become involved in whale watching was that, for some time, the most prevalent "use" of cetaceans among IWC members has actually been whale watching, not whaling, (Hoyt, 1993a).

In May 1994, the first working group focusing on whale-watching convenes in Mexico. Member countries have recently answered a detailed IWC questionnaire, gathering statistics to chart the growth of whale-watching. I have seen three countries' returns to date - Argentina, New Zealand and the UK - and in all three, the numbers of whale-watchers and the value of whale-watching has dramatically increased, even since 1992. At the same time, I have begun to look at the potential for whale-watching in many other countries outside the IWC. Over the past two years, at least ten more countries are now offering, or are about to offer, whale-watching tours, bringing the world-wide total to some 40 countries or island territories. In certain areas of North America (southern California, southern New England, Quebec and British Columbia), whale-watching is a mature industry, growing slowly if at all, but in other places, it is defying all expectations, growing by leaps and bounds (Hoyt, 1992; Duffus and Dearden, 1990).

Out of 4 million whale-watchers world-wide, 2.9 million (about 72 percent) go by boat, the rest (1.1 million) are land-based from lookouts mainly in California, Quebec, South Africa and South Australia (Hoyt, 1992; Trépanier *et al.*, 1989).

About 75% of whale-watchers come from continental USA, 9% from Australia and New Zealand, 6% from northern countries (Canada, Norway, Iceland, Greenland, Russia, and

Alaska), 4% from Hawaii, 4% from Europe outside of Norway, Iceland, and less than 2% from the rest of the world. Most whale-watching takes place within the IWC. In fact, only 200,000 out of 4 million is outside and that is mostly from Canada.

Ninety-four percent of cetacean watching is whale-based and only 6 percent is dolphin-based. Dolphin tours are growing in places like Japan, New Zealand and the Caribbean, but the large whales are still the biggest attractions. More than 77% of whale-watching is purely commercial (Hoyt, 1992).

As whale-watching expands, researchers, conservationists and wildlife managers will need to focus on enhancing the scientific, educational and conservation aspects. Some suggestions will be made as to how researchers, in particular, can use commercial whale watching, as well as how commercial whale watching can best incorporate science and scientists into their operations.

CASE STUDIES At Kaikoura, New Zealand, whale-watching of sperm whales and dusky, Hector's and other dolphins has transformed the local economy. Kaikoura was once called the "dole capital of New Zealand". In 1986, there was no whale-watching at all. Today, overall in New Zealand, four percent of their international tourists are now whale watchers. Kaikoura alone attracts 70,000 whale and dolphin watchers a year (30,000 of which are turned away due to bad weather or full boats). In New Zealand, there are now eight ports offering whale watching, with 41 operators holding permits (Hoyt, 1994).

At Península Valdés in Argentina, the number of whale-watchers looking for right whales has increased every year. In 1993, there were 34,000 visitors spending about \$28 million US in total revenues. About a quarter of these tourists are from outside the country, mainly North America and Europe. This brings substantial foreign currency into the country. Most of the rest are from Buenos Aires, effectively transferring money from urban to rural areas of Argentina.

In Japan, whale-watching has exploded since 1988. There are now eight communities offering commercial tours. 19,000 people, mostly Japanese, went whale-watching in 1992 spending an estimated \$8 million US in total revenues (Hoyt, 1993b). The intriguing thing about all these examples is that local communities are undergoing profound changes because of cetaceans.

IUCN and WWF have made a big and sometimes controversial push to make wildlife pay for itself, and they and others have tried to point out that there are a great number of hidden values, too. All of these have to go into the equation. The tangible economic values for whale watching are the tourism revenues. Some of the less tangible values are having a platform for research as well as having a local public better educated about the sea and more sympathetic toward conservation. It is difficult to put an economic value on some of these intangibles though it would certainly be considerable.

But in the case studies cited here, scientific research and the promotion of education and conservation have for the most part lagged rather seriously behind commercial development. If local people don't know about wildlife or properly understand the needs of wildlife, how can they conserve it? At Península Valdés, fewer than ten percent of the tours even offer a bare introduction and commentary on the whales. In Japan, the fast-growing whale-watching port of Ogata offers no educational or scientific background to whale-watchers. At Kaikoura, the level of education and the science is better, with ID photos sometimes exchanged with local universities. But it is nevertheless minimal, especially considering the number of hours the tour boats spend at sea.

Kaikoura is now planning a marine centre which will help with the educational aspect, and the Department of Conservation is levying a head tax equivalent to \$1 US dollar to help fund research. But there are other examples of substantial wasted opportunities for science,

education and conservation, such as in the Canaries and Hawaii, which to date have had very few educational and scientific values as part of commercial whale watching.

Those engaged in field research with living whales are urged to get involved, to a greater degree in commercial whale watching. There are several ways in which that can be done. Four examples are presented here in order of the degree of commitment and the difficulty of putting it into action:

The **first** and most involved approach is to set up one's own whale-watching business. Richard Sears and his team, working with blue and other whales in the Gulf of St. Lawrence, Canada, raise virtually all of their research funds from whale-watching, but this requires considerable business and public relations skills, and a larger team or staff, with all the attendant logistical problems.

Second, is the Center for Coastal Studies approach. The researcher offers to act as a naturalist for a tour company, guiding them to the whales and talking to whale-watchers and answering questions, in exchange for a platform for research, possibly some funds, and hopefully the opportunity to have some input into the conduct of whale-watching. The Center for Coastal Studies was set up as a research and educational institution with close ties with commercial whale-watching maintained through the *Dolphin* fleet.

The arrangement works as follows: The Center provides naturalist guides for the boats. They are paid a basic amount for helping to direct the boat to the whales and for giving an informal, educational lecture and for answering the endless questions. The Center is allowed to sell T-shirts and other merchandise on board. Most important, Center researchers can also conduct their own photo-based research in the process, and often collect other data. Sometimes more than one researcher will come aboard so that maximum use of boat time is achieved.

This key partnership between science and commerce has determined the course of whale watching as well as the practice of whale research throughout New England. It has ensured that whale-watching is scientifically, educationally, as well as commercially, important. It has set a high standard. Of the 21 whale-watching operators here that mainly go to Stellwagen Bank/Jeffreys Ledge off Massachusetts, all but three advertise naturalists guiding their boats to the whales and lecturing whale watchers, although only about seven (33 percent) actually regularly carry bonafide researchers on board. Three others (15 percent) regularly provide photographs to help research even if they do not do research themselves. So about half are taking and contributing ID photos. the North Atlantic Humpback Whale Catalogue, a photo catalogue and data base which currently includes approximately 7,000 individual whales (Lien and Katona, 1990). As a measure of the scientific value of whale-watching here, at least 30 published papers in refereed journals have come from whale-watching on Stellwagen Bank.

The economic value of having a whale-watching boat as a platform for research has been estimated at \$1,000 US a day. Over a season, if each boat goes out a minimum of 125 days per year to conduct photo-ID and other research in the course of whale watching, then the annual value to an individual researcher or research team is \$125,000 US . If seven boats from the seven operations conducting the best science on Stellwagen Bank represent the minimum contribution to the scientific effort, then commercial whale watching's contribution as a platform for scientific research is at least \$875,000 US a year (Pett *et al*, 1990; Tilt and Ramage, 1985; Hoyt, 1994).

The **third** approach I recommend is to take advantage of an organisation like Earthwatch. The trick here is to design a project in which volunteers will pay to participate and actually do some real work and not just require babysitting that distracts from the research. In fact, there are several other companies besides Earthwatch that are now doing field study tours using the same basic formula but on a smaller scale, including Oceanic Society Expeditions in California and Wolftrail in the Netherlands. Of course, not all research projects lend

themselves to this approach, but Randall Wells' long-term studies with *Tursiops* off Sarasota, Florida, or Ken Balcomb's photo-identification and sighting studies in Washington State, off Australia and in the Bahamas, are examples of successful Earthwatch programmes. The Oceanic Society offers excellent river dolphin tours in Nepal and Peru, and are also starting what they hope will become regular dolphin tours along the eastern coast of Venezuela.

The Earthwatch approach requires that the researcher be a good manager of people and part of that is being flexible. Some researchers just don't have the temperament or inclination. But for those who do, it can be a creative way to get some work done, and to raise some extra funds for the field season.

Finally, there is the informal, "friendly exchange" approach. One may not want to, or be *able* to, work regularly on commercial whale-watching boats but can agree to make certain exchanges, for example by offering lectures to potential whale-watching tourists before they go to sea, teaching operators how to make recordings or take good, sharp ID photographs at sea. Whale-watching boats may also be encouraged to keep better log books, and to report strandings and unusual sightings. This effort can also be extended to the interested public, as in the orca census study and telephone hotline, set up by Michael Bigg in British Columbia in the early 1970s, and later in Washington State (Bigg *et al.*, 1987).

When Jim Darling was leading a National Geographic Society-sponsored study of humpbacks around Hawaii in the late 1970s and early 1980s, US regulations came in to control the whale-watching there that threatened the researchers' ability to get photo-ID shots and to sex the whales, etc. Competitive aggression among whale-watching tour operators and resulting disturbance of the whales contributed to the US National Marine Fisheries Service bringing in some stiff regulations for maintaining a distance from the mothers and calves, with some prosecutions. Since then, a more difficult research situation has prevailed, with permits required. In effect, this was the price for the researchers not getting involved enough in commercial whale-watching (Atkins *et al.*, 1988).

THE IMPACT OF WHALE-WATCHING TOURISM AND SCIENCE ON PROTECTED AREAS The impact of 15 years of data, collected by the Center for Coastal Studies and others in New England, became evident during the almost 10-year effort to secure protected status for Stellwagen Bank. In 1993, it was named the Stellwagen Bank National Marine Sanctuary. The whale-watching data did a number of things. US marine sanctuaries, similar to marine protected areas in other parts of the world, are usually multi-use areas that include fishing, shipping and marine tourism. Fishing is certainly an important activity on the bank, but the whale-watching data ensured that boundaries were drawn, as well, with the whales in mind.

Perhaps even more than all this, the sanctuary had a very large, committed group of supporters. In recent years, at least 400,000 people per year have gone whale-watching off southern New England, mainly on Stellwagen Bank. It has been at this level since at least 1985. So, perhaps four million people have seen whales on Stellwagen Bank over the years. Having scientists on board many of these boats, collecting data and telling their naturalist tales, has meant that a sizeable portion of these whale-watchers learned about the importance of Stellwagen Bank as a feeding ground for humpback and other whales. Therefore, conservation groups, as well as local politicians, did not have to worry about education and bringing the public up to speed on the sanctuary idea. And New England has a strong fishing community with a powerful lobby and many fishermen who already feel that they are being over-regulated. So the sanctuary may be viewed as a tribute to the tour companies and scientists who have worked together here to introduce local residents and visitors to the whales, and through the whales, to some of the complexities of ocean management (Pett *et al.*, 1990; Hoyt, 1994).

It is worth noting that a similar US Marine Sanctuary proposed for Hawaii's humpbacks did not succeed, even though, in many ways, humpback mating and calving grounds present a more sensitive situation that could use institutionalised protection. Commercial fishing is very important in Hawaii and the fishermen there opposed the reserve, vehemently and successfully. Probably the biggest difference between these two places was the overwhelming local support and solid documentation on Stellwagen Bank from a well-rounded whale-watching industry. That simply was not the case in Hawaii (Pett *et al.*, 1990).

To summarise, besides the direct benefits to scientists, scientific involvement through commercial whale watching can help to:

1. Build a data base, a body of useful base-line information,
2. Devise the best approach to whale-watching, lessening the chance that a situation dangerous to the whales or the whale-watchers will develop - i.e., to steer commercial development to some extent; and
3. Build a public committed to marine conservation.

What kind of whale-watching tours should be encouraged? This depends upon the area of the world, certainly, as well as the species of cetacean, the type of boat, and the scientific objective, if research is part of the picture. But, in general, the very best tours are probably general nature tours on which cetaceans *happen* to be seen. This is a more ecological approach to whale-watching tourism. It puts less pressure on the whales, and lessens the pressure on the operator to find a cetacean fast and to get close. Instead, prospective whale watchers can learn to enjoy bird and other marine life and learn about the ecosystem that whales and dolphins live in.

Whale-watching has the power, because of the public's strong attachment and interest in whales, not only to inform about cetaceans but also to foster an understanding and sympathy toward marine conservation. And through this awareness, the climate for supporting and funding research might also improve as well.

REFERENCES

- Atkins, N. and Swartz, S.L. 1988. *Proceedings of the Workshop to Review and Evaluate Whale Watching Programs and Management Needs*. Nov. 14-16. Monterey, California. Sponsored by Center for Marine Conservation and Office of Protected Resources, National Marine Fisheries Service, 53 pp.
- Barstow, R. 1986. "Non-consumptive utilization of whales". *Ambio*, 15 (3): 155-163.
- Bigg, M. A., Ellis, G. M., Ford, J. K. B., and Balcomb, K.C. 1987. *Killer Whales. A Study of Their Identification, Genealogy & Natural History in British Columbia and Washington State*. Phantom, Nanaimo, B.C. 79pp.
- Duffus, D. and Dearden, P. 1990. "Non-Consumptive Wildlife-Oriented Recreation: A Conceptual Framework." *Biological Conservation*, 53: 213-231.
- Hoyt, E. 1984. *The Whale Watcher's Handbook*. Penguin, Toronto & Doubleday, New York, (German editions 1987, rev. 1991). 208pp.
- Hoyt, E. 1992. "Whale Watching Around the World: A report on its value, extent and prospects." *International Whale Bulletin*, no. 7, summer, 8pp.
- Hoyt, E. 1993a. "Forum: Saving whales by watching them. Erich Hoyt believes we should consider the value of whales alive rather than on the slab." *New Scientist*, 138, (1872): 45-46.
- Hoyt, E. 1993b. *Kujira Watching. Whales and Dolphins: Alive and Being Watched Japanese-style*. Whale and Dolphin Conservation Society, Bath, UK, 16pp.

- Hoyt, E. 1994. *Whale Watching at the Community Level: Five Case Studies*. Whale and Dolphin Conservation Society, Bath, UK, 22pp.
- Kaza, S. 1982. "Recreational Whalewatching in California: A Profile." *Whalewatcher*, 16(1): 6-8.
- Kelly, J. E. 1983. The value of whale-watching. Whales Alive Conference, Boston. June 7-11. Unpubl. Report, 11pp.
- Kraus, S. D. 1989. "Whales For Profit." *Whalewatcher*, 23(2): 18-19.
- Lien, J. and Katona, S. 1990. *A Guide to the Photographic Identification of Individual Whales*. The American Cetacean Society and Breakwater, San Pedro, Calif. and St. John's, Newfoundland, 77pp.
- Pett, S., McKay, C. J. and Archer, J. H. 1990. *The Resources and Uses of Stellwagen Bank*, Part I: Technical Report on the Resources and Uses of Stellwagen Bank and Part II: Proceedings of the Stellwagen Bank Conference. Urban Harbors Institute, University of Massachusetts, Boston and Center for Marine Conservation, Washington, DC., [Two vols. bound together.] 77pp & 134pp.
- Tilt, W.C. 1985a. Whalewatching in California. An Industry Profile. Unpubl. Report, 17 pp.
- Tilt, W. 1985b. Whales and Whalewatching in North America with Special Emphasis on Whale Harassment. Yale School of Forestry and Environmental Studies, New Haven, CT. 109pp + appendices.
- Tilt, W. and W.T. Ramage III. 1985. Whalewatching in the southern Gulf of Maine. Yale School of Forestry and Environmental Studies, New Haven, CT. Unpubl. Draft. 9pp.
- Trépanier, S., G. Shooner, J. Therrien, and M. Breton. 1989. Étude socio-économique sur l'industrie d'observation des baleines au Québec. Unpubl. typescript. 42pp + Annexes.

WHALE-WATCHING AND ITS IMPACT ON MARINE MAMMAL RESEARCH

Richard Sears

Mingan Island Cetacean Study, Inc., 285,
Green, St-Lambert, Quebec, J4P 1T3

A clear link can be made between the emergence of whale-watching in the mid 1970s off the coast of New England and increased research on marine mammals, particularly cetaceans.

A vital marriage was consummated between researchers and boat operators. The researchers benefited from a cost-free platform from which to observe cetaceans at sea. And operators were able to attract knowledgeable biologists who could inform the public on the natural history of the animals observed. Those whale-watching operations that are linked to long term research projects are the most successful. In turn, the researchers have had a regular source of income, a platform (valued at \$1,000-1,500 per day) from which to carry out their studies, and they have benefitted from the sale of concessions such as T-shirts to the myriad tourists who embark on whale-watches.

The most successful whale-watching/research affiliations attract more than 100,000 passengers per year and gross from 1.8 to 2.7 million US dollars per season (April-October). The smaller operations attract only 15,000-20,000 passengers per season.

Of the 29-34 boats operating in New England waters, eighteen regularly provide data on marine mammal sightings through their own research programs or through naturalists who contribute their sighting data to researchers.

Researchers affiliated to whale-watching companies generally receive 10-15% of the funds generated by ticket and merchandise sale, as well as membership drives. Researchers who own whale-watching or ecotourism businesses are able to place 65-85% of the funds generated directly into their research.

In eastern Canada, the principal whale-watching area is found in the St. Lawrence, particularly in the estuary near the mouth of the Saguenay River. Thirty-four whale-watching boats are based here. However only two carry naturalists and collect data on marine mammal sightings. The remainder are purely commercial operations. The situation in the St. Lawrence Estuary is not nearly so well organised as in New England waters and much less research is generated.

Our research station, founded in 1979 and located in the Mingan Island region along the North Shore of the Gulf of St. Lawrence, has been financed principally through ecotourism since 1981. This tourism based business has enabled us to carry out long term studies of marine mammals five months a year over a fifteen year period.

Because the Canadian government has almost no interest in large whales and funds very little research into this area, it is essential that we fund ourselves through ecotourism.

It has enabled us to carry out long term studies of blue *Balaenoptera musculus*, fin *Balaenoptera physalus* and humpback *Megaptera novaeangliae* whales, based on photo-identification. We now have photographic catalogues of 405 humpback, 308 blue, and 345 fin whales for the Gulf of St. Lawrence. In addition, we have collected 348 biopsy samples from these species for genetic and toxicity studies. Our data are shared with researchers from eastern Canada to New England.

In summary, it is evident that whale-watching - when operated in concert with researchers in a responsible research/business association - has had an important and beneficial impact on the amount of knowledge collected on marine mammals, particularly cetaceans. Whale-watching and/or ecotourism has provided researchers with the opportunity to observe cetaceans with great regularity and significantly contributed to the funding of research.

COLLECTING SCIENTIFIC DATA ON WHALE-WATCHING PROJECTS. OPPORTUNITIES AND PROBLEMS

Jonathan Gordon*, Lex Hiby**, Phil Lovell**,
Vassili Papastavrou***, and Richard Fairbairns****

*Wildlife Conservation Research Unit, University of Oxford,
Department of Zoology, South Parks Road, Oxford, OX1.3PS
**Conservation Research Ltd, PO Box 114, Cambridge, CB4.1YJ
***Department of Zoology, University of Bristol ,
Woodlands Road, Bristol, BS8.1UG
****Sea Life Surveys, Dervaig, Isle of Mull, Argyll, PA75.6QL

INTRODUCTION Whale-watching is an expanding industry with new ventures starting all over the world. In addition to giving live whales a financial value and generating revenue and employment whale-watching often provides opportunities to study marine life, and cetaceans in particular, at sea.

Whale-watching operations can be the source of many types of data. It should certainly not be forgotten that the whale-watching operators themselves are a source of anecdotal information on whales. They probably have more direct experience of live whales than any other class of person in the modern world. Their observations are valuable and should at least be used to shape future research and formulate hypotheses to be tested.

Whale-watching can also provide platforms for biologists to get to sea to observe cetaceans at little or no cost. Various groups, particularly in North America, have successfully followed this approach. One of the best examples would be the Center for Coastal Studies on Cape Cod. Here, biologists have acted as guides on large commercial whale-watching boats for many years. They have collected photo-identification and behavioural data and have used this to investigate whale migration, determine life history parameters (such as rate of breeding and age at maturity), as well as document surface behaviour.

Whale-watching operations often benefit from involvement with research projects. Researchers make excellent guides and the link with research may make the activity more rewarding and attractive to the public

The nature of whale-watching varies greatly from operation to operation. However, from the point of view of providing opportunities for research, all, to a greater or lesser extent, share some common constraints. For example:

The operators must keep the paying public happy. They must find whales quickly, stay with them and get as close to them as allowable. "Fieldwork" can not be too onerous. Typically the research work is a secondary activity. There may only be a small scientific team which may also have to perform other duties. Data collection may be by non-scientists which can make it difficult to maintain a rigorous scientific approach. The team is likely to change over time.

Partly as a consequence of these constraints some types of data are easier to collect from whale-watching platforms than others. Information from individual animals, for example photographs for individual identification, records of surface behaviour and acoustic recordings, is usually possible to collect from whale-watching boats. Detailed studies of the use of small areas regularly visited by whale-watchers can be conducted.

Other forms of research are less easy to combine with whale-watching. Disruptive studies such as biopsy darting and lethal research are often incompatible with whale-watching for obvious reasons. In addition, whale-watching boats are usually not good platforms for

investigating cetacean distributions over an extended area, longterm tracking and studies at night, and collecting information on abundance.

The main problems are that operators are constrained to find, follow and approach whales and they usually work close to their home base. A first rule of survey design is that the movements of the platform should be independent of the subjects being surveyed. Whale-watching is an extreme case of the platform's movements being highly dependent of the subjects.

It is particularly frustrating that the collection of distributional and abundance data should be problematical because this is exactly the information which is needed for conservation and which, in most cases, is so completely lacking. Whale-watching represents an enormous amount of sea-based effort and accounts for a huge number of sightings and could make a very substantial contribution to answering these questions if such problems could be overcome.

AN EXAMPLE: SEA LIFE SURVEYS These considerations have been very influential in shaping the survey work attempted in recent years by Sea Life Surveys (SLS). SLS, started in 1990 by Richard Fairbairns, they are based on the Scottish island of Mull where they take paying members of the public out to see minke whales. From the outset, SLS were interested in conducting research to learn more about the lives of cetaceans and how they fitted into the local marine ecosystem. Their study site is an area of approximately 300 square miles, bounded by the islands of Coll, Mull and Rhum.

SLS's research platform is a 40ft motor vessel called *Alpha Beta*. A flying bridge provides a reasonably good vantage point for sighting cetaceans. Members of the public usually come on weeklong packages and are accommodated ashore, going to sea whenever the weather allows. The whale-watchers are encouraged to be involved in looking out for whales while searching, and in collecting various data from the whales once they have been spotted.

Research Some research activities are very compatible with whale-watching activities and the data are straightforward to collect and analyse.

For example: Surfacing-rate data are collected to investigate how surfacing behaviour changes with factors such as the behavioural activity of the animal, the state of the tide, the time of day, etc. Photographs are taken to identify individual animals. *Alpha Beta* has also been used as a platform for experiments with new techniques: for example, photographic range measuring and tracking methods, and underwater recording.

However, it was also important to address the more difficult problem of collecting abundance and distribution data from what promises to be a long-term project. In an effort to do this, a computer program called **LOGGER** was developed and written. **LOGGER**'s function is to facilitate the collection of opportunistic data to provide information on the distribution and relative abundance of cetaceans in the area.

LOGGER

1. Collects detailed data on environmental conditions, sightings effort and boat's activity.
2. Collects detailed data on each sighting and serves as an event recorder to log surfacing rate and surface behaviour directly to computer files.
3. Makes data collection easier by automating the input of data where possible and checking for errors in data entered by hand.
4. Helps to impose a pre-determined survey protocol on the boat.- specially important as the team changes over the years.
5. Yields computer database files, hopefully with fewer errors and ambiguities than conventional forms.

The program runs on the boat, collecting data in real time while it is at sea. Several different screens prompt for the collection of different sorts of information. Data on

environment are collected at regular intervals, sightings data including blow rates are collected during each sightings, and search effort is updated as and when it changes.

When recording effort, the number and location of observers is noted and, in addition, both the type of voyage being undertaken are recorded.

The categories used for voyage type are:

Hunch when the boat is going to find cetaceans in an area where there is some prior expectation of finding them.

Bumbling when the boat is looking for cetaceans with no *a priori* expectation of cetacean locations.

Passage - When the boat is transiting between two locations.

Survey - When the boat is keeping to a fixed pre-determined track.

Ferry Run - When the boat is acting as a ferry, which is another commercial activity of *Alpha Beta*.

Categories used for search status are:

Searching - Observers searching.

Directed Searching - when the boat has diverted to search in a smaller area based on knowledge or assumptions about cetacean distributions.

Making a Sighting - while a sighting is in progress.

Counting surfacing - while a sighting is in progress and surfacing rate data is being entered into the computer.

The number and location of observers are also recorded.

A companion program, SHOWDATA, plots tracks, sightings and effort.

PRELIMINARY RESULTS Logger provides good data on the process of sighting, revealing what factors affect ability to spot cetaceans and the range at which sightings are made.

Preliminary analysis shows that, as might be expected, number of observers, swell height and wave height and wind speed are all important factors.

For analysis of distribution and abundance, the area is divided into cells which are small enough so that it is not likely that the boat will direct effort within each cell. If searching effort is directed, then this must be recorded on LOGGER.

For each cell the number of sightings for each species is divided by effort to give an index which can be used to show cetacean distribution. The index of abundance in each cell is summed to give a measure of overall abundance.

Measures of effort can most simply be the miles steamed on effort in each cell. However, as we come to better understand the nature of the sightings process it should be possible to refine this, to allow for factors such as the number of observers and measures of sightings conditions. It may also be desirable to post-stratify by voyage type.

In the case of minke whales, surfacing data are collected for half an hour on each encounter. These data could be used to address the problem of defining group size. Thus, for minke whales, we could use either of three sightings indices for each cell: (1) No of sightings. (2) No of individuals. (3) No of surfacings observed.

CONCLUSION Whale-watching operations can provide very good opportunities for biologists to get out to sea and collect data. In many cases this may be the only way in which longterm studies can be undertaken. The data required to address some questions is

relatively straight forward to collect and analyse. Although sightings data are the most problematical to collect from whale-watching platforms, there are approaches which are worth pursuing.

Over the last decade or so a great deal of ingenuity has been applied by theoreticians to the problem of how to count cetaceans at sea. For some species at least, methods have been developed but the data required are very difficult and very expensive to obtain. Surveys can usually only be completed if they are necessary for a commercial activity, such as whaling, and cannot be repeated regularly. Perhaps it would be useful for the problem to be considered from a different perspective. If the same degree of effort was applied to the question of how to best assemble and analyse the data which we can afford to collect opportunistically, we might at least be able to derive reliable indices of abundance for many cetacean species, allowing population trends to be monitored.

**TOURISTS AND LOCALS; SEALS AND PORPOISES - FRIENDLY
INTERACTION AND MUTUAL ENDANGERING,
EXAMPLES FROM THE GERMAN ISLAND SYLT, NORTH SEA**

Rolf C. Schmidt* and Birgit Husel**

*Seevogelrettungs und Natuforschungsstation Sylt e. V., Bahnstraße 1,
25980 Tinum/Sylt

**Biologische Anstalt Helgoland, Littoralstation List, Sylt, Germany

The German island Sylt, located in the north-eastern part of the North Sea, has a famous tourist industry. Peoples' activities on the beaches are swimming, fishing, sailing, jet-skiing, para-gliding, surfing and driving by motorboats. They walk and rest in every area on the beaches. Local people engage in net-fishing with set nets both in the Wadden Sea and in the open North Sea. They also go fishing by boat with line and hook.

The area is inhabited by harbour seals (*Phoca vitulina*) (about 700 in 1993 counted on one small sandbank south of the island), grey seals (*Halichoerus grypus*,) and an unknown number of harbour porpoises (*Phocoena phocoena*) near the coastline. Both seal species and the harbour porpoises in particular swim and fish within 200 m from the beach. It is quite normal for harbour porpoises to come as close as 10 m or less to the beaches, and to swim very close to people who are swimming and playing in the water, even coming between tourists and sometimes touching them. Furthermore, they come close to small angling boats with stopped engines. Very often tourists believe them to be sharks because of the triangular dorsal fin.

Sea mammals are endangered by nets, angling lines and hooks and boat propellers but also by people throwing stones or angling equipment at them, or anglers on boats beating them with an oar. Live-stranded harbour porpoises have been hurt when people have tried to throw them back into the waves. People try to lift the porpoises or dolphins and hold them on their flippers, or drag them through the sand damaging their skin.

But also humans are endangered by sea mammals. Pups of harbour seals and grey seals regularly bite when people think they have lost their mother and want to touch them. One adult grey seal in summer 1993 jumped on angling boats to look for fish, frightening the people. Harbour porpoises make people fear for sharks, children swimming on an air mattress in summer 1993 having been frightened by two harbour porpoises surfacing less than one metre in front of them. It may also happen that people jump into cold water and strange currents when they see "dolphins". Or they might swim far away from the beach and try to touch the harbour porpoises. Especially when people try to take a baby porpoise in their arms, it may happen that the adult porpoise hurts this person when coming to the calf's assistance.

AN OVERVIEW OF WHALE-WATCHING IN THE CANARY ISLANDS

James R. Heimlich-Boran*, Sara L. Heimlich-Boran*, Roberto Montero**,
and Vidal Martin**

*DELPHIS, 7 Victoria St., Cambridge CB1 1JP, UK

**Grupo para el Estudio de los Cetaceos en el Archipelago Canario (GECAC),
Rambla General Franco, 63, S/C de Tenerife, Canary Islands

INTRODUCTION The occurrence of a resident population of short-finned pilot whales (*Globicephala macrorhynchus*) off the Southwest coast of Tenerife was not investigated until 1989. It has since been amply documented (Heimlich-Boran, 1993), as have the occurrence patterns of a diversity of other cetacean species utilising the area (Martin, *et al.*, 1992). Despite their abundance, no cetacean species had been important to the local human population prior to 1991 when the local pilot whales were discovered by the tourist industry. Regular whale-watching activity has since expanded at a rapid rate. In 1989, only ten boats operating sea-going excursions and none was fully dedicated to whale-watching. Currently, whale-watching activities are carried out by up to 25 medium-sized to large-sized commercial boats, carrying 20-150 passengers each; innumerable private sailing boats; and small motor boats which carry from 3 - 10 people.

Excursions are predominantly observational, but "Swim-With-The-Whales" trips are becoming increasingly popular. Official tourist boats require a variety of licences, but there is no permit specified for whale-watching. There are also untold numbers of "cowboy" operators in small boats who drive up to the beaches or the quays and offer quick trips out to the pilot whale area. There is no question that the local *Globicephala* population now contends with ever-increasing vessel traffic, both from the whale-watching industry as well as from commercial transport, such as regular and Jetfoil ferry services operating in the near vicinity of the whales.

The Canarian Government recently funded a study to determine the impact of increased boat traffic on the local *Globicephala* population, especially whale-watching vessels. This presentation summarises some of the results.

METHODS From July 1992 to September 1993, observations were conducted from a five metre inflatable boat with a 30 hp outboard motor off southwest Tenerife. Transects were conducted opportunistically with positions determined every 10 minutes using a global positioning system, with an accuracy of 15 metres.

In order to determine the effect of boats on the whales, we examined two types of data: respirations and group spacing. Samples were classified as "with boats" and "without boats" by recording when boats moved within a 40 m radius around the whales' position, including our own boat.

Respirations were recorded by timing intervals between the blows of recognisable adults in 30 min sample periods. A Log Survivor Function Test was used to define the difference between surface intervals and dive intervals (Fagen and Young, 1978). Four parameters were examined: blow intervals, "blow rate" (defined as the number of blows per minute), the number of blows per "surface period" (defined as one or more surface intervals preceded and followed by a dive), surface period duration, and dive interval.

Data on group spacing were collected by estimating the maximum and minimum distance between whales in a group every 30 sec during 30 min sample periods. Distances were estimated in whale body lengths and were only recorded when three or more whales were visible. An index of spacing was calculated as the ratio of minimum to maximum distance.

RESULTS Pilot whales were observed for 385 hrs. The frequency distribution of boat encounters (Fig. 1) shows that the pilot whales were subjected to greater attention bi-modally throughout the day due to some boats running two or more trips per day.

One hundred and fifteen 30-minute samples comprising 972 blow intervals were examined (489 without boats and 483 with boats). The Log Survivor Function Test determined 40 sec as the division between surface intervals and dive intervals.

The results of all analyses are presented in Table 1. The majority of the respiration data showed no significant data between observations with boats and those without boats. Only the Last Dive Before Surfacing showed significant differences: whales took prolonged final dives in response to boat traffic.

The spacing index for whale groups also showed significant differences, indicating that pilot whales moved into tighter spaced groups in the presence of boats.

CONCLUSIONS For the moment, the only conclusions that can be drawn are that the presence of boats in the vicinity of whales does not appear to significantly alter most respiration parameters, the exceptions being final dive times and group spacing. When boats are present, whales delay rising to the surface, and travel in more tightly compressed groups. This may be an indication of increased stress and may alter or restrict aspects of whale social behaviour, group feeding or defence. Most certainly, other parameters must be investigated, including whale orientation and behavioural changes.

To the observer watching cetaceans surrounded by heavy boat traffic, it cannot but appear as harassment, and that some sort of significant impact must be occurring. Yet results from this study show trends rather than statistically significant differences. This is a problem common to many vessel impact studies. It suggests we do not know sufficient about baseline parameters to measure subtle changes which indicate a departure from a norm, or that different parameters must be measured, or vessel disturbance has a cumulative effect which can only be measured over the long-term.

On several occasions, we have observed behavioural displays which indicate irritation bordering on clear aggression. This has occurred between whales and directed at our boat, and captured on film by the BBC. This could be their response to harassment. Coupled with the near-fatal interaction between a swimmer and a pilot whale in Hawaii, we must begin to accept that cetaceans have their own rules of protocol and we must assume they have a limit of tolerance.

Adequate legislation which will prevent harassment of whales in Tenerife clearly needs consideration, especially as they occur in such a concentrated area and the high percentage of small calves suggests it is of particular importance (Heimlich-Boran, 1993). Regulations are unlikely to happen without proof that harassment is occurring or that boat traffic has a deleterious effect.

REFERENCES

- Fagen, R. M. and Young, D. Y. 1978. Temporal patterns of behavior: durations, intervals, latencies, and sequences. Pp. 79-114. In *Quantitative Ethology*. (Ed. P. W. Colgan). John Wiley & Sons, NY.
- Heimlich-Boran, J. R. 1993. *Social Organisation of the Short-Finned Pilot Whale, *Globicephala macrorhynchus*, with Special Reference to the Comparative Social Ecology of Delphinids*. Ph.D. Thesis. University of Cambridge. 235pp.
- Martin, V., Montero, R., Heimlich-Boran, J. and Heimlich-Boran, S. 1992. Preliminary observations of the cetacean fauna of the Canary Islands. Pp. 61-65. In *European Research on Cetaceans - 5*. (Editor P.G.H. Evans). Proc. 5th Ann. ECS Conf., San Remo, Italy. European Cetacean Society, Cambridge.

Table 1. Summary of pilot whale/boat interaction data (mean \pm SD, n).

	Without Boats		With Boats		
Blow Interval (sec)	25.9 \pm 45.1	489	24.0 \pm 44.4	483	P > .05
Blow Rate (blows/min)	2.94 \pm 1.02	67	2.11 \pm 1.19	48	P > .05
Blows/Surfacing	9.95 \pm 7.70	67	8.58 \pm 7.96	48	P > .05
Surface Period (min)	2.25 \pm 1.64	67	1.89 \pm 1.63	48	P > .05
Dive Interval (min)	1.66 \pm 1.54	67	1.71 \pm 0.42	48	P > .05
Last Dive Before Surfacing	1.52 \pm 0.19	44	2.04 \pm 0.15	30	P < .05
Group Spacing Index	0.30 \pm 0.07	8	0.15 \pm 0.08	15	P < .05

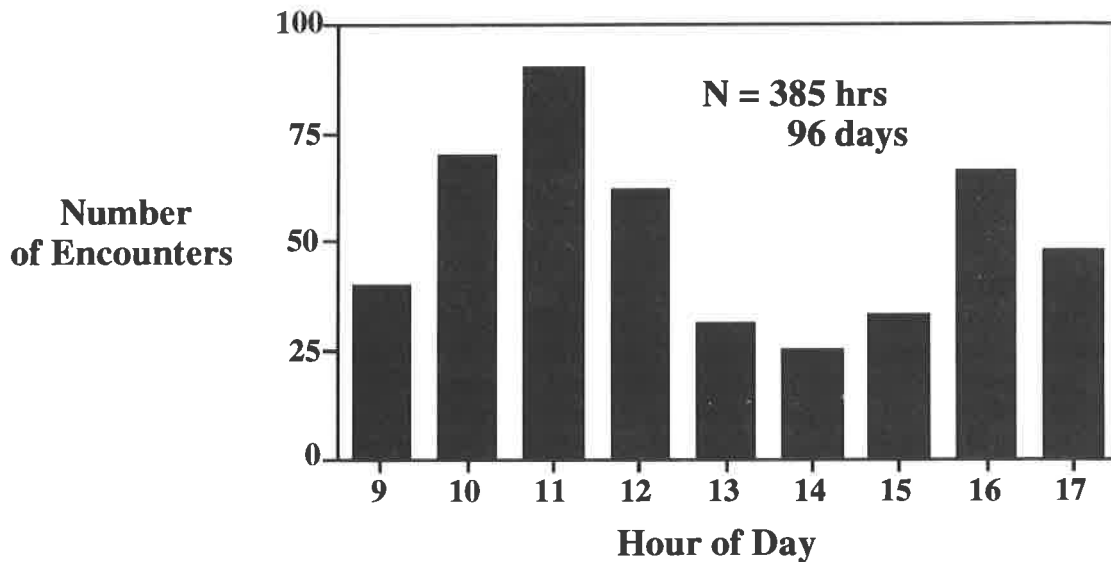

Fig.1. Plot of hourly pattern of pilot whale encounters with whale-watching boats.

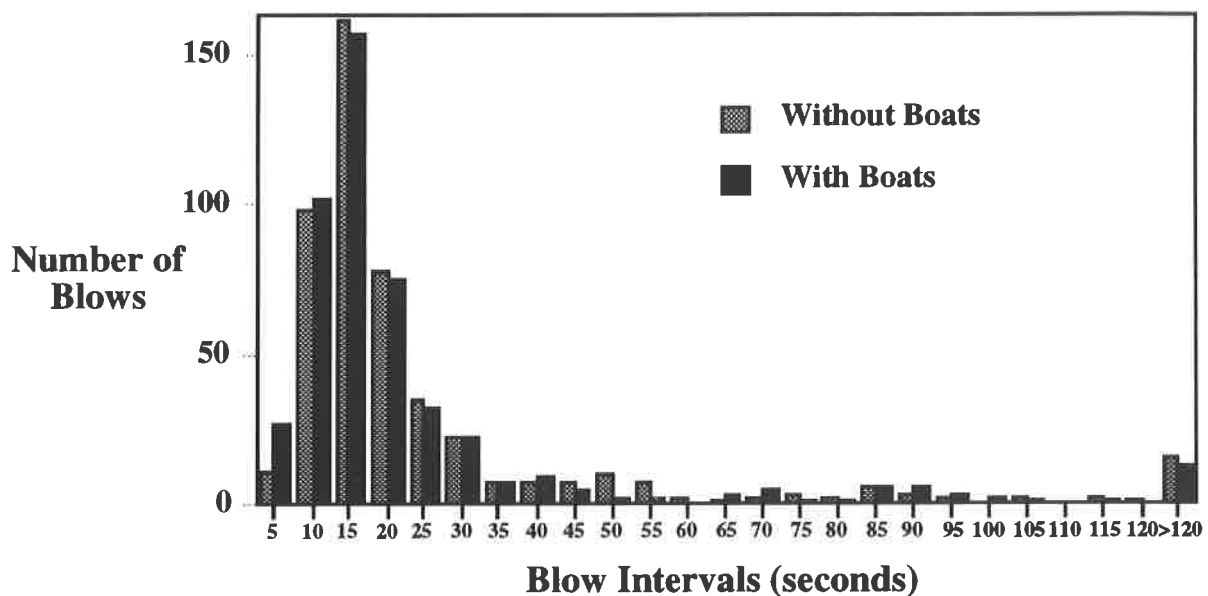

Fig. 2. Summary of all pilot whale respirations.

THE IWC'S RMP AND RWS - ACRONYMS, ANACHRONISMS OR A MANAGEMENT PROCEDURE FOR WHITE ELEPHANTS?

G. P. Donovan* and P. S. Hammond**

*International Whaling Commission, The Red House, Station Road,
Histon, Cambridge CB4 4NP, UK

**Sea Mammal Research Unit, N.E.R.C, High Cross,
Maddingley Road, Cambridge, CB3 0ET, UK

In 1982, The International Whaling Commission (IWC) agreed to implement a "pause" in commercial whaling from 1986. The rationale for this was that there was insufficient scientific knowledge to safely manage whale populations using the management procedure currently in place. Considerable effort was invested in developing a management procedure that relied only on the information that was likely to be obtainable (this eventually narrowed down to estimates of absolute abundance and information on catch numbers) and that took into account the inevitable uncertainty in any such information. Testing was carried out using extensive computer simulation trials for all assumptions, and all likely and even many unlikely scenarios.

Initially, work focused on "known" biological stocks. A major problem in management, is of course, determining stock identity; the procedure also had to be robust to errors in this. A complete procedure for calculating catch limits for baleen whales was defined (the *Revised Management Procedure* or *RMP*). This was "accepted" by the Commission in 1982 but further aspects (both scientific and non-scientific) were identified that required further work as part of a *Revised Management Scheme (RMS)*. The scientific aspects of this work were completed at the 1993 meeting of the Scientific Committee and unanimously recommended to the Commission. The culmination of eight year's work was the most rigorously tested management procedure for a natural resource yet developed. It sets a standard for the management of all marine resources.

LARGE-SCALE DRIFTNET FISHING: WHERE ARE WE AFTER THE UNITED NATIONS MORATORIUM

Robert L. Brownell, Jr.

Southwest Fisheries Science Center,
P.O. Box 271, La Jolla, California 92038, USA

During the 1980s, the expansion of large-scale pelagic driftnet fishing in most ocean basins was posing a threat to many species of living marine resources of the world's oceans. These concerns resulted in the United Nations passing various resolutions about driftnets. Resolution 46/215 established an indefinite global moratorium on the use of large-scale driftnets beyond the Exclusive Economic Zone (EEZ) of any country after 31 December 1992. In addition, the European Council of Fisheries Ministers passed a regulation (345/92) in February 1992 that all EC fishing vessels must comply with the UN driftnet moratorium, including prohibition against using driftnets longer than 2.5 kilometres after 31 December 1993.

Implementation of these moratoria must be closely monitored. No major violations were reported to the United Nations during 1993. However, numerous reports of unauthorised high sea driftnet fishing in the Mediterranean sea by Italian and other flag vessels continue to be made by the press and NGO's. In addition, the UN moratorium has caused some of the past high seas large-scale driftnet fisheries to move into the EEZ of some areas (i.e. Japan and Russia).

Marine mammal by-catches will continue to occur in these areas and need to be carefully monitored. Compliance with the moratorium and problems associated with large-scale driftnet fishing are reviewed.

ECOLOGICAL IMPACTS OF FISHING OPERATIONS: ASSESSMENT AND MITIGATION IN THE EASTERN PACIFIC TUNA-DOLPHIN INTERACTION

Martin A. Hall

Inter-American Tropical Tuna Commission,
8604 La Jolla Shores Dr., La Jolla, CA, 92037, USA

Marine mammal bycatches are one of the components of the larger issue of the bycatches in fisheries, which in turn is only one part of the even larger subject of ecological impacts of fisheries. The last includes, in addition to bycatches, impacts on the habitat (physical disturbances, pollution, etc.), "subsidies" to species (e.g. discards that can be utilised by some species), etc.

One of the activities that fisheries scientists will be performing in the coming years is assessment of those ecological impacts, to help the resource managers make better decisions concerning the choice of the best, or least harmful, ways of harvesting resources. Marine mammals, because of their low reproductive rates, and sometimes low abundances, are particularly vulnerable to the incidental mortality that a fishery can generate. But the same can be said of sea turtles, some species of sharks and rays, and even some other species of fish.

In the eastern Pacific Ocean, yellowfin tuna (*Thunnus albacares*), is the target of several fisheries, the largest of which, by far, is the purse-seine fishery. The fishermen detect and capture the tuna schools in three different ways:

- (1) They see a disturbance on the surface of the ocean caused by a school of tuna feeding or participating in some other activity, and enclose it in the net. Each fishing operation is called a set, and this type of set is called a "school set."
- (2) They encounter a floating object, usually a tree trunk or branch, but also wooden pallets, sheets of plywood, or practically any other kind of object, and they encircle it with the net early in the morning, knowing that tunas associate with floating objects during the night. This type of set is called a "log set."
- (3) They encounter a herd of dolphins, usually spotted dolphins (*Stenella attenuata*), spinner dolphins (*S. longirostris*), or common dolphins (*Delphinus delphis*), chase it, and encircle it, retaining the tunas and releasing the dolphins. This type of set is called a "dolphin set." In recent years, these sets enclose an average of 300 to 500 dolphins, and around 20 short tons of tunas. It is not known why dolphins associate with tunas, but the association is common in the eastern Pacific, and it has been observed in other oceans too (see list of references in Francis *et al.*, 1992).

These three types of sets produce different catches: sets on logs catch very small yellowfin (modal size around 2 kg.) and skipjack tuna (*Katsuwonus pelamis*); sets on free-swimming schools catch larger yellowfin (modal size about 10 kg), and sets on dolphins catch much larger fish (modal sizes about 25 and 60 kg). Most sets made in the eastern Pacific are dolphin sets, and about 55 to 80 % of the tonnage of yellowfin caught in recent years has been caught in dolphin sets.

When the fishery for dolphin-associated tunas was developed by the U.S. purse-seine fleet during the late 1950s, the mortality of dolphins in the fishery was very high, possibly in the order of several hundred thousand animals per year (Lo and Smith, 1986). The estimates are very poor, however, as a result of the paucity of data, lack of a sampling design, etc. During the 1960s the mortalities remained high, but the development of improved gear and

fishing techniques resulted in reduced mortality. Public awareness of the fact that mortalities of dolphins were occurring during purse-seine operations, produced legislation, beginning in 1972, which required that the mortality be reduced or eliminated.

The Inter-American Tropical Tuna Commission (IATTC), an intergovernmental research organisation, established by a treaty in the late 1940s, became involved in the tuna-dolphin problem in 1976. Its current members are Costa Rica, France, Japan, Nicaragua, Panama, the USA, Vanuatu, and Venezuela. Non-member nations which participate in the fishery, such as Colombia, Ecuador, Mexico, and Spain, also participate in its programs. The IATTC started an international observer program in the region in 1979, which produces data which are used to calculate annual estimates of mortality and relative abundance of the dolphins, and also information which is used for studies on the biology and ecology of dolphins and other species important to the ecology of the eastern Pacific Ocean. The data produced by the observers have also been used to identify the factors that affect mortality rates. These include environmental factors (currents, visibility), ecological/ethological factors (dolphin group size, catch of tuna, dolphin species, experience of the dolphins in being encircled by nets), geographical factors (areas), gear factors (availability of equipment to reduce entanglement or to rescue dolphins, condition of equipment, malfunctions), and crew factors (skill and motivation).

During the mid 1980s, there was a shift from fishing for tunas in free-swimming and log-associated schools to fishing for tunas in dolphin-associated schools. Also, there was an influx of fishermen with little or no experience in fishing for tunas associated with dolphins. Consequently, the mortalities of dolphins increased, reaching a peak of 133,000 animals in 1986. The IATTC increased its activities, conducting more seminars to facilitate the transfer of dolphin-saving techniques from the more-skilful to the less-skilful fishermen, more inspections of gear to ensure that the dolphin-saving components of the gear are functioning properly, and to increase its observer coverage of the fleet, eventually to 100 %.

The results of all these actions soon became apparent, and mortality has steadily declined. In 1993, incidental mortality of dolphins reached the lowest level in the history of the fishery, with 3,600 individuals (Lennert and Hall, 1995). Between 1986 and 1993, mortality had dropped by about 97%, and the fishery was still operating at a high level of effort in 1993. The average mortality of dolphins per set has gone from around 60 in the 1960s, to around 13 in 1986, and to 0.5 in 1993. As most of the reductions in mortality come from this source, the fishery has been able to survive. Some sacrifices had to be made in fishing efficiency, costs, etc., but these were preferable than the alternative of shutting down a major source of employment and income in the region. The relative mortality of dolphins (mortality/abundance) ranges for the different stocks between 0% and 0.16% (Table 1), while the minimum net recruitment rate is estimated to be about 2% (Smith, 1983). These estimates clearly indicate that those mortalities are sustainable, even if we multiply mortality by five and abundance by 0.5 as precautionary measures. Practically all the dolphin stocks involved in this fishery have been stable for a decade (Anganuzzi and Buckland, 1994).

One of the driving forces behind the reduction in mortality in recent years has been the participation of all nations fishing in the area in the International Dolphin Conservation Program, which was adopted in 1992 (Joseph, 1994). It set decreasing annual limits on dolphin mortality for 1993 (limit 19,500) to 1999 (limit <5,000). These limits were divided by the number of vessels participating in the program, and each vessel was assigned an individual limit for the year. If this limit is reached, the vessel must stop fishing on dolphins for the rest of the year. All vessels carry observers on all trips, and the raw data are inspected by an International Review Panel, composed of representatives of the nations, the industry, and environmental groups. The individual limits have provided an additional incentive for improvement, and in the first year the total mortality was only 20% of the allowed limit. Because of that performance, the limits for 1994 and 1995 were reduced from 15,500 and 12,000, respectively, to 9,300.

Dolphin mortality, or any other bycatch mortality, has two components, that can be viewed as the two levers that can be used to try to reduce it. As the total mortality is the product of the level of effort (e.g. in number of sets on dolphins in our case) and the average mortality per unit of effort, reducing either or both of these factors will result in a lower dolphin mortality. Fortunately, the mortalities per set on vessels with the most skilful, experienced, and conscientious fishermen were quite low, so getting the rest of the fishermen to use the techniques employed by the most skilful fishermen has proven to be a good way to reduce the overall mortality. A different solution to the problem, elimination of the fishery for dolphin-associated tunas, has been proposed by some environmental groups. Under this policy, canneries and other fish buyers would not buy tuna caught on trips during which dolphins were encircled. Laws in accordance with this solution have been adopted in the United States and the European community. In theory, this action would have forced the fishermen to cease fishing on dolphins and concentrate on alternative methods. This solution was not effective because of lack of public support in most of the nations with fleets participating in the fishery. The fishermen continued to fish for dolphin-associated fish and many canneries continued to buy their catches.

Elimination of fishing for dolphin-associated tunas would have two undesirable consequences:

(1) It would lead to poor utilisation of the tuna resources. Fishing on dolphins produces tuna of the optimum size to maximise yield per recruit, most of which are sexually mature, and few tuna are discarded because of small size or lack of demand for the species (less than 1% of the catch). Fishing "dolphin-safe" produces much smaller tuna, which reduces the yield per recruit significantly; most fish are sexually immature, and the discards are considerably greater (in school sets 4%, in log sets 29%).

(2) It has a large impact on the other components of the ecosystem. Even though the dolphin bycatch is greater (per ton of tuna produced, or per set) while fishing on dolphins, the bycatches of other species (sharks, rays, mahi mahi, wahoo, billfishes, sea turtles, etc.) are much less in dolphin sets than in "dolphin-safe" sets. Sets on logs have by far the largest bycatches. Table 2 shows the comparative "costs" of producing 1,000 short tons of yellowfin tuna with the different types of sets.

The "solution" to the dolphin mortality problem offered by the dolphin-safe approach is to drive the fishermen to other ways of harvesting the tuna resources, which do not harm dolphins, but that cause other ecological impacts, perhaps more significant from the ecosystem point of view. The scientific solution to the problem should consider not only the dolphins, but also the other components of the ecosystem.

REFERENCES

- Anganuzzi, A. A. and Buckland, S. 1994. Relative abundance of dolphins associated with tuna in the eastern Pacific Ocean: analysis of 1992 data. Rep. int. Whal. Commn, 44: 361-366.
- Francis, R. C., Awbrey, F. T., Goudey, C. L., Hall, M. A., King, D. M., Medina, H., Norris, K. S., Orbach, M. K., Payne, R., and Pikitch, E. 1992. *Dolphins and the Tuna Industry*. National Academy Press, Washington, D.C.: xii, 176 pp.
- Joseph, J. 1994. The tuna-dolphin controversy in the eastern Pacific Ocean: biological, economic, and political impacts. Ocean Development and International Law, 25: 1-30.
- Lennert, C. and Hall, M. A. 1995. Estimates of incidental mortality of dolphins in the eastern Pacific Ocean tuna fishery in 1993. Rep. int. Whal. Commn, 45: (submitted).
- Lo, N. C. H. and Smith, T. D. 1986. Incidental mortality of dolphins in the eastern tropical Pacific, 1959-1972. Fish. Bull. U.S., 84: 27-34.

Smith, T.D. 1983. Changes in the size of three dolphin (*Stenella* spp.) populations in the eastern tropical Pacific. Fish. Bull. U.S., 81: 1-13.

Wade, P.R. and Gerrodette, T. 1993. Estimates of cetacean abundance and distribution in the eastern tropical Pacific. Rep. int. Whal. Commn, 43: 477-493.

Table 1 Estimates of population abundance (pooled for 1986-1990, Wade and Gerrodette, 1993), of incidental mortality in 1993 and of relative mortality (with approximate 95% confidence interval) (Lennert and Hall, 1995).

Stock	Population abundance	Incidental mortality	Relative mortality	
			Estimate	95% CI
Northeastern spotted	730,900	1,139	0.16% (0.115,0.204)	
Western-southern spotted	1,298,400	757	0.06% (0.044,0.085)	
Eastern spinner	631,800	821	0.13% (0.077,0.205)	
Whitebelly spinner	1,019,300	412	0.04% (0.025,0.056)	
Northern common	476,300	81	0.02% (0.006,0.044)	
Central common	406,100	230	0.06% (0.030,0.111)	
Southern common	2,210,900	0		
Other dolphins	2,802,300	161	<0.01% (0.004,0.008)	
All	9,576,000	3,601	0.04% (0.033,0.042)	

Table 2: Bycatch per 1,000 short tons of yellowfin tuna loaded.

	School Sets (n = 2,317)	Log Sets (n = 702)	Dolphin Sets (n = 2,447)
Dolphins	<0.1	0.5	30.9
Small tunas	50,201.5	1,504,081.6	9,023.0
Mahi mahi	45.2	10,429.0	2.4
Sharks and rays	560.2	2,042.0	63.9
Wahoo	3.1	4,252.3	0.6
Rainbow runner	1.4	559.6	-
Other small fishes	80.1	3,858.5	21.1
Billfishes	23.7	113.7	4.1
Yellowtail	179.3	234.1	0.7
Sea turtles	3.6	6.6	0.6
Other large fishes	9.2	105.6	-
Trigger fishes	12.1	4,911.0	-
Discards of yellowfin tuna (short tons)	25.8	309.1	7.8

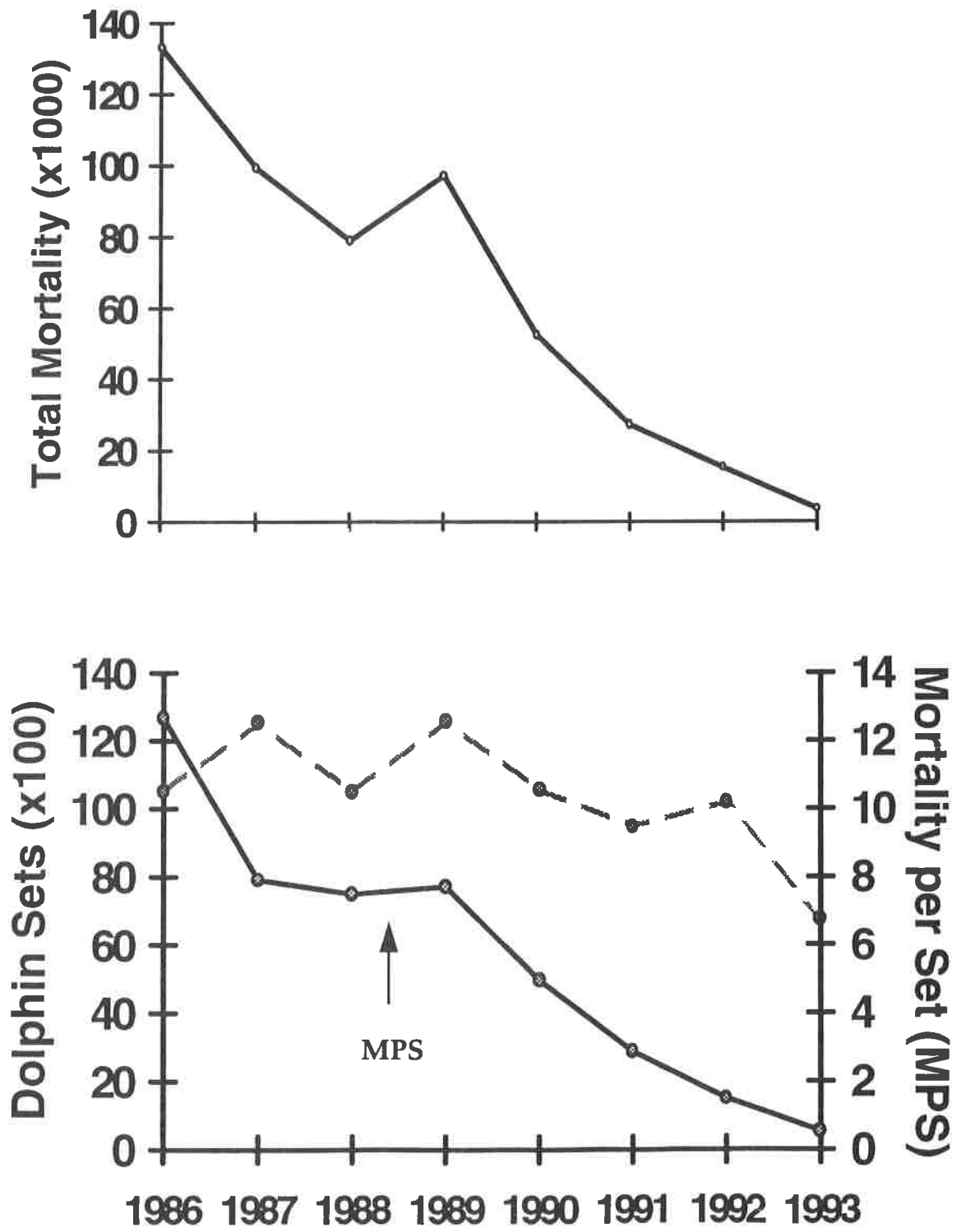

Fig. 1 Changes in Incidental Mortality between 1986 and 1993

A STUDY OF THE ECOLOGICAL IMPACT OF THE FRENCH TUNA DRIFTNET FISHERY IN THE NORTH-EAST ATLANTIC

Michel Goujon*, Loïc Antoine**, Anne Collet*** and Spyros Fifas**

*6 Cours Kennedy, F-35000 Rennes, France

**DRV-RH, Centre Ifremer de Brest, BP 70, F-29280 Plouzané, France

***CRMM Musée Océanographique, Port des Minimes,
F-17000 La Rochelle, France

This contribution presents several results of the French albacore tuna (*Thunnus alalunga*) drift gillnet fishery study. This study was conducted by the French institute Ifremer and the CRMM of La Rochelle at the request of the French Ministry of the seas, following a regulation of the European Council on drift gillnets. As recommended by the international study group in Brussels, the ecological risk linked to drift gillnetting was approached by the assessment of the incidental catches at the cetacean population level. Moreover, all by-catches have been quantified and the main species involved have been subject to a descriptive study.

The programme was divided in to two sections: the first one consisted of embarking on board French tuna driftnetters to identify and count the by-catches; the second one consisted of a dedicated sighting survey to estimate the delphinid populations in the fishing area, following line transect sampling methods (Buckland *et al.*, 1993).

During the 1992 and 1993 fishing campaigns, 18 observers embarked on board tuna driftnetters thus covering 27% of the overall fleet. About 85% of the catch is composed of the target species: albacore tuna, and the main by-catches include blue sharks, atlantic pomfrets, wreckfishes and swordfishes. Incidental catches represent mainly cetaceans and a few birds and turtles. The observed incidental catches of cetaceans are given in table 1.

Since effort in terms of kilometres of net was not available, and since landings by cruise were known for each vessel, by-catches for the total fleet have been extrapolated while using their ratio to the albacore catches. The total number of cetaceans incidentally caught per year was estimated to be 1,700 individuals.

The two main species involved are the striped dolphin (*Stenella coeruleoalba*), representing 69% and 64% respectively of the total incidental catch of cetaceans in 1992 and 1993, and the common dolphin (*Delphinus delphis*) representing in both years, 24% of the cetacean incidental catch.

The biological parameters collected on dolphins included length frequency data, age (from a tooth reading), and reproductive status (from gonadal histology). The results show that catches of calves of the year were predominant for both common and striped dolphins in 1992, whereas one year old young were predominant in the 1993 catches, suggesting the progression of a strong cohort in the catches for both species. Gonadal analysis suggests the age at first reproduction to be 9 to 10 years for common dolphins and 7 to 8 years for striped dolphins.

Population levels of both species were estimated from the observer data collected from the sighting survey and analysed with the computer program DISTANCE V.2.0 (Laake *et al.*, 1993), assuming that the population is entirely confined to the sampled area. In fact, the sampled area covers an unknown fraction of the complete distribution of the two species. Mean population sizes of common and striped dolphin were estimated respectively as 61,888 (SE: 17,945) and 73,843 (SE: 27,526) individuals.

As recommended by the Brussels study group, the estimates of the total incidental catch for these cetaceans were compared with the population size estimates, giving an average ratio of 0.7% and 1.6% respectively for common and striped dolphins. A Leslie matrix based model was then built to simulate the change in the annual population increase rate due to the additional mortality caused by the fishing action. This model uses as parameters, age at first reproduction, calving interval and annual rate of survival of calf and non-calf individuals. Under the initial population balance assumption, a fishing mortality of 1.5% and 3% (95% upper confidence limits of the average ratios) respectively for common and striped dolphins would lead to an annual decrease rate of 1% and 0.5% respectively.

The results of both the short term comparison and the medium term simulation indicated that it was unlikely that the actual mortality would jeopardise the survival and the presence of these species in the North-east Atlantic Ocean, but that the level of that effort should be controlled to avoid reaching significant incidental mortalities in terms of impact at the population level.

REFERENCES

- Buckland, S.T., Anderson, D.R., Burnham, K.P. and Laake J.L. 1993. *Distance sampling. Estimating abundance of biological populations*. Chapman and Hall, London. 446pp.
- Laake, J.L., Buckland, S.T., Anderson, D.R. and Burnham, K.P. 1993. *DISTANCE User's guide V2.0*. Colorado Cooperative Fish and Wildlife Research Unit, Colorado State University, Fort Collins, CO. 72 pp.

Table 1. Cetacean incidental catches in number of individuals by the French albacores tuna drift gillnet fishery.

Species	Number of observed catches in 1992	Number of observed catches in 1993
Common dolphin (<i>Delphinus delphis</i>)	114 (4)	90 (2)
Striped dolphin (<i>Stenella coeruleoalba</i>)	330 (7)	243 (3)
Bottlenose dolphin (<i>Tursiops truncatus</i>)	10	8 (1)
Short-finned Pilot whale (<i>Globicephala melas</i>)	13	16 (2)
Risso's dolphin (<i>Grampus griseus</i>)	0	7
Sperm whale (<i>Physeter macrocephalus</i>)	1	6 (5)
Pygmy sperm whale (<i>Kogia breviceps</i>)	0	1
Fin whale (<i>Balaenoptera physalus</i>)	2	0
Minke whale (<i>B. acutorostrata</i>)	0	1
unidentified cetacean	5 ¹ (2)	5
Total	475 (13)	377 (13)

¹ including apparently *Mesoplodon sp.*
In brackets: number of individuals released alive.

INTERACTIONS OF THE GERMAN FISHERIES WITH SMALL CETACEANS IN THE NORTH SEA : A FIRST APPROACH

Paula Moreno

WWF-Wattenmeer & Nordseeschutz,
Am Guethpol 11, D-28757 Bremen, Germany

INTRODUCTION Small cetaceans in the southern North Sea have suffered a decline, the most evident being the changes in harbour porpoise (*Phocoena phocoena*) populations (Evans, 1990). Fisheries are appointed as one of the major causes for the decline, directly or by depleting their food sources (Reijnders, 1992).

The stranding survey in Germany collects about 80 harbour porpoises every year, (Bohlken and Benke, 1992). However, the assessment of interactions with fisheries is limited by the advanced decomposition of carcasses, which prevents the recognition of netmarks.

The main aim of this study is to shed some light on the extent of the bycatch of small cetaceans caused by the German fisheries from the North Sea.

METHODS An interview survey of 44 fishermen was carried out personally from October to December 1992 along the German North Sea coasts.

The occurrence of a bycatch (number of vessels with bycatch/total number of vessels) and an index of bycatch (number bycatch/vessel/year) was estimated for the main fishing gear (bottom and pelagic trawls), as well as for the main fishing areas, namely the south and east coasts of the German Bight (GB) and the remaining areas of the North Sea (NS).

The bycatch effort was estimated for the fleet from 1989 using indices of fishing areas and fishing gear. Intervals resulted from assuming, in the case of fishing areas, that only the deep sea fleet belong to the NS (lower limit), while the upper limit results from including both deep sea vessels and cutters in this category. In terms of fishing gear, the lower limit assumes that all deep sea vessels operate with pelagic nets, whereas for the upper limit only factory ships are included in this category.

RESULTS Nearly half of the fishermen (43%) interviewed reported bycatches, but most of the bycatches (86%) were said to be rotten (Figure 1).

The bycatch index from bottom trawlers (0.197) exceeds that from pelagic trawlers (0.013) by more than an order of magnitude (Figure 2).

Regarding bycatch levels in different fishing areas, it is more intensive in the NS than in the GB (Figure 3), with bycatches on the east coast (0.06) largely exceeding the index of catches from the south coast (0.01) (Figure 4).

Estimating the bycatch effort by fishing area results in 30-183.5 bycatches/year.

In terms of fishing gear, the bycatch effort ranges from 105.7-112.1 bycatches/year.

Considering the structure of the German fisheries, the former estimate seems more realistic.

DISCUSSION The German fisheries in the North Sea do not seem to have high rates of bycatch, which is not surprising since bottom trawls are the main fishing gear used. The coastal fisheries operate with beam-trawls for flatfish or shrimps.

The increase in bycatch from the south of the GB to the northern NS, probably reflects the distribution of small cetaceans.

Most of the bycatch animals are rotten and might result from other fisheries, as was suggested by fishermen, who blamed the industrial fisheries ("Gammelfischerei") and "wreck-fisheries".

In spite of the small catches estimated for the German fisheries in this area, no conclusions can be drawn about their impact on the population(s) of harbour porpoises due to the lack of data (e.g. abundance). Nevertheless, it should be reminded that the northern part of the east coast is likely to play an important role as a breeding ground.

RECOMMENDATIONS Fisheries such as the pelagic trawlers for herring and mackerel operating off Norway and British coasts, as well as the wreck and industrial fisheries deserve further investigation.

Most of the fish and fish products consumed in Germany are imported and often originate from fisheries that threaten small cetaceans (for example, Germany is one of the main importers of fish meal from countries such as Peru). Therefore, imports should be traced and measures taken to discourage the catches of small cetaceans.

REFERENCES

Evans, P.G.H. 1990. Cetaceans. Pp. 89-101. In *North Sea Report*. The Marine Forum for Environmental Issues, London.

Bohlken, H. and Benke, H. 1992. Untersuchungen über Bestand, Gesundheitszustand und Wanderungen der Kleinwalpopulationen (Cetacea) in deutschen Gewässern. Intern.Rep. für Haustierkunde, Kiel, Germany.

Reijnders, P.H.J. 1992. Harbour porpoise *Phocoena phocoena* in the North Sea: numerical responses to changes in environmental conditions. *Neth. J. Aquat. Ecol.*, 26 (1): 75-85.

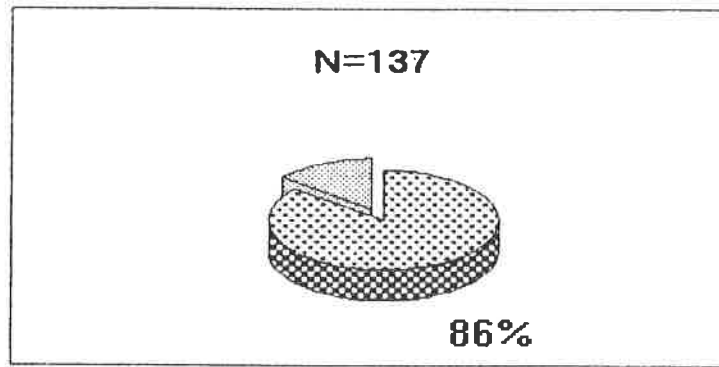

Fig. 1 Percentage of rotten bycatches (dotted) from the total bycatches reported

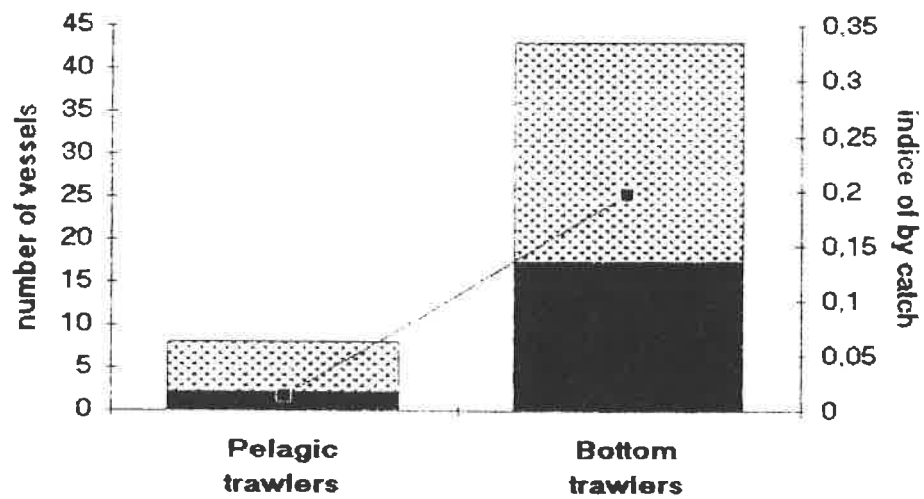

Fig. 2 Number of pelagic and bottom trawlers with bycatch (solid) from the total of vessels assessed, and bycatch index (squares)

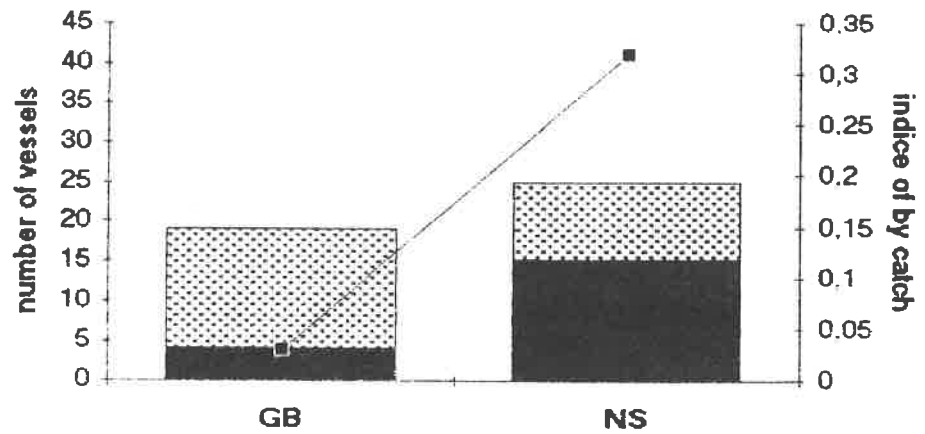

Fig. 3 Number of vessels with bycatch (solid) fishing in the German Bight (GB) and North Sea (NS) from the total of vessels assessed and bycatch index (squares)

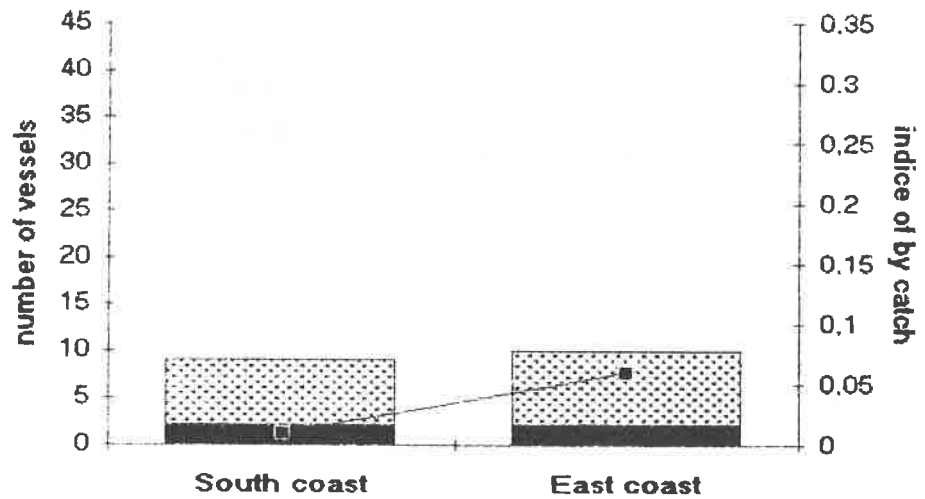

Fig. 4 Number of vessels with bycatch (solid) fishing in the South and East coasts from the GB and bycatch index (squares)

BY-CATCHES - FLEETING NETMARKS ON SMALL CETACEANS

Rolf C. Schmidt* and Birgit Husel**

*Seevogelrettungs und Natuforschungsstation Sylt e. V., Bahnstraße 1,
25980 Tinum/Sylt

**Biologische Anstalt Helgoland, Littoralstation List, Sylt, Germany

A great number of whales, dolphins and porpoises are killed in fishing gear every year. Often very prominent netmarks are clearly visible on the skin of the cetacean. Most known netmarks are persistent, but on the German island Sylt the authors found marks on harbour porpoise skins which faded away after an hour or two.

Photographs and a video are presented to illustrate the observations.

The question of why dolphins and porpoises get entangled in nets of such a material that should be recognised by the animals' eye or sonar system, is also discussed.

BOTTOM SET GILL-NETS: PROBLEMS OF PERCEPTION FOR DOLPHINS AND PORPOISES.

A. David Goodson

Signal Processing Research Group - Bioacoustics & Sonar,
Electronic Engineering Department,
Loughborough University of Technology, Loughborough, LE11 3TU, UK.

INTRODUCTION Around the world, 'bottom set' or 'sink' gill-nets are set in a variety of water depths to catch bottom dwelling demersal fish species. Such passive fishing nets, even those set at depths exceeding 100m, appear to pose problems of perception for small cetaceans since many are accidentally entangled. In particular, the harbour porpoise (*Phocoena phocoena*) is a common by-catch victim in certain commercial fisheries. The impact of sink-net fisheries on the populations of these animals is now of great concern, especially along the N.E. coast of America. The problem also exists in European waters as current studies are showing. The fact that an air breathing animal can be caught at such depths is indicative that they are actively foraging for food at the time, a fact confirmed by the stomach contents of by-caught animals. Since foraging behaviour presumes a high state of alertness and the use of the animal's active echolocation sense, this failure to avoid a static fishing net obstruction on the seabed is primarily one of sonar perception. Whilst evidence that the porpoise is attracted by prey already enmeshed in nets is largely negative, some recent data from the U.S.A. suggests that the fishing net may act as an aggregating device for the porpoise since undigested hag fish (*Myxine glutinosa*) (a known scavenger of enmeshed fish in deep water) have been found in the stomach contents of bycatch victims.

This paper considers some behaviour-related and physical phenomena which bottom foraging cetaceans face when interacting with a 'bottom set' or 'sink gill-net' structure. Techniques which enhance the acoustic detectability of the gill-net mesh (webbing) are believed to offer the best method of mitigating this mortality. However, in order to understand the animal's underwater behaviour, it is clear that new methods of tracking cetaceans underwater near fishing nets are needed. Otherwise the effectiveness of such devices can only be judged from body count statistics.

ACOUSTIC DETECTION OF BOTTOM SET GILL-NETS Methods of rigging and setting 'bottom set', or 'sink' gill-nets vary with different fisheries, but in general these nets comprise a buoyant float line which is intended to lift a panel of gill-net mesh (mono- or multi-filament) into a vertical plane above a weighted 'headline' lying on the seabed. The net sections, usually 50m long, are tied together by short rope 'bridles' to make up much longer 'strings' or 'sets' (typically from 200m to 1km overall). The completed string is anchored to the seabed at both ends and may be set across, or more usually with, the direction of the local tidal stream. Sink gill-nets are set at depths which may exceed 150m and are 'soaked' for different periods depending on the target species of fish sought and on weather conditions which may delay hauling. Soak periods ranging from 12 to 36 hours are common. For a small cetacean, these structures comprise a 'difficult' sonar target (Goodson & Datta, 1992) and also, even in shallow water and strong sunlight, the mesh may be quite invisible to the eye in dappled light filtering from the surface. Although the headline and leadline may be expected to be detected relatively easily by sonar, the leadline on a soft seabed tends to become buried and may therefore disappear as an acoustic target. Likewise, when set across stony ground, the acoustic echo 'clutter' will mask the (very directional) echo that may return from the leadline. The headline, when fitted with closely spaced discrete spherical or elliptical floats (when these exceed several cm diameter) can provide a very detectable structure for the animal's sonar. However, this presumes that the animal orientates itself so that its directional sonar sense detects this headline structure as a barrier. A bottlenose dolphin operates a (potentially) high power sonar (max 227 dB re 1Pa - Au, 1980) and has the capability to detect such a sub-surface structure at ranges of 50 m or

greater, but since the fishing net can only reflect the higher frequencies within the animal's wideband sonar pulse, the beamwidth within which detection can occur is limited to about 10°. By contrast, the harbour porpoise has a much lower power sonar, operating some 50 db or more below that of the bottlenose dolphin (Akamatsu, 1992; Sturtivant *et al.*, this volume), and is believed to project a much wider beamwidth (possibly 18° in both azimuth and elevation). As a result, its detection range for the headline component of a fishing net is very much shorter, and observations by Hatakeyama and Soeda (1993) suggest a 9 m maximum range under ideal conditions.

This raises an interesting geometry problem with bottom set gill-nets. If a porpoise is foraging on the seabed and directing its attention to prey just above the bottom, and if the animal's sonar beamwidth is 18° wide in the vertical plane, then at distances less than 9m, targets situated more than 3m above the bottom may never be detected! (Figure 1). Many European bottom set nets are rigged for heights between 2.5m and 2.8m. However, net heights exceeding 4m are in common use elsewhere. Hatakeyama's observations also confirmed that mono-filament mesh zone is quite invisible to the harbour porpoise sonar at ranges greater than 2m, and when distracted by prey the recognition of the net as a hazard may not occur. The effect of tidal current direction changes should also be considered since, if an animal has learned to forage along the line of a bottom set net, the position of this structure between the anchors may move very significantly when the tide direction alters. It is quite conceivable that the centre of a long set net may 'bow' some 100 metres in the opposite direction after the tide turns. Worse still, the mesh zone, which tends to 'bag' to one side with the water flow, will now form an obstruction to passage along the opposite side and an animal which has become accustomed to sensing the net's position by the floatline or leadline echoes may well collide with the mesh in this changed configuration.

Clearly the mesh zone must be made much more detectable. Very recent tests with two (stranded and successfully rehabilitated) juvenile harbour porpoises at Harderwijk in Holland have shown that this problem of detecting and correctly classifying the mesh zone as a hazard is at the root of the problem since, even after several enmeshing encounters, these animals would still get themselves caught, particularly if the position of the mesh curtain moved (Kastelein *et al.*, 1994). This unique study showed that the porpoise's instinctive reaction to contact with the mesh is an attempt to make a sharp 'U' turn which unfortunately ensures that they became totally enmeshed (these tests were carried out with elaborate precautions to ensure that the animals were not at risk of injury!).

PASSIVE REFLECTORS The harbour porpoises at Harderwijk were also shown a passive acoustic reflector barrier which in this case comprised a floating headline and a leadline supporting a single line of -35dB (ref. a 2m radius sphere) TS reflectors, deployed midwater at 1.2m intervals on thin vertical strings (Figure 2). This 'barrier' offered no physical obstruction to the animals which could easily have swum through it at any point without contact. The porpoises were contained by this structure into one half of their pool and refused to cross this 'barrier' even when chasing live fish which passed through! The structure was also pulled to one end and contained an animal trapped against the wall for a significant period before it eventually 'escaped' through it. Even after this experience, the structure continued to function as a deterrent barrier with each reflector attracting echolocation attention as the animal approached. When the leadline was lifted to the surface, the porpoises passed freely underneath the floating reflectors, headline, and leadline without hesitation.

GILL-NET TRIALS The addition of passive reflectors has also been shown to be an effective deterrent to wild bottlenose dolphins in the Moray Firth, Scotland, where a three year series of tests with simulated nets has shown long range detection and induced consistent avoidance behaviour (Mayo and Goodson, 1992; Klinowska *et al.*, 1992; Goodson and Mayo, 1994). Initial small scale tests at sea have pointed to some net handling problems caused by the presence of the reflectors, and the method of attachment is being improved. Side scan sonar trials on reflector modified nets, deployed at the surface (Goodson, 1992) and on the bottom (Goodson, 1994), confirm that the addition of passive

reflectors makes the gill-net mesh zone very detectable. It is hoped that the first tests of this deterrent technique in a commercial fishery will start during 1994.

CONCLUSIONS Very little is known about the foraging strategies employed by harbour porpoises and by most of the pelagic dolphins. New study methods, especially underwater acoustic tracking techniques and ways of recording the sonar activity of small cetaceans foraging near fishing gear, are needed in order to examine the underwater behaviour of small cetaceans offshore, in relatively deep water and close to fishing nets. Risks to dolphins from bottom-set or sink gill-net fishing operations are believed to be significantly less than for harbour porpoises. The converse appears to be true for midwater and near surface fishing operations. Time-depth recorders temporarily attached to harbour porpoises rescued from Canadian herring weirs have shown that these animals may forage in water depths occasionally exceeding 140m. Compared with dolphins, harbour porpoises are difficult to track visually at the surface and as their sonar signals are significantly different (narrow band), the use of carefully matched acoustic detection techniques may give more useful indication of their presence. However, as their sonar signals are emitted at very low Source Levels, practical detection ranges are predictably much shorter than for dolphins. The bycatch data resulting from the on-board observer programmes underway in several commercial fisheries around the world, suggest that the problems and sensory abilities of the harbour porpoise are in need of urgent study.

ACKNOWLEDGEMENTS Special thanks are due to Ron Kastelein, Saskia Nieuwstraten, Carolien Staal and colleagues at the rehabilitation centre at the Harderwijk Zeedierenpark in the Netherlands and to their two enthusiastic research assistants 'Marco' and 'Frank' (the rehabilitated harbour porpoises). The assistance of the Seafish Industry Authority (Hull) and the financial support of the European Commission DGXIV and the UK Ministry for Agriculture, Fisheries and Food is gratefully acknowledged.

REFERENCES

- Au, W. W. L. 1980. Echolocation signals of the Atlantic bottlenose dolphin (*Tursiops truncatus*) in open waters. In *Animal Sonar Systems* (Eds. R. Busnel and J. F. Fish). Plenum Press, New York.
- Akamatsu, T. *et al.* 1992. Process of Harbour porpoises' entanglement in the gill net. Technical Report of N.R.I.F.E.: 25-36.
- Goodson A. D and Datta S, 1992 Acoustic Detection of gill-nets: The dolphin's perspective. *Acoustic Letters* V16(6): 129-133.
- Goodson A. D. 1992. Enhancing gill net acoustic detectability: Initials handling trials at sea. In *Initial trials to increase Acoustic Detectability of Drift Nets used in the Albacore Tuna Fishery*. (Ed. J. Swarbrick). Report No.408, Seafish Industry Authority, Hull.
- Goodson A. D. 1994. Sidescan Sonar Trial (Appendix I). In *Investigation of the selectivity of static nets, and an assessment of bycatch, effort and discards - ICES areas VIIe & VIIf*. J. Swarbrick (ed). Consultancy report No.66, Seafish Industry Authority, Hull, UK.
- Goodson, A. D. and Mayo, R. H. 1994. Interactions between free-ranging dolphins *Tursiops truncatus*, and passive acoustic gill-net deterrents. Harderwijk Marine Mammal Sensory Symposium, April 1994. In *Sensory systems of aquatic mammals*. (Eds. R.A. Kastelein. J.A. Thomas and P.E. Nachtigall). De Spils, Weoden, NL.(in press).
- Hatakeyama, Y. and Soeda, H. 1990. Studies on echolocation of porpoises taken in salmon gillnet fisheries. Pp. 269-281. In *Sensory Abilities of Cetaceans, Laboratory and Field Evidence*.
- Kastelein, R., de Haan, D. and Verboom, W. 1994. Causes of Harbour porpoise, *Phocoena phocoena*, entanglement in fishing nets. Harderwijk Marine Mammal Sensory Symposium, April 1994. In *Sensory systems of aquatic mammals*. (Eds. R.A. Kastelein. J.A. Thomas and P.E. Nachtigall). De Spils, Weoden, NL.(in press).

Klinowska, M, Goodson, A. D., Mayo, R. H. and Bloom, P. 1992. Progress in the development of efficient warning devices to prevent the entrapment of cetaceans (dolphins, porpoises and whales) in fishing nets. I.C.E.S Conference, Rostock, Germany. Doc. No. C.M.1992/N:17-Ref.B.

Mayo, R. H. and Goodson, A. D. 1992. Interactions between wild dolphins and a moored barrier; Initial results from the 1991 Moray Firth Trial. Pp. 184-189. In *European Research on Cetaceans - 6* (Ed. P.G.H. Evans). Proc. 6th Ann. Conf. ECS, 20-22 February 1992, San Remo, Italy. European Cetacean Society, Cambridge, UK.

Mayo, R. H. and Goodson, A. D. 1993. Landbased tracking of cetaceans - a practical guide to the use of surveying instruments. Pp. 263-268 In *European Research on Cetaceans - 7*: (Ed. P.G.H. Evans). Proc. 7th Ann. Conf. ECS, 18-21 February 1992, Inverness Scotland. European Cetacean Society, Cambridge, UK.

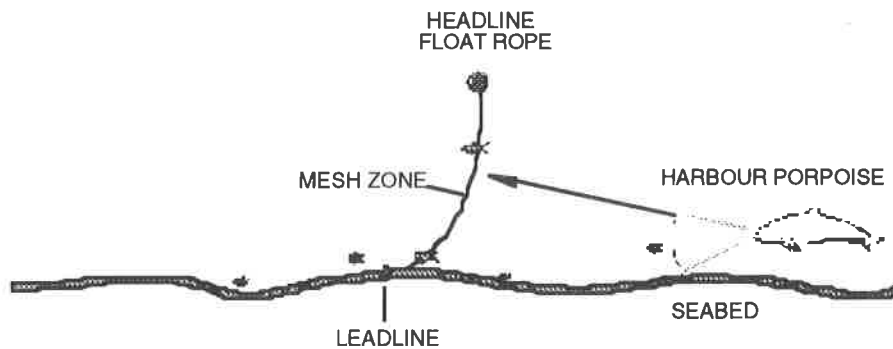

Fig. 1 Failure to detect the headrope may occur when this is outside the vertical beamwidth of the sonar at the maximum detection range

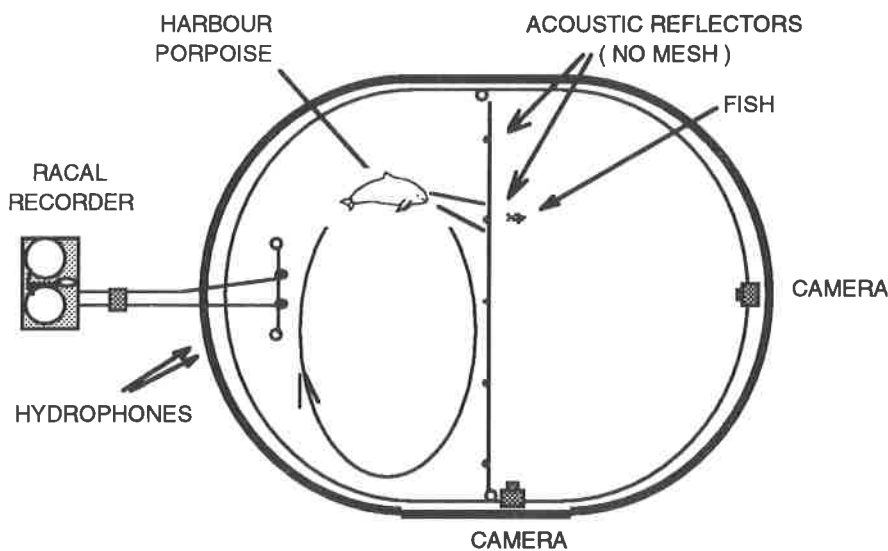

Fig. 2 A single line of passive acoustic reflectors at 1.2 m spacing deterred the porpoise from passing through 'barrier', even when chasing a fish

INCIDENTAL KILLING OF BLACK SEA DOLPHINS OFF THE CRIMEA AND KRASNODAR TERRITORY COASTS: ANALYSIS OF OFFICIAL DATA AND OUTLOOK

Andrey Artov*, Vadim Pavlov* and Tamara Zhuravleva**

*BREMA Laboratory, Simferopol, Crimea 333720, Ukraine

**Crimea Fish Protection Service, Kerch, Crimea 334500, Ukraine

INTRODUCTION Fishery-cetacean conflicts occur everywhere on the globe and most of these result in the death of cetaceans (EIA, 1991). This especially concerns net fisheries. Fishing gear used in the Black Sea may also be dangerous for cetaceans. But data on the impact of fisheries on Black Sea dolphins has never been published. This paper attempts to throw some light on the problem.

MATERIALS AND METHODS In 1993, we made a careful study of the reports of the Crimea Fish Protection Service (CFPS) (Reports of the Crimea Fish Protection Service, 1977-1990). We have analysed all available data from 1968 to 1990 on bycatches of Black Sea dolphins in fishing gear.

RESULTS The total number of bycaught dolphins amounted to 1,827. The number of bycatches fluctuated from two to 206 per year, and the majority of animals caught were harbour porpoises (Fig. 1). Harbour porpoises (*Phocoena phocoena*) represented 78.4% of the total number, common dolphins (*Delphinus delphis*) 16.1% , and bottlenose dolphins (*Tursiops truncatus*) 5.5%. The most dangerous for these animals were bottom gillnets for plaice and bottom gillnets for dogfish (Fig. 2). These nets trapped 98.1% of the animals and, of these, 99.8% died. We have found only isolated cases of bycatches in picketed nets and illegally set bottom gillnets for sturgeon, called ahans.

DISCUSSION Dolphin bycatches are recorded at the same time as the control of nets by fish inspectors who are responsible for the observance of fishing regulations. Controls on plaice fishing are usually put into effect in each case.

The data collected suggest that entanglement in bottom gillnets is the main cause of dolphin mortality in fishing gear. In coastal waters off Crimea, those nets used for plaice (*Scophthalmus maeoticus*) and dogfish (*Squalus acanthias*) resulted in catches. However, the recording of bycatches in dogfish gillnets was carried out only in isolated cases. Because of this, the number of bycatches for all dogfish gillnets used was not calculated. Thus a large proportion of the cetaceans bycaught in these nets has been left out of the calculations.

Besides special bottom gillnets (ahans) which are used wide for illegal catching of sturgeon (*Acipenser giildenstadtii*) The features of these nets are similar to those of plaice and dogfish nets (Fig. 2). The nets can also be very dangerous for dolphins. Sturgeon poaching is a large fishery that is omitted from the records kept by the CFPS. For this reason, it is not possible to estimate the impact of this fishery on dolphins.

Data on trawl bycatches were not recorded, although this fishery constitutes a very large part of fisheries off Crimea.

In many cases, even legal fishermen are reluctant to release information on dolphin bycatches. This also decreases the number of reliable data available.

CONCLUSIONS It may be concluded that the official estimates were lower than the actual number of animals bycaught. All these defects of the bycatch recording scheme should be taken into account in any calculation of the actual number dying from this cause.

The system should be a starting-point for the establishment of preventive measures which will decrease the accidental killing of dolphins.

ACKNOWLEDGEMENTS We thank our collaborators in the Crimea Fish Protection Service for all their help.

REFERENCES

EIA (Environmental Investigation Agency). 1991. *The Global War Against Small Cetaceans*. A second report by the Environmental Investigation Agency. 63pp.

Reports of the Crimea Fish Protection Service 1977-1990. Official documents.

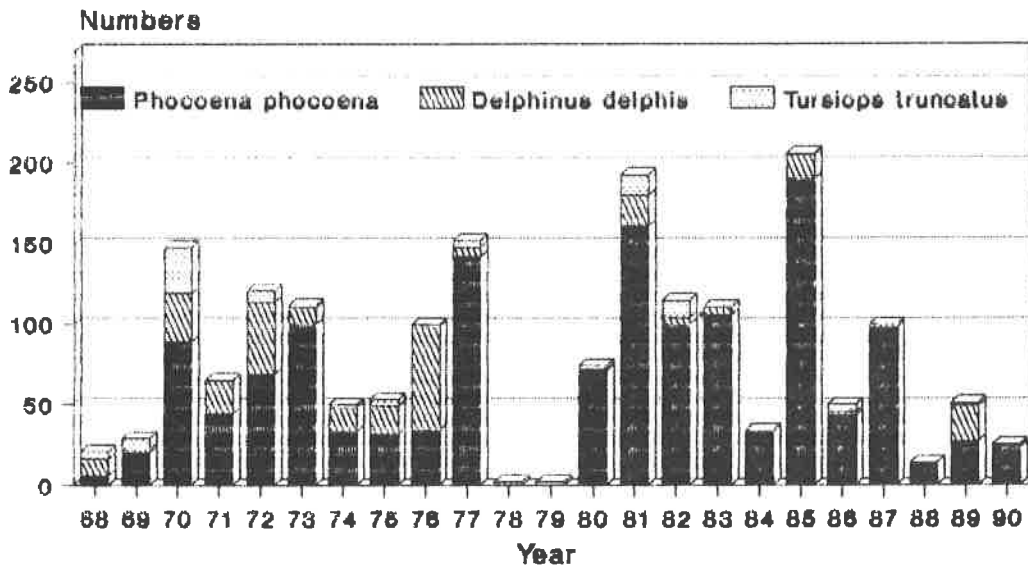

Fig. 1 Bycatches of the three species of small cetaceans occurring in the Black Sea. Data from Crimea Fish Protection Service, 1968 to 1990 (numbers of *P. phocoena* are not available from 1978 or 1979; and of *T. truncatus* from 1978)

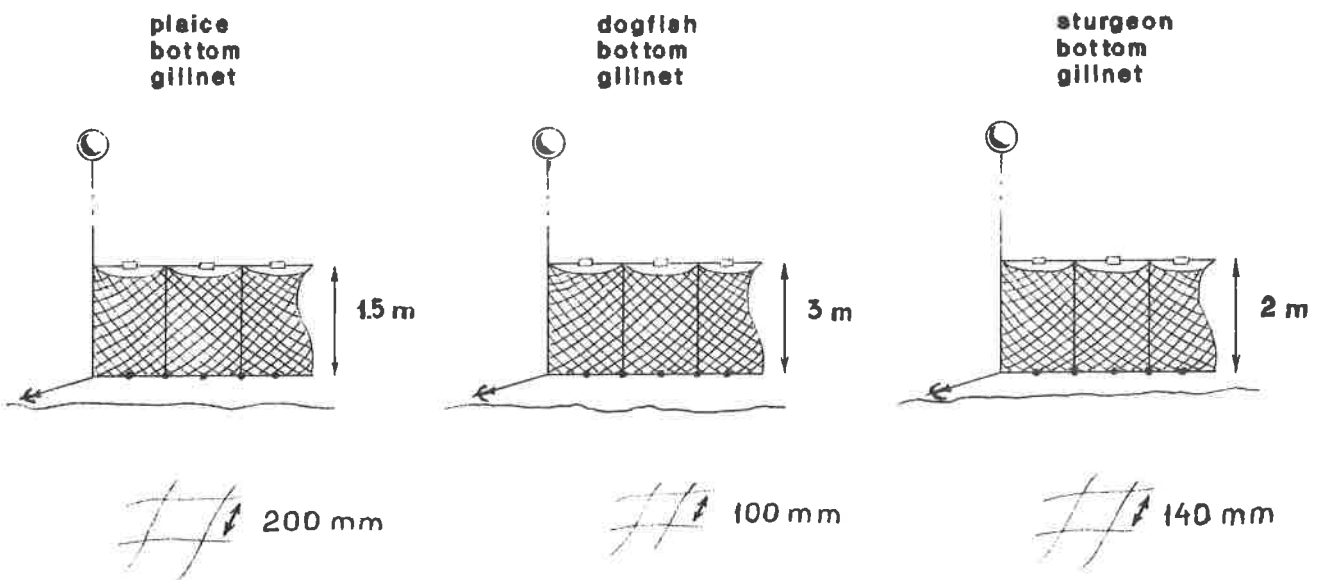

Fig. 2 Types of fishing net which are dangerous for dolphins off the Crimea coast

A STUDY OF THE REACTIONS OF HARBOUR PORPOISES TO VARIOUS BOATS IN THE COASTAL WATERS OF SOUTHEAST SHETLAND

P. G. H. Evans, Q. Carson, P. Fisher, W. Jordan, R. Limer, and I. Rees

Sea Watch Foundation (UK Mammal Society Cetacean Group),
c/o Department of Zoology, University of Oxford,
South Parks Road, Oxford, OX1 3PS, UK

INTRODUCTION Accelerating use of coastal waters by a variety of craft for both work and recreational purposes pose an increasing threat to porpoises and dolphins. Cavitation of the vessel's propeller, particularly at high speed, generates high frequency sound (above 1 kHz) which overlaps the frequencies used by small cetaceans for communication, navigation and food-finding. Additionally, there are potential dangers of direct damage to cetaceans from accidental collisions. Negative reactions by porpoises to vessels not only imply disturbance of the animals themselves but also affect line transect methodology for surveying them. The objective of this study was to observe the reactions of harbour porpoises (*Phocoena phocoena*), to the approach of different types of vessel under varying conditions. The Shetland Islands were chosen as a study area because it holds one of the highest summer concentrations of porpoises in Britain (Evans, 1993).

METHODS Extended land-based watches overlooking Mousa Sound, Southeast Shetland, were conducted on 81 days spread fairly evenly over the period May to October, 1993. Altogether, about three hundred hours of observation were made. Mousa Sound was selected because porpoises occur there regularly and in comparatively large numbers (Evans *et al.*, 1993). It is a relatively shallow (<50 m) stretch of water, about 2.5 km long and 0.8-1.0 km wide between Shetland mainland and the island of Mousa. The area is important as a feeding ground for porpoises.

During watches, the positions, orientation and behaviour of all porpoises observed were recorded, along with any vessel in the area. Times of arrival and departure of all vessels in the vicinity of the Sound were noted. Reactions were classified into three main categories: positive, negative or no reaction. Behaviour was categorised as a positive reaction if the individual or group changed direction in response to a vessel's approach by moving *towards* it. It was categorised as negative if, under the same circumstances, the individual or group changed direction and moved *away* from the approaching vessel. No reaction was recorded if the individual or group showed no obvious change in behaviour on vessel approach. Measurement was also made of the distance at which a negative response was observed.

For a comparison of reactions to vessels, boats were divided into the following types: yacht, speedboat, and fishing boat (all entering the Sound only irregularly), a small island ferry, (similar to other fishing boats, but making up to eight crossings a day), and a large P&O ferry (transiting the coastal waters of SE Shetland once a day, though passing through Mousa Sound less frequently). The relative frequencies of different vessel types in Mousa Sound during the study period is shown in Figure 1.

RESULTS Porpoises reacted differently to different types of vessel. Two-thirds of encounters with yachts (n = 9) resulted in porpoises moving towards them whereas 100% of encounters with speedboats (n = 10) resulted in porpoises moving away. Reactions to a variety of fishing boats (n = 29) were mixed, being equally divided between positive, negative and no obvious response. Of four encounters with the large P&O ferry, two were negative and two elicited no apparent response. By contrast, only 22% of reactions to encounters with the small Mousa ferry (n = 37) were negative, the largest category (46%) being for no response.

Although most of the sounds generated from maritime activities (besides sonar) are at frequencies lower than 1 kHz, when a surface vessel travels at high speed, the propeller may cavitate and produce much higher frequency sound (between 2 and 20 kHz) (Evans *et al.*, 1992). Measurements of various small craft (up to 15 m length, 240 hp engine) showed source levels ranging from 100-125 dB re μPa at 2 kHz and 60-105 dB re μPa at 20 kHz. Cavitation is also more likely to occur when the propeller is damaged. The power and speed of the vessel determines the intensity of sound produced. In an earlier study, the sound characteristics of various craft were measured in Cardigan Bay, West Wales in relation to possible disturbance of the local bottlenose dolphin population (Evans *et al.*, 1992). This indicated that dolphins should first hear a jet ski 450 metres away, an inflatable at 1 km, a small 6 hp outboard inflatable at about 1 km, and larger motorized vessels (up to 240 hp engine) between 1.1 and 3.1 km distance (above a background sea state of 3). In Mousa Sound, larger powered vessels elicited a negative response at greater distances than smaller ones in the following order (mean values in parentheses): large P&O ferry (1.25 km), fishing boat (334 m), speedboat (233 m), small ferry (97 m), and yacht (90 m).

The reaction of porpoises to a vessel depended upon the behaviour of that vessel. In all cases, if a boat stopped or changed direction and moved away from the porpoise, there was no reaction. If, on the other hand, the vessel changed direction and moved directly towards the animal (generally coincidentally, rather than purposefully to investigate it), then in 14 out of 15 cases the reaction was for the porpoise to move away. If the vessel showed no change of behaviour in the presence of porpoises, simply transiting past, then in eight out of 18 cases, there was no reaction. Only in the case of fishing boats, was the main response for porpoises to move away (three out of four cases), though the small sample size makes it unwise to draw any more firm conclusions.

On those occasions when the approach of a vessel elicited a negative response, the time taken for porpoises to reappear in the area varied also according to the vessel type. Whereas on seven (54%) out of thirteen occasions, porpoises responded to the regular small ferry by returning within one minute, after the large P&O ferry transited the Sound, no porpoise returned for at least six minutes. On four (50%) out of eight occasions after other fishing boats had elicited a negative reaction, porpoises returned within two minutes. The same applied to two (50%) out of four occasions when a speedboat had caused a negative response. These results should also be taken as tentative until larger sample sizes can be obtained.

During the months of May to September, the responses of porpoises to the approach of a vessel (irrespective of vessel type) changed seasonally. Whereas most porpoises moved away vessels during May and June, by July and August a neutral reaction was most common, and by September, the majority actually moved towards vessels (see Figure 2).

The type of response exhibited by porpoises depended upon group size. On 11 (73%) out of 15 occasions, lone porpoises moved away from an approaching vessel. A similar response was observed for adult-calf pairs, with negative reactions on nine (64%) out of 14 occasions. When two adults occurred together, on seven (58%) out of 12 occasions, porpoises moved away from approaching vessels, whereas on only one (12.5%) out of eight occasions, did groups of three or more respond negatively.

DISCUSSION & CONCLUSIONS Although these findings must be regarded as preliminary until more data can be collected, they indicate that under a variety of circumstances, porpoises react negatively to the presence of boats. The mixed responses observed suggest that porpoises may be associating a vessel's approach with the danger of physical injury rather than that there is general sound interference.

Porpoises may react negatively to any type of boat, but some, such as speedboats, elicit a negative response more than others, such as yachts. Porpoises respond at greater distances to larger, more highly powered boats than small ones, and if boats simply transit the Sound, their effect is smaller than if they are directly approached. A boat regularly in the area has a

smaller effect than similar powered vessels that enter it irregularly. Presumably this is because the regular island ferry is more familiar to porpoises in the Sound (and therefore viewed as less of a threat) than the array of other fishing vessels occasionally visiting the area.

Negative reactions are more common to any type of vessel early in the season, whereas later on in the summer, porpoises are more likely to appear unaffected or even to respond positively. This change in behaviour may be related to the reduced vulnerability of calves as the summer progresses as they grow older and learn to be more independent of their mother. This is supported also by the observation that lone individuals and adult-calf pairs are more likely to respond negatively to vessels than larger groups. However, an additional factor may be that during late summer, porpoises spend a higher proportion of time in social (and sexual) activity, leading to closer approaches to each other and perhaps also to other objects including vessels.

The question arises whether any negative reaction by porpoises to vessels has a long-lasting effect, for example by displacement from preferred habitats. During the summer months, Mousa Sound appears to be an important feeding ground for porpoises. A comparison of the frequency of boat encounters and numbers of porpoises recorded per observation period could therefore give some insight as to whether porpoises are being displaced. Figure 3 presents the results of this comparison and indicates that although at low rates of boat encounters there is no evidence for porpoises being displaced from the area, they may be affected at higher encounter rates.

ACKNOWLEDGEMENTS Grants in support of this project were kindly provided by the World Wide Fund for Nature UK (through funds donated by Bulgari Ltd), the Shetland Amenity Trust, and Scottish Natural Heritage. Assistance with fieldwork was provided by Maria Bavins, Victoria Gooday, Aaron Gould, and Rachel King. Finally, we thank Robbie Leask and Jimmie Birnie for skippering the "Queen of Hearts" during boat surveys, Martin Heubeck, and the staff of the SNH office in Lerwick for help at various stages of the project.

REFERENCES

- Evans, P. G. H. 1993. Whales and Dolphins in Shetland Waters. Shetland Cetacean Report, 1993: 8-14.
- Evans, P. G. H., Canwell, P. J. and Lewis, E. J. 1992. An experimental study of the effects of pleasure craft noise upon bottle-nosed dolphins in Cardigan Bay, West Wales. Pp. 43-46. In *European Research on Cetaceans* - 6. Editor P.G.H. Evans. European Cetacean Society, Cambridge, England. 254 pp.
- Evans, P. G. H., Fisher, P., Rees, I. and Wainwright, J. 1993. *Ecological studies of the Harbour Porpoise in Shetland, North Scotland*. Report to World Wide Fund for Nature. Sea Watch Foundation, Oxford. 52 pp.

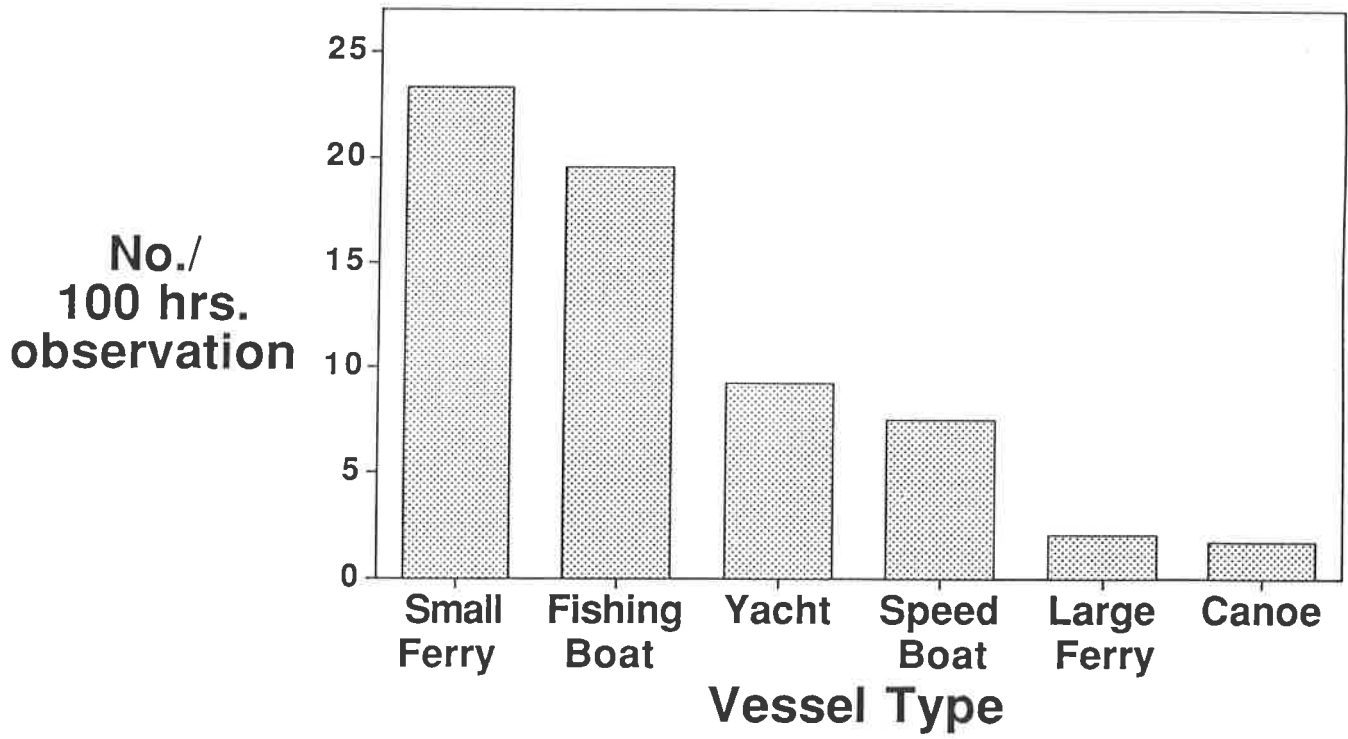

Fig. 1 Encounter rates of different vessels in Mousa Sound, SE Shetland

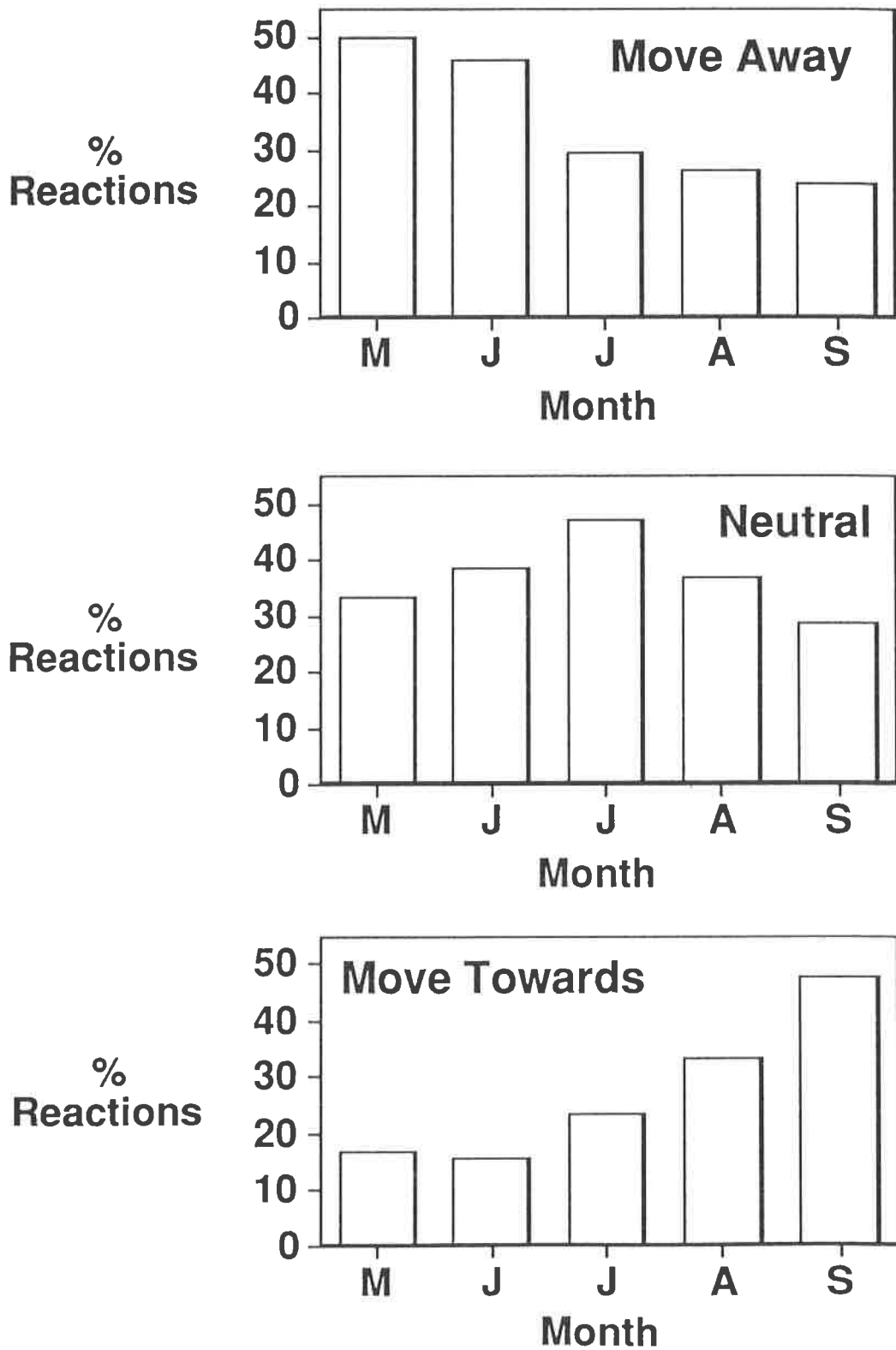

Fig. 2 Seasonal changes in the reactions to vessels made by porpoises in SE Shetland

SPERM WHALE ACOUSTIC SURVEY OFF THE CANARY ISLANDS, IN AN AREA OF HEAVY MARITIME TRAFFIC: PRELIMINARY RESULTS

M. André, A. G. Ramos and L. F. López Jurado

Centro de Mamíferos Marinos de Canarias, Dept. of Biology, University of Las Palmas de Gran Canaria, Culp, Apto. 550, 35016 Las Palmas de GC, Spain

Started in September 1993 and due to be completed in August 1994, a systematic acoustic survey of sperm whale groups, found in an area of heavy maritime traffic between the three main islands of the Canarian Archipelago, has been conducted once a month.

The main objective of these surveys is to understand the seasonal distribution of sperm whales in this relatively small area where accidental collisions with cetaceans, mainly sperm whales, are not uncommon.

A 13 m motor boat, completely fitted out for the detection and recording of cetacean acoustic signals, sails along line transects at a constant speed of 6 knots, and one minute recordings are made every fifteen minutes. The acoustic equipment includes a towed hydrophone connected to a DAT recorder. During daylight, a visual census is run as well, and the results compared to the acoustic detection.

Because of previous data collected while studying behavioural patterns, it was thought that the groups were likely to arrive in the area of interest at the end of January.

The preliminary findings show that sperm whales are present off the Canary Islands all year round and widely spread between the three main islands. The analysis of sea surface temperatures is giving some insight into the possible presence of the whales on the edge of cold water fronts.

The photo-identification of the individuals, will give information on the resident or transitory nature of the groups encountered.

MOLLY: A MINKE WHALE IN A SMALL LOCH ON THE SCOTTISH ISLAND OF LEWIS

R. Fairbairns*, J. Booth*, T. Walmsley*, J. Fairbairns*,
C. Menhenett** and J. Gordon***

*Sea Life Surveys, Dervaig, Isle of Mull, Scotland, PA75 6QL

**Magrec Ltd., Andes Chapel Hill, Morthoe, North Devon, EX34 7EA

***Wildlife Conservation and Research Unit, Department of Zoology,
South Parks Road, Oxford, OX1 3PS, UK

A minke whale, named Molly by local children, was first seen in Loch Grimshader, Isle of Lewis, Scotland, on 11 November, 1993. Twelve weeks later the same individual was still in residence. Loch Grimshader is a small loch, roughly 500 m wide by 2 km long, connected to the sea by a narrow entrance about 1 km long. Although minke whales are often found inshore, it is unusual to find one in such restricted waters for such an extended period of time. Initially it was assumed that the animal was trapped and unable to feed, and concerns for its welfare prompted an unsuccessful attempt to drive it out to sea. In response, a research team visited the loch twice on behalf of the International Fund for Animal Welfare. They documented the animal's behaviour and condition, surveyed the loch for food supplies, and assessed the whale's reaction to an underwater seal scarer due to be deployed by the local salmon farm.

The whale exhibited two main modes of behaviour seeming to correspond to "resting" and "feeding". The whale's dives were substantially longer than those recorded during fieldwork in the previous years off the nearby island of Mull. Underwater recordings were made to assess the animal's vocal behaviour. Surveys of the loch using a boat equipped with a fish finding depth sounder revealed substantial schools of saithe and whiting. The loch is also known by local fishermen to be a good location for catching herring in the spring. Thus, the indications were that the whale was healthy, had supplies of potential food and was probably feeding in the loch. Although the animal might well have been having difficulty finding its way out of the loch, the risks of attempting to drive it out would seem to outweigh any benefits. The seal scarer could be heard throughout the loch and the whale reacted to it by changing from resting to feeding mode when it was turned on.

THE DISTRIBUTION OF BOTTLENOSE DOLPHINS IN THE MORAY FIRTH, NORTHEAST SCOTLAND

B. Wilson*, P. Thompson*, P. Hammond** and S. Curran*

*University of Aberdeen, Dept. of Zoology, Lighthouse Field Station,
Cromarty, Ross-shire, IV11 8YJ, UK

**Sea Mammal Research Unit, NERC, Madingley Road,
Cambridge, CB3 0ET, UK

The Moray Firth contains an isolated and potentially vulnerable community of around 100 to 200 bottlenose dolphins. The international significance of the Moray Firth's dolphins and other wildlife is well established. As a result, it seems likely that new international agreements will demand greater protection for these animals and their habitats. Our limited understanding of the range and habitat requirements of the dolphins, however, constrains effective management under these directives. This study, therefore, examines the patterns of area use of bottlenose dolphins in the Moray Firth.

Bottlenose dolphins were located and photo-identified during regular standardised small boat surveys between 1990 and 1993. These surveys were conducted on a regular basis in the inner Moray Firth and, more occasionally, in areas outside.

Dolphin schools were found to vary significantly in size with season and with distance from the innermost areas of the Moray Firth. The number of dolphins sighted varied greatly with season and formed a pattern which was repeated over two years.

Individual dolphins varied in their use of the inner Moray Firth. Some were seen for short periods each year whilst others appeared to be resident. The ranges of these resident animals shifted seasonally, being furthest inshore in summer. Non-resident animals were found at other times of year in the outer Moray Firth and surrounding waters up to 110 km distant from the main study area.

A CETACEAN SURVEY IN THE IRISH WHALE AND DOLPHIN SANCTUARY: NORTH MAYO, SUMMER 1993

J. C. D. Gordon*, S. Fennelly**, S. Berrow** and E. Rogan**

*Wildlife Conservation Research Unit, University of Oxford,
Department of Zoology, South Parks Road, Oxford, OX1 3PS, UK

**Irish Whale and Dolphin Group, Department of Zoology,
University College, Cork, Ireland

In 1991, Ireland declared its waters to be a sanctuary for whales and dolphins. In response to this far sighted initiative, the Irish Whale and Dolphin Group and the International Fund for Animal Welfare planned a survey of cetaceans off the North Mayo coast using IFAW's research vessel *Song of the Whale*. This also included an assessment of the feasibility of whale-watching in the region.

The North Mayo coast was chosen as an area of particular interest because of the existence of two Norwegian whaling ventures on the Mullet Peninsula earlier in the century. During fifteen years of operation, these caught over 800 fin, sperm, sei and right whales.

Song of the Whale was active off the Mayo coast for 25 days during June and early July. A good visual watch was kept while the boat was at sea and hydrophones were monitored every 15 minutes. Data on sightings and sightings conditions, as well as the results of acoustic monitoring sessions, was recorded directly onto a PC using the LOGGER program. Poor weather for most of the research period meant that it was only possible to make two trips offshore to the edge of the continental shelf where most of the Norwegian catches had been made. Although no great whales were observed offshore, pilot whales were encountered regularly. Inshore, minke whales were observed on four occasions and there were indications that this species might be encountered predictably off some headlands. Other cetaceans encountered were common dolphins, bottlenose dolphins, Atlantic white-sided dolphins and porpoises. Cetaceans were heard on 28% of all acoustic monitoring sessions.

It was concluded that due to the modest density of cetaceans, the lack of sheltered waters and a number of logistical shortcomings, a substantial commercial whale-watching operation based on the Mullet Peninsula was probably not feasible. However, it was felt that cetaceans could serve as a useful figurehead for more broadly based wildlife tourism in the area.

OCCURRENCE AND GROUP SIZE OF BOTTLENOSE DOLPHINS *TURSIOPS TRUNCATUS* OFF KILCREDAUN HEAD, COUNTY CLARE, IRELAND.

O. Kiely*, S.D. Berrow* and B. Holmes**

*Department of Zoology, University College, Cork, Ireland

**Hydraulics and Maritime Research Centre, University College, Cork, Ireland

INTRODUCTION A pilot study to assess the feasibility of commercial dolphin watching was carried out in the Shannon estuary between May and October, 1993. A combination of land-based observation, boat transects and incidental sightings were used to obtain information on the numbers and distribution of bottlenose dolphins *Tursiops truncatus* in the estuary. This contribution focuses on the data gathered from land-based observations at Kilcredaun Head, Co. Clare (Fig. 1).

MATERIALS AND METHODS Between 5 July and 7 August, 1993, observations were made from Kilcredaun Head. This headland offers an excellent vantage point over the estuary and previous visits suggested that dolphins were regularly seen from Kilcredaun Lighthouse. Scan samples were made over the tidal cycle using a Kowa TSN-2 telescope with a x20 eyepiece. Scans were conducted every thirty minutes and each scan was approximately ten minutes in duration. During each scan the number and approximate group sizes of any dolphins observed were recorded, while their approximate location, predominant behaviour and reaction to any vessels in the vicinity of the dolphins were noted.

A group of dolphins was defined as one or more dolphins whose association and behaviour was apparently independent of other dolphins in the area. Group behaviour was recorded as travelling, foraging or other. Each behaviour was described as follows:

- (a) **travelling**: swimming together in one direction, often in tight formation;
- (b) **foraging**: moving in a variety of directions relative to one another, often dispersed against the current with accompanied surface rushes, repeated diving in a small area and tail-slapping;
- (c) **others**: physical contact with other individuals, often jumping and "playing" with floating objects.

RESULTS AND DISCUSSION 312 scan samples were made from Kilcredaun Head during the survey period. Each hour of the tidal cycle was sampled on twelve different days, making a total of 156 hours (2 x 12 x 6.5) of observation. The visibility of dolphins is highly dependant on weather conditions and resultant sea-state. Dolphins were recorded in 93% of samples taken in sea-state 2, but were recorded much less frequently during sea-state 5 and 6 (< 10% scans). This may be attributed to the poor visibility of dolphins during bad weather rather than the absence of the dolphins as they were occasionally recorded during adverse weather conditions.

Dolphins were observed in 45% of all scan samples taken from Kilcredaun Head. They were recorded in 58% of samples made at high water and 33% of samples made at low water (Fig. 2). On an ebb tide the proportion of dolphin sightings increased to a maximum three hours after high water when dolphins were recorded in 75% of samples (Fig. 2). On a flood tide most sightings were recorded at high water and a minimum (21%) recorded four hours after low water. Thus it appeared that dolphins moved up the estuary towards Kilcredaun Head at high water and remained in the vicinity of Kilcredaun throughout much of the ebb tide, subsequently returning seawards with the onset of the flood tide.

Sightings of single groups were recorded in 71% of samples. Two groups were recorded in 23% of samples, three groups in 4% of samples and four groups in 2% of samples. Median group size varied from 5 to 10 individuals which is quite common for this species, although larger group sizes, up to 27 individuals, were occasionally recorded (Fig. 3). In 59% of samples, a group of six or more dolphins contained at least one calf whilst the maximum number of calves observed was five in a group of 25 dolphins.

Dolphins were observed travelling in 59% of samples. Foraging behaviour was observed in 36% of samples and other behaviours in 5% of samples. Travelling was mainly recorded around slack water while the frequency of foraging behaviour rose to a maximum (76%) 2-3 hours after high water and three hours (78%) after low water. Other behaviour was mainly recorded in the period 2 to 0 hours before low water. On one occasion a dolphin was seen "playing" with a strand of kelp *Laminaria* sp. in its mouth and on two separate occasions individual dolphins were observed tossing fish into the air four or five times consecutively.

CONCLUSIONS Concurrent photo-identification studies of bottlenose dolphins on the Shannon Estuary have catalogued approximately 25 recognisable individuals, while a minimum estimate survey conducted in October 1993 recorded at least 58-68 individuals in estuary waters. This information has complemented data from boat transects and incidental sightings to produce recommendations for the development of commercial dolphin watching in the estuary.

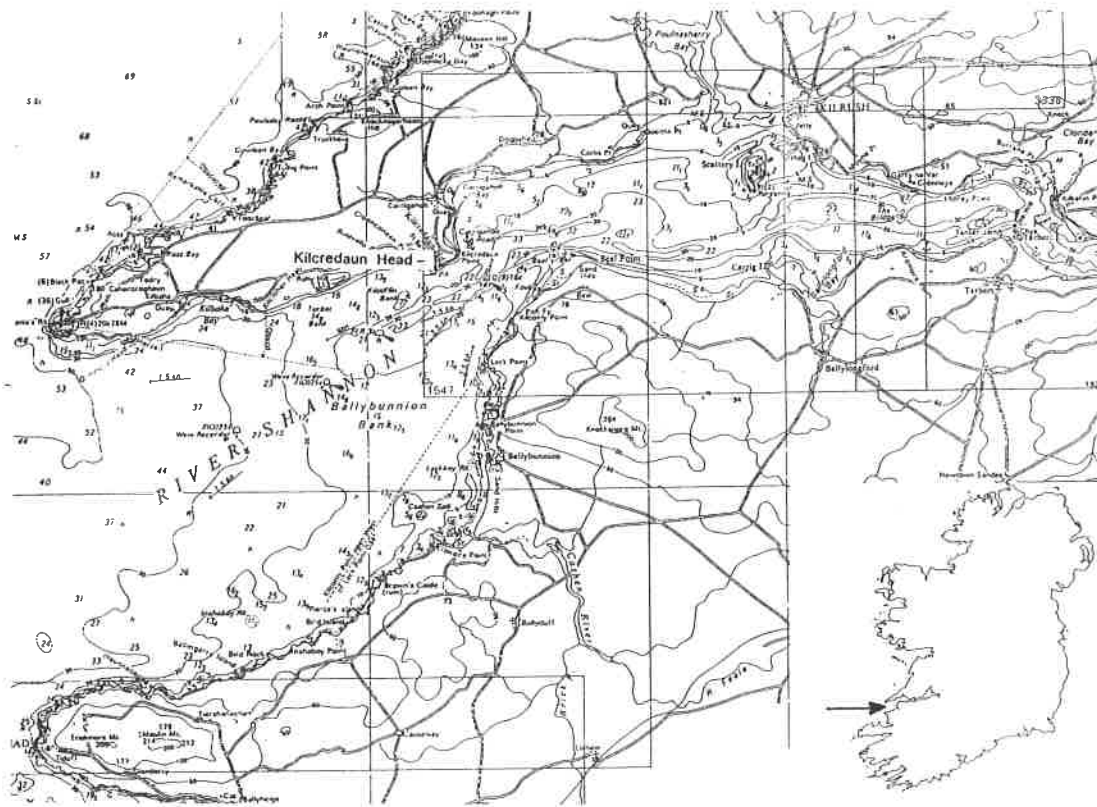

Fig. 1 Map of the Shannon estuary and study area. Inset shows location of Shannon estuary in Ireland (arrow).

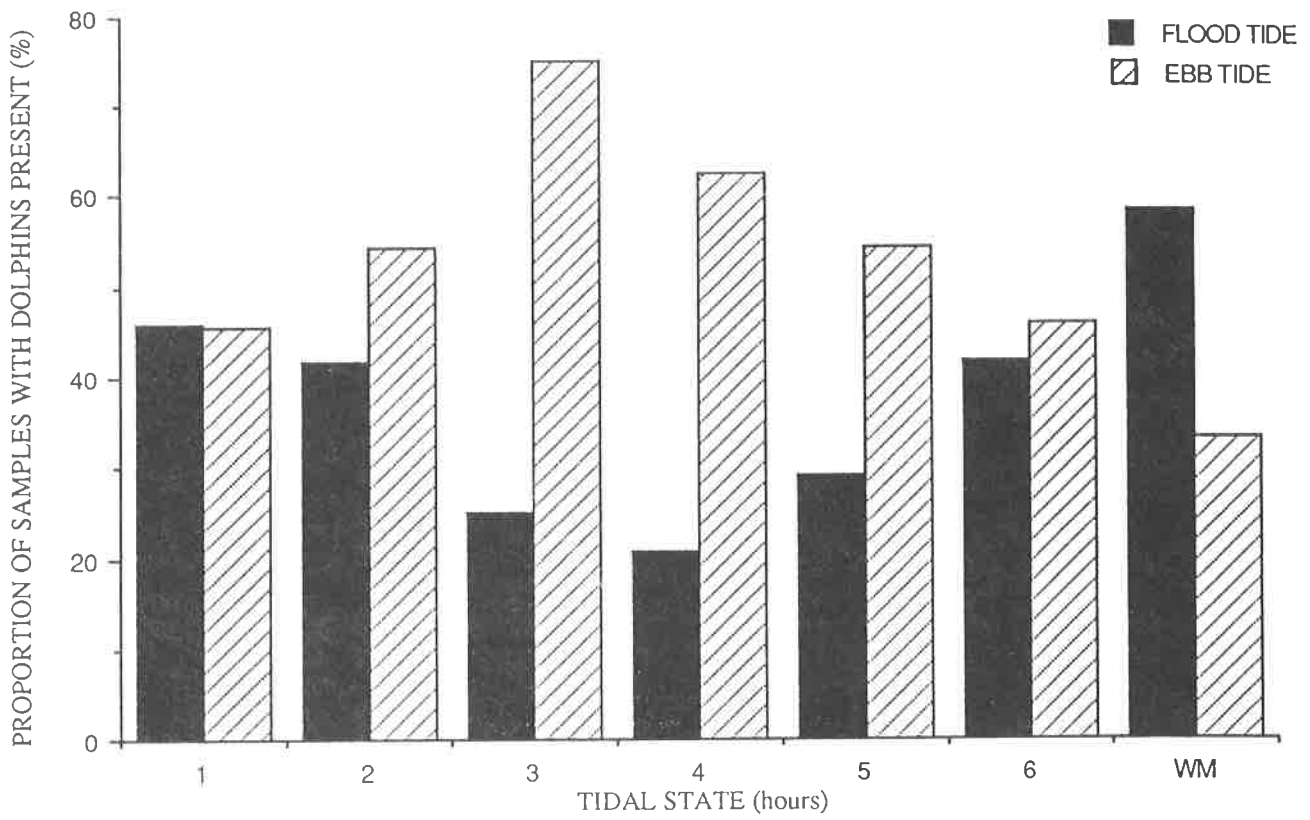

Fig. 2 Occurrence of dolphins over a tidal cycle.
(WM= High/Low Water Mark, n = 312)

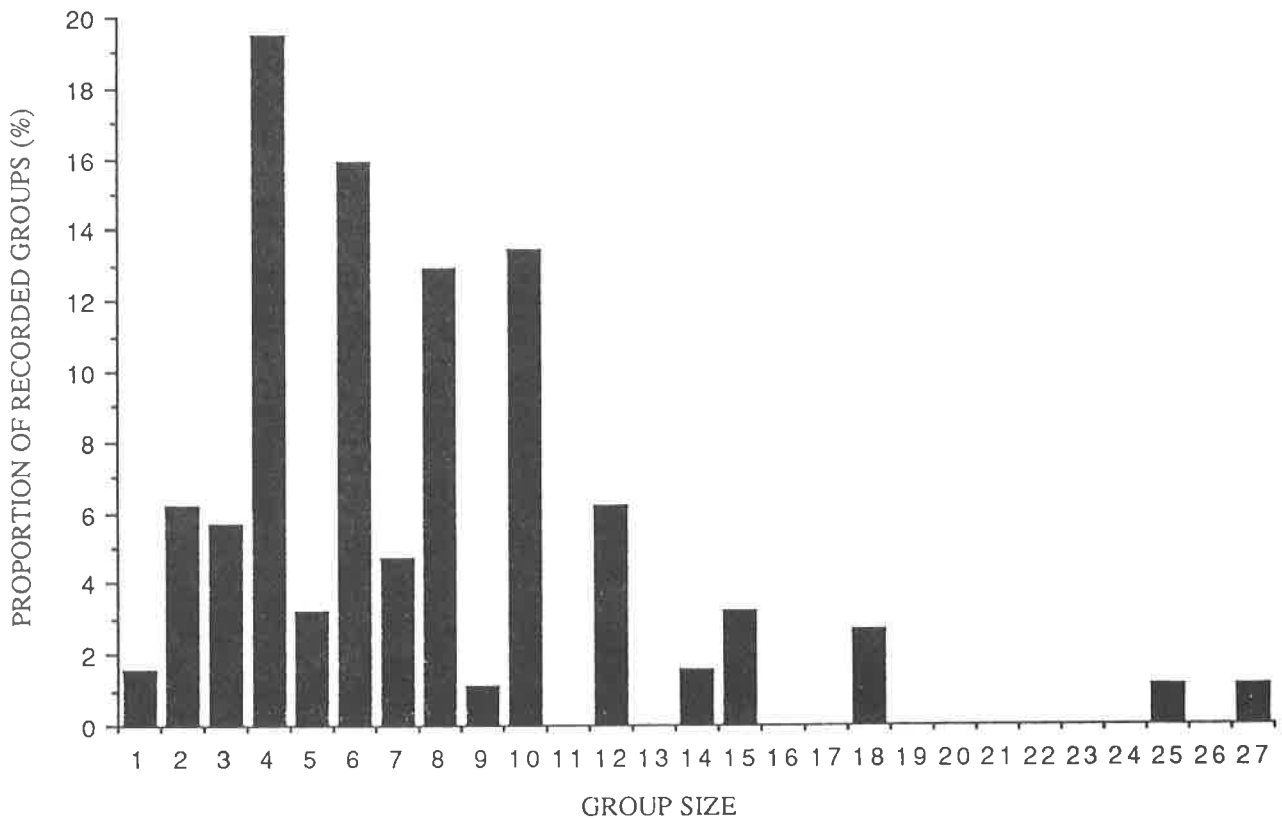

Fig. 3 Frequency distribution of group sizes (n = 196).

'TEMPORARY RESIDENCE' OF BOTTLENOSE DOLPHINS

TURSIOPS TRUNCATUS

Nicholas J. C. Tregenza

Cornwall Trust for Nature Conservation,
Five Acres, Allet, Truro, Cornwall, TR4 9DJ, UK

INTRODUCTION Most studies of bottlenose dolphins (*Tursiops truncatus*) have been started on inshore groups which have been resident for long periods. This study was started to quantify cetacean prevalence in a coastal area devoid of any such group of the species.

MATERIALS AND METHODS Regular quantified-effort seawatches from a range of locations around the coast of Cornwall were made by volunteers. Reports of sightings were also collected from the general public.

RESULTS

Sept 1990 to Sept 1991

Seawatches started in September 1990, and in the following 12 months, 717 hours of watching gave a sightings rate for bottlenose dolphins of 0.001 individuals/hr. An average of 0.2 casual reports per month were also received.

Sept 1991 to June 1993

Arrival - On 19 September 1991 a series of casual sightings started of a group of bottle-nosed dolphins whose average reported estimated size was 15. Casual reports to the end of February 1994 averaged 18 per month. The group of bottlenose dolphins arrived on the north-east coast of Cornwall and explored the coast at up to 50km/day, pausing for 1 to 3 days in and around various bays and inlets.

Residence area - A pattern emerged of 75% of 522 sightings coming from the Land's End peninsula area, along 24km of very exposed granite coast with two large sandy bays. Ten or more individuals made at least thirty distinct excursions averaging over 50km outside this area during the period up to the end of June 1993. Quantified effort watches gave a sightings rate of 0.02 groups/hr in the Land's End (1,235hrs) area and 0.003 groups/hr outside the Land's End area (1,536hrs).

787 hours of quantified effort watches in the Land's End area after the arrival of the group showed a sightings rate of 1.2 individuals/hr, until the end of June 1993. The largest groups seen were estimated at 20 - 25 individuals including 3 or 4 juveniles. The average estimated group size for all quantified effort sightings was 15.

July 1993 - Feb 1994

Departure - The group size fell abruptly in late June 1993 in both quantified effort seawatches and casual reports. 145 hours of seawatching in the Land's End area gave a sightings rate of 0.2 individuals/hr. The average estimated group size for all quantified effort sightings was four, close to the average of casual reports. The largest casual reports were estimated at ten individuals including 1 or 2 juveniles.

DISCUSSION The results clearly indicate the arrival and residence for 20 months of a group of about 20-25 bottle-nose dolphins. Then about two-thirds of the group disappeared. Their origin and fate are unknown, but the event recorded throws an interesting light on studies of 'long term resident' groups. Such groups may not be typical of the species.

HAVE YOU EVER HEARD OF THE PORPOISE? A UK SURVEY OF PUBLIC UNDERSTANDING

Nicholas J. C. Tregenza* and Katherine Stipala**

*5 Beach Terrace, Long Rock, Penzance, Cornwall TR20 8JE
**130 Wellington Road, Manchester, M14 6AR

METHODS Questionnaires were personally administered to shoppers in Liverpool, Oxford, Bristol and Penzance.

RESULTS

HAVE YOU EVER HEARD OF . . .	%YES	%NO	n
the DOLPHIN?	100	0	100
the PORPOISE?	84	16	100
a CETACEAN?	12	88	100
the BABOON / MINK / PILCHARD / TROUT?	100	0	50
the WALRUS? (<i>Odobenus rosmarus</i>)	92	8	50
the LING? (<i>Molva molva</i>)	76	24	50
the GOOSE-BARNACLE? (<i>Lepas anatifera</i>)	28	72	50
the MOONFISH ?(which is an invention for this study)	16	84	50

WHAT IS YOUR IDEA OF THE PORPOISE?		n
an open-ended question -	%	100
" a dolphin"	23	
"a mammal"	16	
"a fish"	9	
"a whale"	8	
"a seal"	5	
"a turtle"	5	
"no idea"	23	

Other answers included 'a squid', 'an Australian mammal', 'something fluffy and chubby', etc.

	%YES	n
Do DOLPHINS live around England?	76	50
Do PORPOISES live around England?	52	50

DISCUSSION Many people in the UK have a very weak concept of the porpoise, and some have none at all. This is not true of dolphins. The term harbour porpoise may add to the difficulty of acquiring a porpoise concept by subdividing it. Everyday language drops the specific adjective for many other species, even where there are actually other members of the genus found in the UK (e.g. the grey heron). We suggest that communicators should seek ways of stressing the similarities of porpoises to dolphins and should avoid the adjective 'Harbour' when it is not essential to public understanding. No 1994 ECS conference attendees favoured describing porpoises as dolphins.

OBSERVATIONS OF HARBOUR PORPOISE IN WEST WALES, 1993

Chris Pierpoint, Sarah Earl and Mick Baines

West Wales Marine Monitoring Group, Dyfed Wildlife Trust,
7 Market Street, Haverfordwest, Dyfed, SA61 1NF, UK

INTRODUCTION Systematic observations from land have been used to monitor the relative abundance and to study some aspects of the ecology of harbour porpoise (*Phocoena phocoena*) at two locations in West Wales. The objectives of the project were:

1. To quantify seasonal changes in the relative abundance of harbour porpoise at Strumble Head and Ramsey Sound, Dyfed.
2. To further investigate the influence of the tidal cycle and of undersea topography on porpoise behaviour.
3. To catalogue descriptions of observed behaviour.
4. To carry out a preliminary study to record the effects of boat activity on porpoise activity.

A preliminary investigation in Ramsey Sound (Pierpoint, 1993) described a strong tidal rhythm for porpoise behaviour consistent with foraging. The project also highlighted certain problems of methodology which may compromise the compatibility and value of the data collected from cliff-top observations. Specifically, during each observation period, as the total number of porpoises present within the study area is likely to be in flux, systematic monitoring is required to record variation in relative abundance over time. However, problems may arise when an undetermined proportion of individuals remain within the study area for prolonged periods; the frequency at which re-sightings of these porpoise are recorded will strongly influence summary statistics of relative abundance. Methodology used during the present work attempts to control the maximum frequency at which re-sightings of individuals are recorded by dividing each observation period into a series of systematic, visual sweeps or scans.

METHODS A series of systematic, land-based watches were carried out at two locations in Dyfed, West Wales: at Strumble Head between 17 June and 10 December 1993, and at Ramsey Sound from 20 August to 10 December 1993. Harbour porpoises are widely distributed throughout the area; these two sites were chosen because of the high incidence of sightings from other watches.

Each observation period itself consisted of a series of standardised, unidirectional sweeps of the study area using 7 x 50 binoculars and a telescope (i.e: 20x). Each sweep was five minutes duration although ten minute sweeps were occasionally necessary when several groups of porpoise were present. The duration of each sweep was selected with the aim of minimising the chance of recording any individual more than once, whilst maximising the probability of recording each porpoise present. The number of porpoises seen and details of observed behaviour were recorded onto specifically designed recording forms.

The mean number of sightings per standard sweep (\pm SE) has been used as an index of relative abundance for comparisons between observation days. In addition, the maximum number of individuals recorded in any single sweep ('Hi count') has been used to approximate to the highest number present during the observation period.

RESULTS

Relative abundance (June - January)

Variation in sightings per unit effort (S/UE) was often high between consecutive observation days. However, results from Strumble Head (17 June 1993 to 10 January 1994) show relative abundance to be highest from late July to September with a distinct peak in early September. This is reflected by the highest count of individuals on each observation

day, which reached a maximum of 111 on 10 September 1993 ($S/UE = 30.2 \pm 7.87$ SE). From 17 June to 27 July, S/UE exceeded 3.0 for one observation period only ($n=9$). Similarly, for observations from October onwards, S/UE exceeded 3.0 once only ($n=8$). From 2 August to 25 September, $S/UE > 3.0$ for seven observation periods ($n=13$).

At Ramsey Sound, highest counts peaked at ten on 2 and 14 September ($S/UE = 4.42 \pm 0.645$ SE and 5.22 ± 0.429 SE respectively). From 20 August to 1 October, S/UE was greater than 4.0 on six occasions ($n=18$), but exceeded 3.0 on only one occasion from 1 October onwards ($n=17$). The number of days on which no porpoise were recorded increased from 0 to 7 between these periods.

The tidal cycle

At Ramsey Sound, the number of sightings was significantly higher on the ebb and at LW-slack than would be expected if sightings were equally distributed over the tidal cycle in proportion to observer effort ($X_2 > X_{23}$; $P < 0.005$). Because of this, a subset of observation periods carried out during the ebb and LW-slack has been used to compare relative abundance between observation days. During the ebb, a tidal race develops within the study area and during this period, 74% of sightings were of porpoise surfacing directly into the tidal stream. Porpoises were frequently observed surfacing repeatedly in the same position, maintaining that position in the tidal race for prolonged periods. Sixty-four percent were again orientated into the direction of the tidal stream as the tide flooded. At LW-slack, 52% of sightings were orientated towards the north; porpoises were frequently observed travelling north at this time, following prolonged periods of foraging in the ebb tidal race.

At Strumble Head, relative abundance was highest during the flood. A histogram of S/UE for each half hour after high water shows two peaks: during the flood and during the first hour of the ebb. Sixty-two percent and 47% of sightings during the ebb and the flood respectively were orientated directly into the tidal stream. Data from 10 September 1993 is atypical, however, with 70% of sightings during the flood recorded as multi-directional. If these data are excluded from the analysis, 62% and 64% of sightings during the ebb and the flood were of porpoises surfacing directly into the current.

Behavioural descriptions

Resting at the surface - Most often observed during slack tide and with a calm sea, particularly following intense periods of activity in a tidal race. Individual porpoise were seen to 'lie' at the surface for up to ten seconds (exceptionally 58 and 63sec) with the top of the head, dorsal fin and much of the back visible.

Milling and Rafting - Milling was frequently observed at or close to slack tide. Small groups (typically 1-4) which had often remained stable over periods of foraging, would come together to form a larger compact group, surfacing slowly in different directions and remaining close together. Rafting was observed on one occasion only, at Strumble Head: a group of 25-30 individuals were seen lying on the surface at low-water slack, in a tight group, orientated in the same direction. After approximately ten secs, they dispersed abruptly, dived and then immediately re-formed. This was repeated a further three times before the group eventually dispersed.

Foraging - Porpoises were typically observed surfacing with only the arched back and dorsal fin visible above the surface. Individuals observed in tidal races often surfaced repeatedly at the same location, orientated directly into the tidal stream. Speed of surfacing often appeared related to the strength of the tidal stream as individuals maintained their position within the tidal race. Groups of up to ten were observed surfacing quickly in a line abreast but these larger groups were usually temporary associations, disbanding after short periods of relatively intense activity. Northern gannets (*Sula bassana*) were frequently associated with this activity, and gulls (*Larus* spp.) were seen scavenging from surfacing porpoise. An example of surfacing frequency during this activity is: 9, 7, 4, 7, 58, 7, 7, 7, 5, 7, 9, 7, 63, 7 sec - Adult/calf surfacing in synchrony, periphery of ebb race, 2 September 1993.

Surface rushing - During periods of intense foraging, porpoise were observed 'cutting' along the surface for short periods, often involving a rapid change of direction perhaps in pursuit of prey close to the surface.

Breaching - Breaching was observed 35 times in 120 observer hours at Strumble Head, and six times in 100 hours at Ramsey Sound, and was associated with particularly animated periods of activity. Partial breaches were observed with the anterior part of the porpoise exposed but the flukes remaining below the surface. Full breaches were also observed with the porpoise clearing the surface completely and re-entering water cleanly, head first. Breaching seemed to occur both during periods of intense foraging, and in an apparently social context with adults observed breaching over other adults, or adult-calf pairs.

Tail flip - Observed on three occasions at both Ramsey Sound and Strumble Head, individual porpoises would roll forwards quickly, lifting the flukes in a 180 degree arc and exposing the posterior ventral surface. The head was not exposed above the surface.

Travelling - Travelling was observed as prolonged, apparently determined movements of porpoise in a single direction. When travelling, individuals often surfaced at regular intervals with the speed of travel closely related to the strength of the tidal stream.

DISCUSSION AND CONCLUSIONS During the study period, the relative abundance of harbour porpoise was highest from late July to early September. Systematic observations are on-going at both locations to give a longer-term perspective, but the present data are in agreement with studies of the species in Shetland, Scotland (Evans, *et al.*, 1993) and in the Bay of Fundy, eastern Canada, where highest numbers occur over the same period, coinciding with maximum surface sea-water temperatures and the largest catches of herring (*Clupea harengus*) (Gaskin and Watson, 1985).

The reason for the dramatic increase in relative abundance at Strumble Head in early September is unclear at present. Unusually large numbers of gannets (c.750) observed plunge-diving amongst over 100 porpoise suggest a high density of prey. The atypical dominance of multi-directional surfacing over prolonged orientation directly into the tidal stream, may also reflect a high density of both prey and porpoise. Alternatively, the sudden increase in numbers may represent a social aggregation. Male and female harbour porpoise both have highly seasonal reproductive cycles and morphological evidence suggests that the species may have evolved a mating system of male promiscuity and sperm competition (Read, 1993). Typically encountered in small groups, it is perhaps likely that larger breeding aggregations form to increase the probability of individual reproductive success. In the north-west Atlantic, ovulation and conception are believed to take place in late June with parturition in mid-May after a gestation period of approximately 10.6 months (Read, 1990). Very small calves have been reported from the present study area in mid-May (J. Poole, pers. comm.; Bullock, pers. comm.). This infers conception in June or July and suggests that large aggregations in early September are more likely to be a consequence of high prey density. In the present study, adults were observed with calves of approximately half adult size in late July and August.

Present results show a strong relationship between habitat use and the tidal cycle at both study areas. Most observations during both the ebb and flood, were consistent with foraging behaviour and associated with the formation of tidal races. The observations suggest that by maintaining position, orientated directly into the tidal stream, porpoises increase the probability of finding and capturing prey. It is not known whether individual porpoises visit the study areas repeatedly. In a study of radio-tracked porpoises, all observed movements coincided with the direction of tidal flow in major channels (Read, and Gaskin, 1985) and observations of recognisable individuals have shown consistent patrolling patterns (Gaskin and Watson, 1985).

Although harbour porpoises have a widespread distribution off the coast of West Wales, some coastal locations, particularly certain headlands and sounds between islands and the mainland, provide good opportunities to study aspects of the ecology of harbour porpoise from land. Systematic methodology may be used to collect data relating to foraging ecology and conflicts with local fisheries or interactions with boat traffic, for example. It may also provide a means to monitor trends in relative abundance at specific locations, although sampling must take into account variation in relative abundance over the tidal cycle before considering seasonal or longer-term variation.

REFERENCES

- Evans, P. G. H., Fisher, P., Rees, I. and Wainwright, J. 1993. *Ecological studies of the harbour porpoise in Shetland, North Scotland: summary report*. Sea Watch Foundation, Oxford. 55pp.
- Gaskin, D. E. and Watson, A. P. 1985. The harbor porpoise, *Phocoena phocoena*, in Fish Harbour, New Brunswick, Canada: Occupancy, distribution, and movements. *Fish. Bull.*, 83(3): 427-442.
- Pierpoint, C. J. L. 1993. Observations of harbour porpoise (*Phocoena phocoena*) in Ramsey Sound, Dyfed. Pp. 39-43. In. *European Research on Cetaceans - 7*. (Ed. P.G.H.Evans) Proc. 7th Conf. ECS, Inverness, 18-21 February 1993. European Cetacean Society, Cambridge.
- Read, A. J. 1990. *J.Can. Zool.*, 68(2): 284-288.
- Read, A. J. 1993. Social behaviour of harbour porpoises: insights from morphology. Pp. 32-33. In. *European Research on Cetaceans - 7*. (Ed. P.G.H.Evans) Proc. 7th Conf. ECS, Inverness, 18-21 February 1993. European Cetacean Society, Cambridge.
- Read, A. J. and Gaskin, D. E. 1985. Radio tracking the movements and activities of harbour porpoise, *Phocoena phocoena* (L.), in the Bay of Fundy, Canada. *Fish. Bull.*, 83(4): 543-552.

**MEAN SIGHTINGS PER UNIT EFFORT
STRUMBLE HEAD**

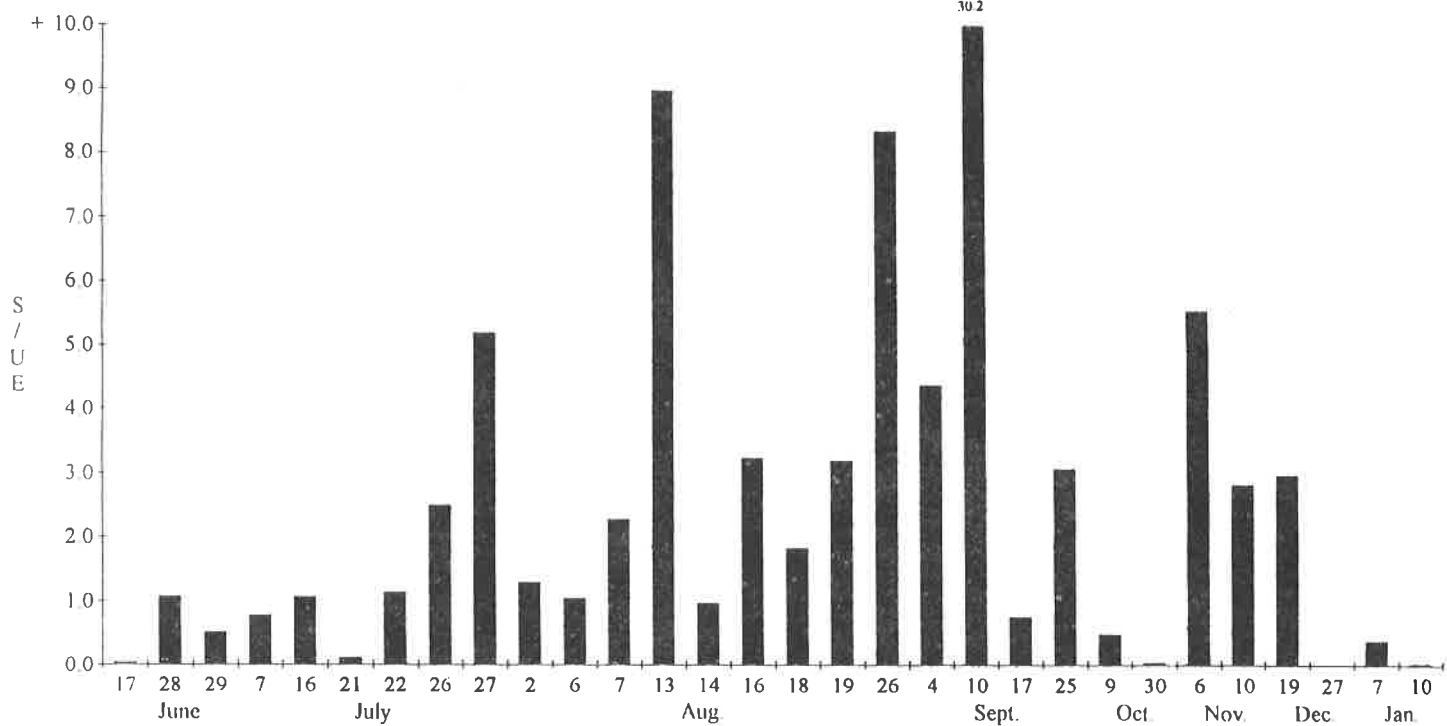

Date	17/6	28	29	7/7	16	21	22	26	27	2/8	6	7	13	14	16	18	19	26	4/9	10	17	25	9/10	30	6/11	10	19/12	27	7/1	10
Hi count	3	6	4	5	3	1	5	14	27	5	5	10	27	12	7	9	9	24	30	111	3	10	3	1	6	5	10	0	1	2

**SIGHTINGS/UNIT EFFORT RELATIVE TO HW
STRUMBLE HEAD**

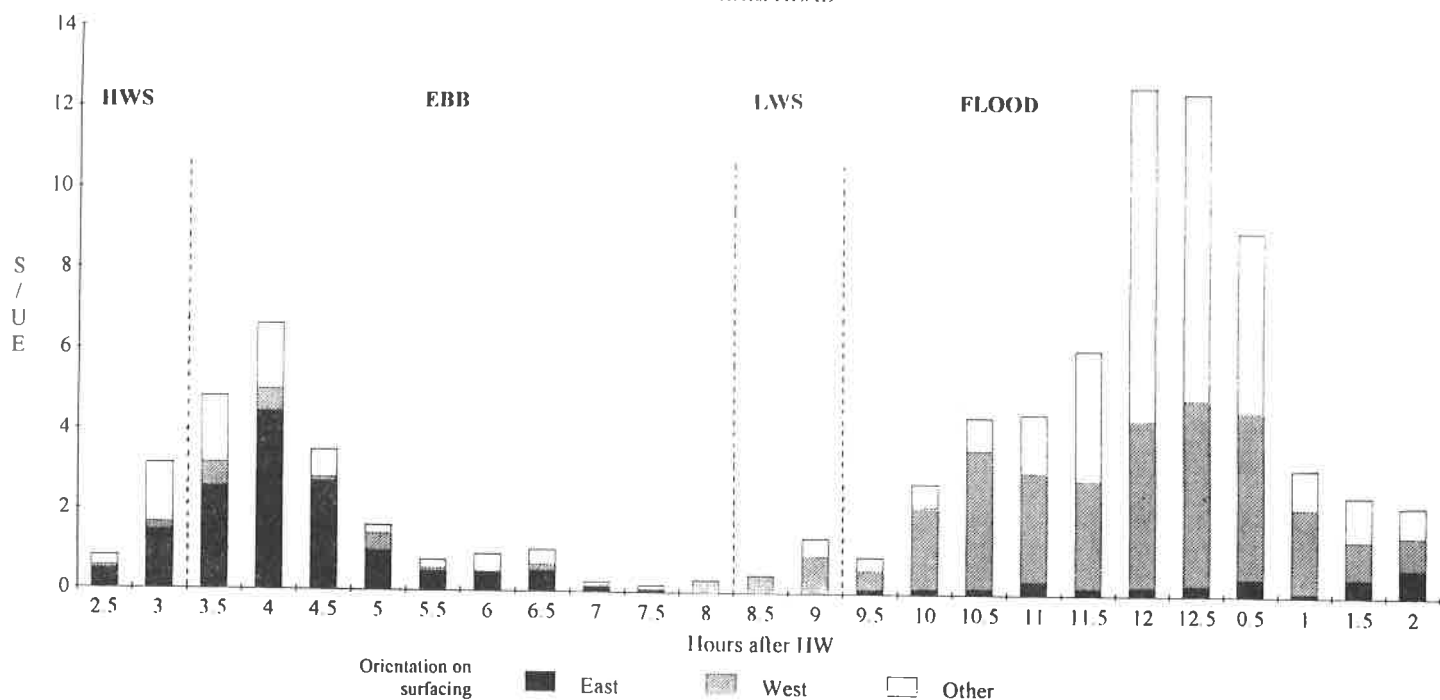

RAMSEY SOUND: DISTRIBUTION OF SIGHTINGS

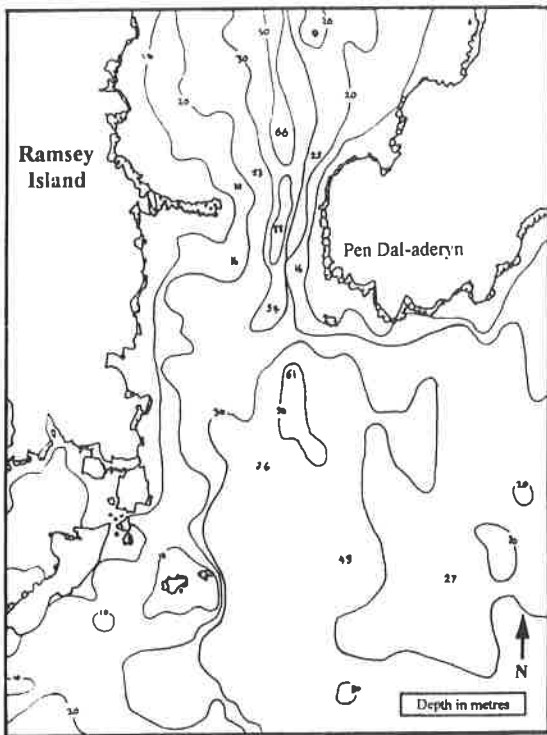
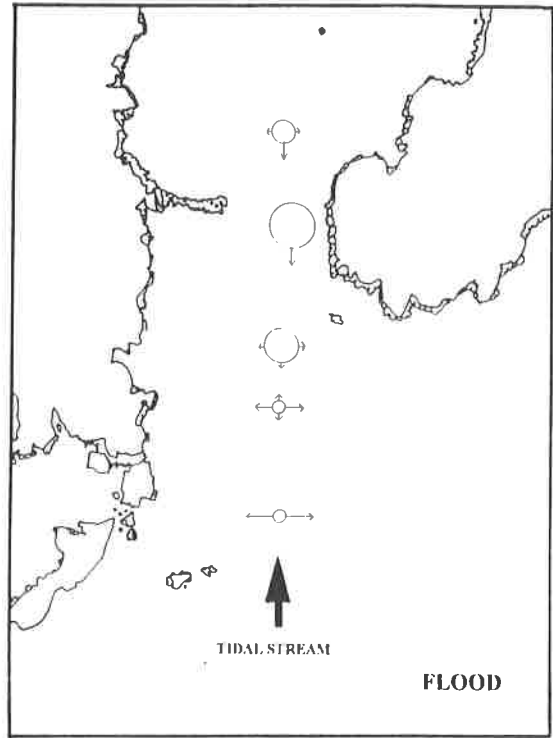
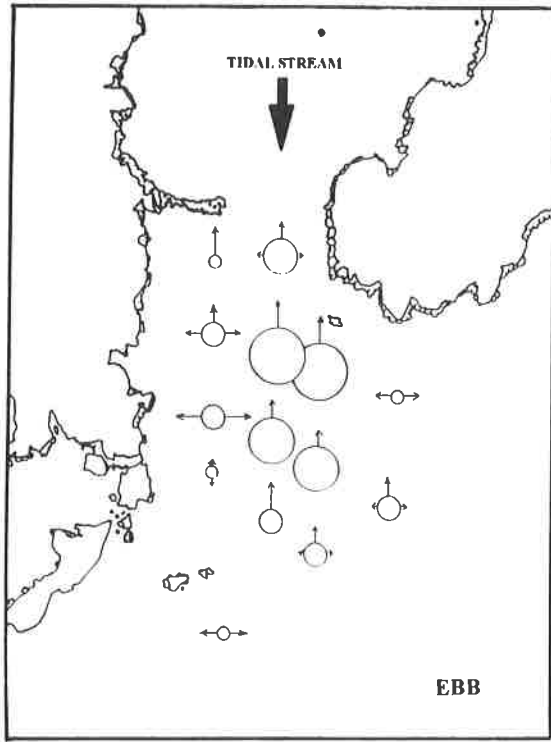

KEY

Estimated positions of sightings are centred within sectors delimited by the bearings of prominent landmarks and by their position relative to that of the tidal race (eg central in the tidal race or in upwellings on its eastern periphery). Radii of circles are proportional to number of sightings. Arrows are proportional to the percentage of sightings orientated in a particular direction 'Other' includes multi-directional surfacing (surfacing in a series of different directions). The direction of the tidal stream is shown

○ = 0-10	○ = 51-100	○ = 200+
○ = 11-50	○ = 101-200 sightings	
↑ = 75-100% of sightings	○ = North	
↑ = 50-75%	○ = South	
+ = 25-50%	○ = Other	

(<25% not shown)

FIN WHALE ABUNDANCE IN THE EASTERN NORTH ATLANTIC, ESTIMATED FROM THE FRENCH PROGRAM MICA-93 DATA

Michel Goujon*, Jaime Forcada** and Geneviève Desportes***

* 6 Cours Kennedy, 35000 Rennes, France

**Department of Animal Biology, Faculty of Biology, University of Barcelona,
08028 Barcelona, Spain

***Bregnor, DK-5300 Kerteminde, Denmark

INTRODUCTION A line transect survey to assess cetacean abundance was conducted in the temperate waters of the eastern North Atlantic during the summer of 1993 by the French institute IFREMER. A total area of 204,929 n.miles² was covered in three different cruises with observers from France, Spain, Belgium and Italy. The area prospected (Fig.1) includes most of the IWC "Spain-Portugal-British Isles' stock of fin whales" (Donovan, 1991). Fin whale (*Balaenoptera physalus*) data are analysed to produce an estimate of density and abundance for the surveyed area. The results of the analysis are then compared to those of other surveys conducted in previous years.

METHODS The area was stratified into six sub-areas containing a zig-zag cruise track (Fig.1). The survey was conducted with a 38 metre long trawler, cruising at 10.5-11.5 knots with an observation platform situated 6.2 metres above sea level. Sighting angles and distances were collected following line transect sampling methods (Buckland *et al.*, 1993).

Only small cetaceans were approached when sighted, in order to estimate school size and identify the species. However, distance data were collected for all cetaceans encountered. Many large rorqual sightings were unidentified to species level and for that reason two analyses were carried out; one for identified fin whales and another one for fin whales and unidentified large rorquals pooled together. Data were analysed with the computer program DISTANCE V.2.0 (Laake *et al.*, 1993).

RESULTS A total of 3,562 n.miles were covered on effort, with the appropriate Beaufort sea state, providing a representative sample of data for the analysis. Overall, 233 sightings of large rorquals were made, of which 199 were primary (those made whilst searching on effort) (Table 1).

For the analysis, only primary sightings in the abeam line were used, perpendicular distances were truncated at 2000 m, and only effort in Beaufort sea state between 0 and 3 was chosen. In these conditions, the best model for the 45 primary sightings of fin whales gave an abundance of 3,589 individuals (SE 866). When all the large rorqual data was pooled together, the model chosen for the 158 primary sightings was a one term Fourier series, and abundance was estimated at 7,507 whales (SE 1,127).

However, the frequency distribution of perpendicular distances shows how whales were hardly identified at high perpendicular distances and explains why the estimate with only fin whale sightings was biased downwards. An estimate with only fin whale sightings and perpendicular distances truncated at 100 m was attempted, producing an estimated abundance of 6,017 fin whales (SE: 1,913), more similar to the number obtained when all the sightings of large rorquals were pooled.

DISCUSSION Variation in population size when the two different sets of data were used can be interpreted as the lack of specific identification of many animals relatively close to the transect line. If most of these animals are discarded because they are not identified, the estimate is clearly biased downwards. Therefore, a population size of only 3,589 animals is unreliable.

According to Table 1, the only identified large rorquals during the survey were fin whales. For that reason the estimate of 7,507 whales must correspond largely to the fin whale population and is unlikely to be substantially biased.

In the present survey, density was estimated as 0.039 whales per n. mile², which is a similar value to the density found in 1989 by Buckland *et al.* (1992), which was 0.045 whales per n. mile². Moreover, abundance in the Bay of Biscay area was estimated at 8,078 fin whales (SE 2,686), and therefore, a population size of 7,507 fin whales seems reliable.

ACKNOWLEDGEMENTS Thanks are due to all the observers who participated in the cruises and also the crew of the "Croix Morand". Loic Antoine, Phil Hammond and Anne Collet participated in the preparation of the project. Very special thanks are due to Steve Buckland, who provided valuable suggestions for the analysis.

REFERENCES

Buckland, S. T., Cattanach, K. L. and Lens, S. 1992. Fin whale abundance in the eastern North Atlantic, estimated from spanish NASS-89 data. Rep. Int. Whal. Commn, 42: 457-460.

Buckland, S. T., Anderson, D. R., Burnham, K. P. and Laake J. L. 1993. *Distance sampling. Estimating abundance of biological populations.* Chapman and Hall, London.

Donovan, G. P. 1991 A review of IWC stock boundaries. Rep. Int. Whal. Commn. (Special issue 13): 39-68.

Laake, J. L., Buckland, S. T., Anderson, D. R. and Burnham, K. P. 1993. *DISTANCE User's guide V2.0.* Colorado Cooperative Fish and Wildlife Research Unit, Colorado State University, Fort Collins, CO. Pp 72.

Table 1 Sightings of rorquals made during the Mica-93 campaign.
 (Minke whales were not included in the category of unidentified large whales)

Species	Sightings		total
	primary	secondary	
Fin whales	63	7	70
Unidentified large whales	144	16	160
Minke whales	3	0	3

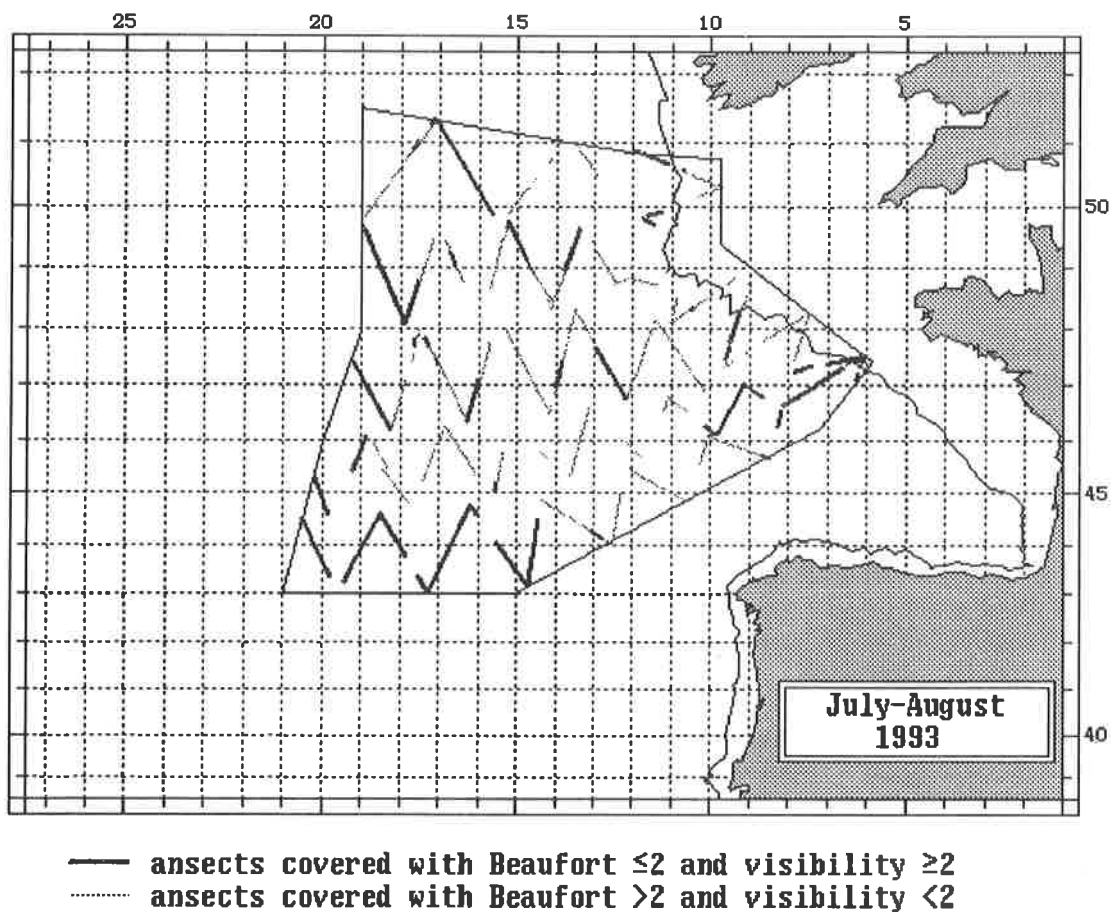

Figure 1 Transects covered during the Mica-93 sighting survey campaign

ANALYSIS OF THE ROLE OF VOLUNTEERS IN A FIELD STUDY ON THE DISTRIBUTION AND DYNAMICS OF CETACEANS ALONG THE SOUTH-EASTERN COAST OF SPAIN

A. Cañadas and R. Sagarminaga

Asociación Proyecto Alinitak,
C/ Jazmín 12, 28033 Madrid, Spain

INTRODUCTION Since 1992, we have been carrying out a long-term research program on the distribution and dynamics of cetaceans along the southeastern coast of Spain with the participation of volunteers. We study five species: bottlenose dolphin *Tursiops truncatus*, common dolphin (*Delphinus delphis*), striped dolphin (*Stenella coeruleoalba*), long-finned pilot whale (*Globicephala melas*) and Risso's dolphin (*Grampus griseus*).

The participation of volunteers (a method largely used by North American researchers) sailing on board the research ship, besides being the main source of financial support necessary for carrying out the research, and helping us with the navigation and collection of some of the data, involves a combination of scientific research with environmental education goals. In order to avoid the risks of disturbance which could be created by an uncontrolled approach to cetaceans by different groups of people, the research project follows very strict conduct guidelines.

AIMS The overall aim of this study is to establish as accurately as possible the general situation regarding cetaceans in this area. In order to simplify the work, we have subdivided our main aims into more specific research goals: (1) to determine which species are migratory or sedentary in the region; (2) to identify the more stable groups in the area and determine their distribution, dynamics and possible relations with oceanographic, geographic, meteorological and ethological parameters; (3) to collect data concerning behaviour and social structure of the different groups; and (4) for the creation and development of a photo-identification catalogue using colour slides.

METHODS

Calendar of Campaigns In order to achieve these aims, a long-term research program is necessary. The first phase which has already involved two years of fieldwork, will be extended for another two or three years. The fieldwork is mainly from June to September, but includes some days in April. This research calendar is restricted mainly by economic and meteorological factors.

Type of navigation and data recorded during sailings The research ship sails on nearly all days during the season except for when meteorological conditions do not allow it. We normally sail an average of eight to ten hours per day, leaving port at sunrise and returning in the afternoon.

During the sailings, whether cetaceans are sighted or not, a considerable number of parameters are recorded periodically, such as the position of the ship every hour and at every change of course or halt, weather conditions, sea state, notable biological events (abundant plankton, jellyfish, fish schools, sharks, sea turtles, sea birds, etc), and fishery activities.

Actions undertaken during cetacean sightings When a group of cetaceans is sighted, the ship alters course towards them. Immediately the angle of the groups with respect to the ship's previous course is recorded, as well as the position and the other navigational, meteorological and oceanographic data mentioned above. The next step is to determine the species, the number of individuals, their activity at the time of the sighting (feeding, jumps, copulations, etc.), and the direction they were following, if they were not at rest. If a closer

contact is possible, more data are recorded on the group's structure and behaviour, as well as video filming and photographic recording. On some sightings, the groups located are followed at a distance of over 300 metres in order to observe behaviour and displacements without interference by the ship.

RESULTS After two years of field work, we are now analysing all the data collected. In total, we have:

Number of sightings:	225	Colour slides taken:	over 7,000
Number of indiv. sighted:	c. 8,330	Days at sea:	158
Total sighting time (in hours):	211	Total miles travelled:	4,020
Average duration of sight. (min.):	56	Total time at sea (in hrs):	1,167

Data recorded are introduced daily onto computer files for later analysis.

SYSTEM OF VOLUNTEERS The fieldwork of this research is almost entirely financed by the volunteers. Every nine days, seven to eight volunteers participate actively in the research. Volunteers come either through universities or through specialised travel agencies. Before their arrival onboard, each volunteer has received an extensive information package and is asked to sign a crew declaration form stating his accordance with the volunteer system. This form we consider of vital importance in order to avoid tourists being mis-informed tourists which would jeopardise the continuity of the research.

On their arrival, the volunteers are given an introductory talk on the research and their tasks for the sailing days. During the next days, slide shows and talks are given on the research as well as on other marine environmental issues. Furthermore, the ship has books and videos for those volunteers who are specially interested in certain subjects.

Ship's normal duties include a watch rota which gives each volunteer three or four hours of watch. During sightings, each volunteer is assigned a special post in order to help the researchers with the collection of data.

In order to ensure a homogeneous sighting effort throughout the campaign, a separate and permanent watch is carried out by the researchers from the crow's nest. This is absolutely essential since even the most eager volunteers can sometimes be distracted or are simply not accustomed to scanning the horizon for splashes and flippers.

So as to avoid disturbing the cetaceans, approaches to groups always allow the animals to take the initiative. Onboard Toftevaag, very special emphasis is given to the respect not only of cetaceans but also to the global marine environment, this being the other major aim of the Alnitak association.

ADVANTAGES AND DISADVANTAGES The volunteer system has proved to be a very useful complement to the financing of a long-term research program. In addition, on the environmental education side we have found this system to be extremely valuable in many ways. On the other hand, on the scientific side, the effectiveness of volunteers is limited since they can only be assigned work that can be carried out with little training.

A risk we see to this type of work is that in areas with potential for commercial whale-watching, revealing the location of sighting areas can threaten cetacean populations if this develops with no strict controls. In our study area, this potential is not only very low, but also the lack of tourist development in the region reduces the risk.

**FALSE KILLER WHALE *PSEUDORCA CRASSIDENS* (OWEN 1846)
IN MALLORCA, BALEARIC ISLANDS (SPAIN)**

A. Castells and M. Mayo

Centro de Estudios de Mamíferos Marinos C/Velázquez 135,
28006 Madrid, Spain

In March of 1988, an adult false killer whale stranded in Colonia de San Pedro (Mallorca). Two pictures were sent to us by Xisco Avellá (Fondo para la Foca del Mediterráneo). The animal appeared to be in a very bad condition, with shark bites, partly skinned and with a rope tied to the caudal fin.

This record is very interesting because it is a species which rarely appears in Spanish waters. In the Mediterranean waters of Spain, we only have four other records of false killer whale, one in Marbella (1930) another in Palma de Mallorca (1943), and two sightings in the Strait of Gibraltar (1966 and 1989) - two groups each of 15 individuals. A further stranding, in Portugal and two in the Iberian Peninsula and Balearic Islands, are the only others recorded.

Nores and Perez (1982) also record the possibility of a massive stranding of 400-500 individuals on the Cantabrian coasts in 1795.

CETACEAN OCCURRENCE IN THE GULF OF LION AND SURROUNDINGS

A. Gannier *, P. Beaubrun** and N. Di-Méglio**

*Groupe de Recherche sur les Cétacés,
145 A1 route de Grasse, 06600 Antibes, France

**Ecole Pratique des Hautes Etudes, L.B.E.V.,
USTL, 34095 Montpellier cedex, France

INTRODUCTION In the recent past, much fieldwork has been dedicated to the northwestern Mediterranean Sea: the Liguro-provençal basin was highlighted because of its suspected richness, and various surveys give an idea of what is the summer abundance of two common species, the fin whale (*Balaenoptera physalus*) and the striped dolphin (*Stenella coeruleoalba*). We focus here on the nearby area, namely the Gulf of Lion and its surroundings, to determine whether it is comparable or not to the rest of the northwestern basin in terms of cetacean presence, both qualitatively and quantitatively.

The area of study extends from 41° N and 6° E to the continental coast (Figure 1), the total surface being about 61,000 km². Within the depth contours of 200 m - 2,000 m, the region may be divided into three sectors: the continental shelf wider than 50 kilometres (14,600 km²), the continental slope (16,000 km²) and the open sea (30,400 km²). The slope itself breaks in deep canyons, more or less perpendicular to its NE-SW axis.

Three hydrological features should be considered in that sector: the northern current moving off the slope from the Provençal basin to the Catalanian basin, the coastal upwellings frequently generated by strong north-westerlies, and the flowing of the Rhône River above the shelf southwards (Figure 7). Fresh northwest winds lead to a rather complicated situation with a strong counter current along the west coast and alternative advective movement deep in the canyons. Thanks to a series of recent sighting surveys, we are able to add new information about the distribution of cetaceans in this very specific maritime system.

MATERIALS AND METHODS We shall consider two types of data, covering late spring to early autumn for the period 1990 to 1993: the first set comes from oceanographic and fisheries research cruises and will be used for qualitative comparison only. A considerable, but not quantified, effort resulted in around 110 sightings of seven species. The second set comes from dedicated cruises undertaken during the summer of 1993 with our usual platform, a 9 metre sailship. The quantitative aspect will be dealt with using the latter data, because both platform and crew are used for line transect fieldwork in other Mediterranean sub-sectors (Gannier and Gannier, 1993). The density estimates are computed with the help of "Distance" software. The survey is conducted with two observers on the deck, and the boat cruising at five knots, exclusively with the use of diesel engine, and when the wind is weaker than Beaufort 3. Essential sighting parameters are measured with the help of a compass (sighting angle) and tele lens photography (distance is measured if greater than 200 metres); a closing of 15 minutes is permitted if necessary, for example to confirm a dubious sighting or to count individuals. Photo-identification of whales was not performed during that mission in order to save time. The quantitative study is based on 245 miles of effective effort in six days of good weather, during which 30 sightings of four species were recorded (Figure 4).

RESULTS AND DISCUSSION The qualitative results show a very clear correlation between topography and cetacean distribution: if we exclude a few sightings of bottlenose dolphins (*Tursiops truncatus*), the continental shelf appears to be almost deserted by cetaceans. That species is observed in groups not exceeding five animals (on one occasion) and quite far offshore. Striped dolphins and fin whales are occasionally sighted just inside the 200 metre contour, close to the heads of canyons. The continental slope is favoured by

the same two species as well as Risso's dolphin (*Grampus griseus*), particularly, the western canyons above which cetaceans seem to concentrate. These species are also met off the 2,000 metre depth contour. In this sub-sector, the sperm whale (*Physeter macrocephalus*) is regular and the long-finned pilot whale (*Globicephala melas*) is occasional, while the minke whale (*Balaenoptera acutorostrata*) has been observed once (Figures 4-6). The two pelagic sectors appear to shelter substantial quantities of animals in summer. Although, so far as we know, there is no dedicated fieldwork published, we found the same contrast between shelf and open sea for the Greenpeace/Barcelona University survey of 1991 (Forcada *et al.*, 1992).

If the rarity of pelagic animals seems to be logical above the shelf, one may be surprised by the apparent scarcity of bottlenose dolphins in that region, because of the presence of spawning phytophagous fishes, such as anchovies. On the other hand, we note an important discontinuity in the euphausiid distribution: indeed, almost all Mediterranean species are abundant offshore and none but a small form is found in the shelf region (Casanova, 1974). This would confirm a link between pelagic cetaceans and some euphausiid forms.

From a quantitative point of view, the encounter rates of striped dolphins are slightly inferior to those calculated in the liguro-provençal basin, weather permitting (Table 2). Because the difference is small, we have no reason to exclude the pelagic area of the Gulf of Lion from abundance estimates in the north western Mediterranean. The density and abundance of striped dolphins are evaluated for the summer 1993 (Table 3): they are compared for two strata, the Gulf of Lion (largely west) and the liguro-provençal basin (largely east). The detection function is modelled with 100 grouped sightings from the whole basin, as permitted by "Distance" software (Figure 2), and the detection parameters are summarised (Table 1).

A correction factor is then integrated to account for the relative speed between the animals and the ship: parameters entered are the speed ratio, and the aspect ratio (= length/width) of the rectangular detection area of the cetaceans. The correction factor is calculated for the average speed of a dolphin school - 3.5 knots - and various aspect ratios. Taking $\lambda = 2$, we find a density of 0.67 dolphin per km² with a CV of 24.5% for the offshore part of the Gulf of Lion, compared to 0.72 dolphin per km² with a CV of 19.5% for the liguro-provençal basin; the overall density is 0.70 dolphin per km² (CV=19%).

These estimates are higher than that of 0.43 found for the whole western Mediterranean by Forcada *et al.* (1992) and that of 0.42 published for the liguro-provençal basin by Notarbartolo di Sciara *et al.* (1993): but both results are given for an area including the shelf surface. Most authors agree that a major discontinuity in term of summer density exists between the south and the north of the western basin. Moreover, there is a major difference between the two hydrobiological situations, the north Balearic front acting as a moving frontier (Millot, 1987), and the euphausiid distribution shows a major shift between both areas, with the important role played in the north by *Meganctiphanes norvegica* (Casanova, 1974).

On the east-west axis, our preliminary results show no significant difference of dolphin density, if the sighting effort is considered to be sufficient. The major hydrological feature in the Ligurian basin is the frontal zone and it extends off the Gulf of Lion continental slope, but it is possibly active in the northern Balearic basin. If we take again the euphausiid distribution as a biological indicator, there is no major switch between east and west, even if *M. norvegica* apparently loses its undisputed dominance in the western pelagic area.

CONCLUSION Cetaceans are well represented in the offshore sector of the Gulf of Lion. Surprisingly, the bottlenose dolphin is not so common above the shelf, despite it being well known for the shoaling of several pelagic fishes. One may naturally ask if that

situation is historical or if the population has declined recently. Our quantitative results show no major difference between the offshore area of the Gulf of Lion and the better known liguro-provençal basin. More information is needed, particularly in the canyons region of the continental slope.

REFERENCES

- Casanova, B., 1974. *Les Euphausiacés de Méditerranée (Systématique et développement larvaire. Biogéographie et Biologie)*. Thèse de Doctorat ès Sciences Naturelles, Université d'Aix-Marseille I. CNRS A.O. 9 446, 360 pp.
- Gannier, A. and Gannier, O., 1993, Striped dolphin abundance in the Liguro-Provençal basin. Pp. 131-134. In *European Research on Cetaceans - 7*. Proc. of the 7th Annual Conference of the ECS, Inverness, Scotland, 18-21 February 1993. (Ed. P. G. H. Evans). European Cetacean Society, Cambridge, UK. 306 pp.
- Millot, C., 1987. Circulation in the Western Mediterranean Sea. *Oceanologica Acta*, 10(2): 143-149.
- Notarbartolo di Sciara, G., Forcada, J., Acquarone, M. and Fabbri, F., 1993, Population estimates of the fin whales and the striped dolphin summering in the Corso-Ligurian basin. Pp. 135-138. In *European Research on Cetaceans - 7*. Proc. of the 7th Annual Conference of the ECS, Inverness, Scotland, 18-21 February 1993. (Ed. P. G. H. Evans). European Cetacean Society, Cambridge, UK. 306 pp.

Table 1 Detection function parameters for *Stenella coeruleoalba*

	Parameter	Point Estimate	Standard Error	Percent Coef. of Variation	95 Percent Confidence Interval	
probability of sighting effective half width	f(0)	.23201E-02	.39822E-03	17.16	.16549E-02	.32528E-02
	p	.43101	.73979E-01	17.16	.30743	.60428
	ESW	431.01	73.979	17.16	307.43	604.28

Table 2 Comparison of encounter rates for the two strata of the northern Mediterranean Sea

	Parameter	Point Estimate	Standard Error	Percent Coef. of Variation	95 Percent Confidence Interval	
large ouest	n/L	.62500E-01	.81469E-02	13.04	.43590E-01	.89613E-01
large est	n/L	.74004E-01	.92329E-02	12.48	.56105E-01	.97613E-01

Table 3 Uncorrected density and abundance estimates for the two strata of the northern Mediterranean Sea

		Estimate	%CV	#	95% Confidence Interval	
large est school density	DS	.46354E-01	19.66	100	.31649E-01	.67893E-01
	D	.83794	19.51		.57368	1.2239
	N	51953.	19.51		35569.	75885.
large ouest school density	DS	.39149E-01	17.08	100	.28078E-01	.54585E-01
	D	.79695	24.54		.49613	1.2802
	N	34428.	24.54		21432.	55304.

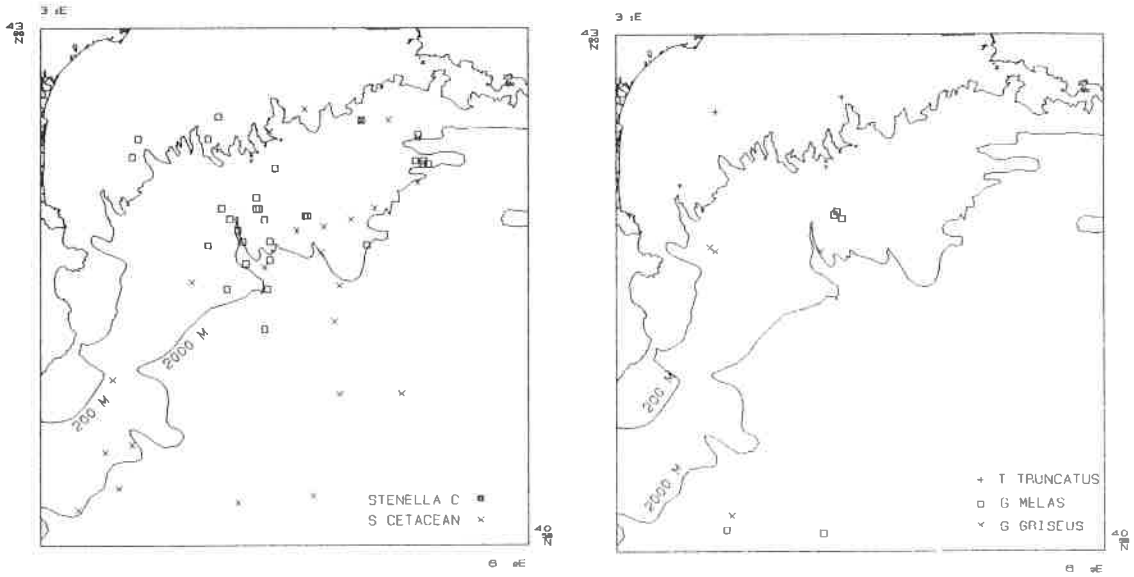

Figs. 1 & 2 Sightings of Small and Medium Cetaceans

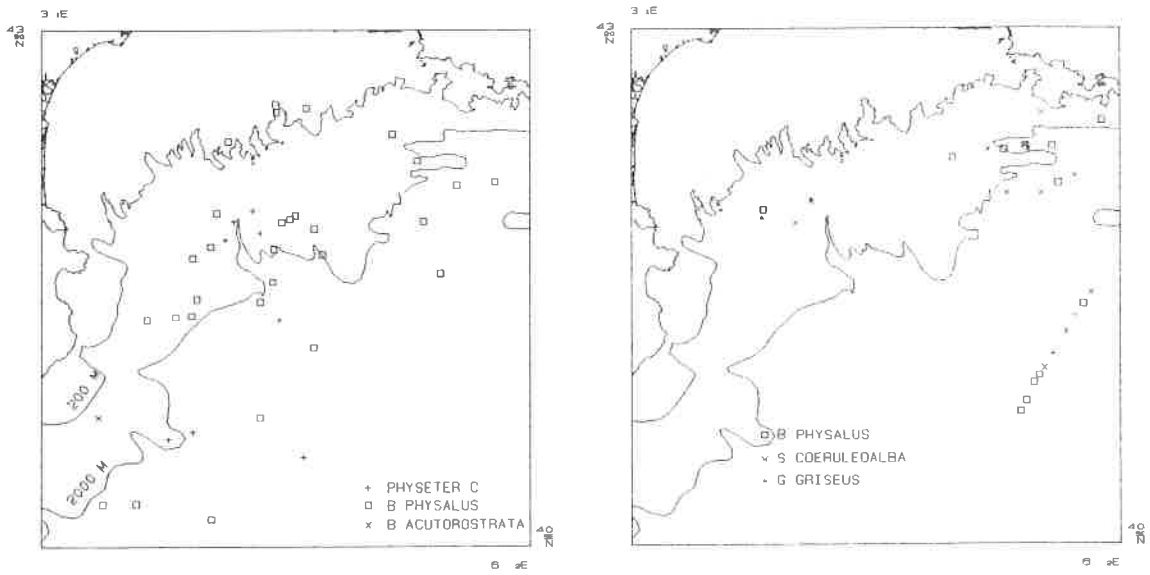

Figs. 3 & 4 Sightings of Large Cetaceans and Quantitative Data

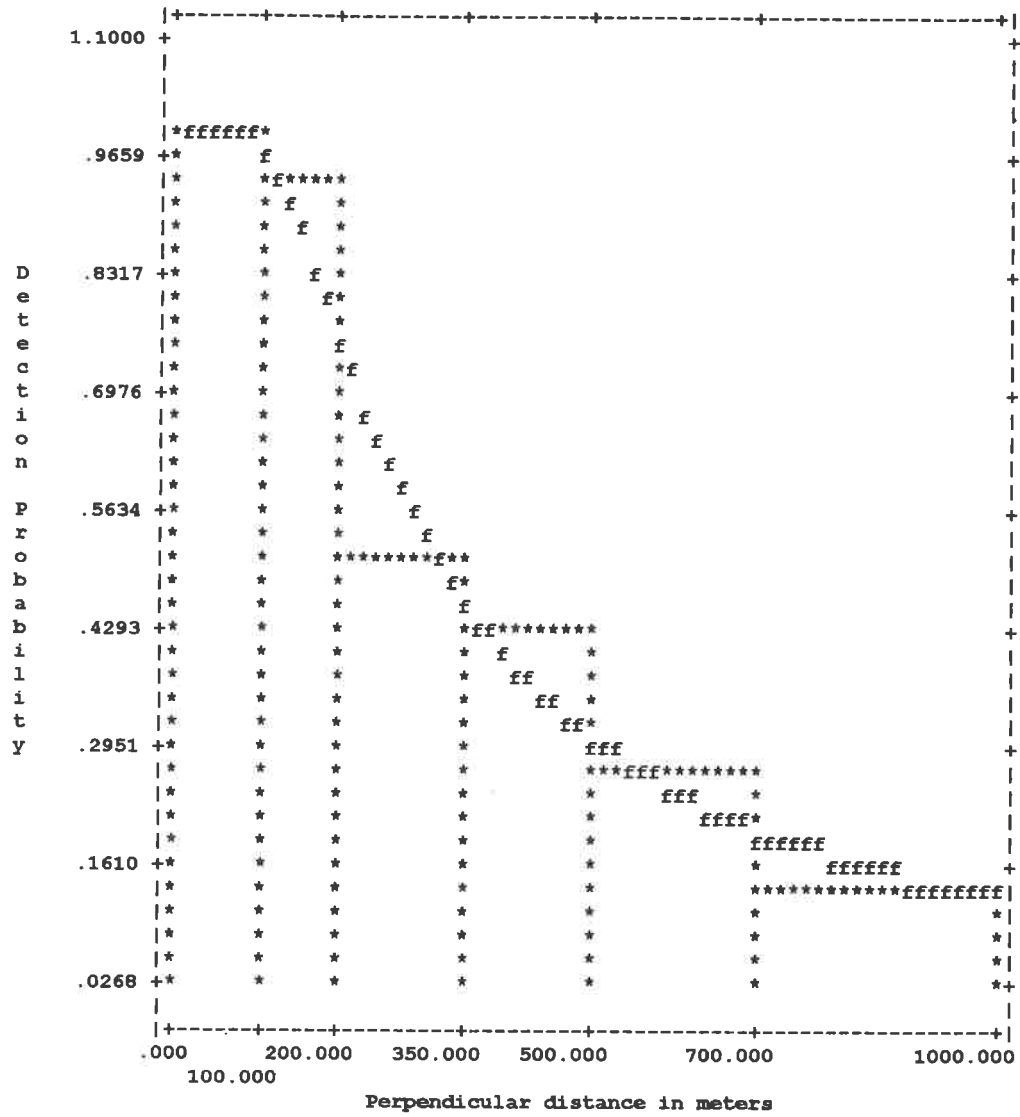

Fig. 5 Detection function and histogram of sightings of *Stenella coeruleoalba*, summer 1993

**ESTIMATION OF THE CORSICAN POPULATION
OF BOTTLENOSE DOLPHINS *TURSIOPS TRUNCATUS*:
IS THERE A REAL CONFLICT WITH FISHERMEN?**

J. M. Bompar, D. Baril, F. Dhermain and T. Ripoll.

G.E.C.E.M.,
Groupe d'Etude des Cétacés en Méditerranée
Maison de l'Environnement,
16 rue F. Fabre, 34000 Montpellier, France

INTRODUCTION Conflicts between fishermen and small cetaceans, especially the bottlenose dolphin (*Tursiops truncatus*) have been reported in many places.

In Corsica, this conflict has increased dramatically during the last two years during development of plans to establish a sanctuary in the Ligurian Sea. Fishermen have said that the population density of bottlenose dolphins has increased dramatically and they consider that the damage is no longer acceptable or sustainable. They have demanded population control and/or compensation.

Although the Corsican coast attracts many cetologists, no attempts have been made to estimate the bottlenose dolphin population, except in May 1994 when a count totalling 98 individuals was made (D. Viale, *pers. comm.*).

The GECCEM is often asked about the basis of this conflict and ways to solve it. In an attempt to provide answers, a study was planned with the support of WWF-France to (i) obtain an approximate estimation of population size; (ii) observe dolphin behaviour especially in relation to potential impacts on fishing operations; (iii) suggest ways of solving the fishermen-dolphin conflict. In 1993, we attempted to estimate the Corsican population of bottlenose dolphins and to find a way to address the other two questions.

MATERIALS AND METHODS In mid-August 1993, 10 to 12 observers were placed on two boats involved in a one week anticlockwise survey around Corsica. The sailboat travelled as directly as possible at a distance of 1.5 to 2 nm from the shore while the 6 metre long semi-inflatable covered the area between the coast and the track of the sailboat by alternating high speed movements of a few hundred metres with stops of a few minutes to make observations (Figure 1). The two teams were continuously in radio-contact and every boat in the surrounding area was asked about any encounters with dolphins.

Every time we encountered a pod of dolphins, the total number, the number of "young of the year", and behaviour were noted. Drawings of easily identifiable individuals were made and photographs were taken to avoid counting the same pod more than once and to initiate a photo-identification catalogue.

During our west Corsica study, weather conditions were excellent with Beaufort sea state 0 or 1 most of the time and we believe that a high percentage of animals present was detected. However, winds on the east coast made working conditions more difficult and the numbers of dolphins detected cannot be considered an accurate reflection of the number of animals present.

RESULTS On the east side of Corsica, we counted 25 - 36 bottlenose dolphins (of which one or two were young of the year) in three pods of 3 - 25 individuals.

On the west side of Corsica, we counted 102 - 118 bottlenose dolphins (of which six were young of the year) in seven pods of 3 - 30 individuals (Table 1).

No dolphins were observed interacting with fishing activities. However, swordfish and tuna were observed feeding a few metres from the coast and close to the nets.

DISCUSSION In our study, we found less than 120 individuals along approximately 250 km of coast and less than 6% of these were young of the year. These parameters are comparable with other studies (Scott *et al.*, 1990; Klinowska, 1991) and there is no evidence that the Corsican population of bottlenose dolphins shows signs of a very high density or a demographic explosion.

Fishermen claim that big holes in their nets are caused by dolphins. However, this damage could be caused by tuna, swordfish or dolphins, but perhaps most likely by modern motorised techniques to retrieve the net when it is caught on rocks. Furthermore, these same holes have been observed in places where fishermen never see dolphins.

On the other hand, dolphins could disturb fishing activities by frightening prey or by feeding directly on fish caught in nets. This possibility needs to be taken into account and one of our future studies will be to estimate impacts of bottlenose dolphins on fishing activities. For this, we propose to follow continuously one or two pods for a few days to estimate the size of their territories and the way that they exploit the local resources. At the same time, we will examine nets before and after dolphin encounters, and before and after net retrieval.

REFERENCES

- Klinowska, M. 1991. Bottlenose dolphin *Tursiops truncatus* (Montagu, 1821). Pp. 157-171. In *Dolphins, Porpoise and Whales of the World*. The IUCN Red Data Book. Gland, Cambridge, England. 429 pp.
- Scott, M. D., Wells, R. S. and Irvine, A. B. 1990. A long-term study of bottle-nosed dolphins in Florida. Pp. 78-80. In *European Research on Cetaceans - 4* (Eds. P.G.H. Evans, A. Aguilar & C. Smeenk). Proc. 4th Ann. Conf. ECS, Mallorca, 2-4 March, 1990. European Cetacean Society, Cambridge, England. 140 pp.

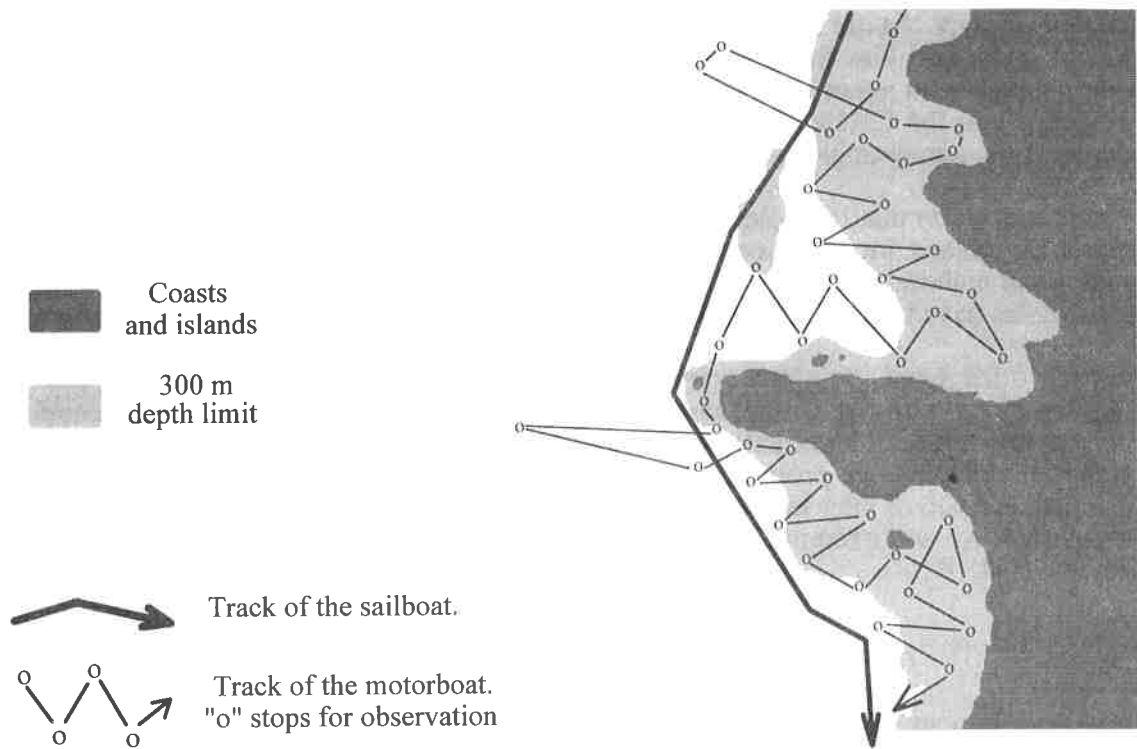

Fig. 1: Simulated example of the searching patterns of the two boats.

Date	15-08-93	16-08-93	17-08-93	19-08-93	22-08-93	22-08-93	23-08-93
from (GMT)	10:00	06:10	16:55	16:20	05:30	12:50	08:40
to (GMT)	10:10	10:40	18:00	18:00	06:15	13:20	08:50
Latitude (North)	42°59'80	42°46'00	42°14'20	41°43'50	41°33'00	41°24'00	41°21'40
Longitude (East)	9°17'00	9°09'40	8°32'05	8°37'50	8°46'00	9°04'00	9°18'75
Depth in meters	40	50	30	120	80	55	50
Minimum number	6	20	8	25	15	25	3
Maximum number	6	25	12	30	15	25	5
young of the year	0	2	0	0	2	2	0
Activities	<i>fishing</i>	<i>fishing</i> <i>game</i> <i>social</i>	<i>games</i> <i>mouving</i>	<i>mouving</i>	<i>mouving</i>	<i>mouving</i> <i>fishing</i>	<i>mouving</i>

Table 1: Observations on the west coast of Corsica.

STRIPED DOLPHIN HABITATS IN THE NORTHWESTERN MEDITERRANEAN

J. Forcada

Department of Animal and Plant Biology, Faculty of Biology,
University of Barcelona, 08028 Barcelona, Spain

The striped dolphin is the most abundant cetacean of the western Mediterranean. However, its distribution is heterogeneous according to geographic areas with different environmental factors. The northern fringe is characterised by vertical mixing and upwellings that create areas of high productivity.

In order to characterise the habitats more frequently used by striped dolphins in the northwestern Mediterranean, environmental data were collected in dedicated surveys. The area surveyed was divided into quadrats of 10' x 10' of latitude and longitude, for which differences in water depth, bottom contour and surface water temperature were examined. In general, dolphins were present in deep waters (Mean = 1,827m), with a relatively smooth topography and relatively cold waters (Mean = 23.13° C). However, areas with higher relative density and larger school size of dolphins were less deep than the average, with more irregular contours. Areas with dolphins showing feeding behaviour were cooler than the average.

ICONA funded this research.

STRIPED DOLPHIN ABUNDANCE IN THE NORTHWESTERN MEDITERRANEAN

J. Forcada*, A. Aguilar*, P. S. Hammond**, X. Pastor*** and R. Aguilar***

*Department of Animal Biology, Faculty of Biology,
University of Barcelona, 08028 Barcelona, Spain

**Sea Mammal Research Unit, N.E.R.C., Madingley Road,
Cambridge CB3 0ET, UK

***Greenpeace Mediterranean Sea Project, Ses Ràfaletes 13 1°,
07015 Palma de Mallorca, Spain

INTRODUCTION Increasing concern over cetacean populations in the Mediterranean Sea has led scientists and conservation organisations to put forward proposals directed to the protection of these seas. In open waters, these efforts have resulted in the protection of a large area of the Corso-Ligurian Sea. This precedent has reinforced the idea that other cetacean habitats in the north western Mediterranean may also deserve protection, but reliable information on the abundance and status of the cetacean populations inhabiting these areas is not currently available. In order to provide information to correctly evaluate these initiatives, line transect data obtained during a sightings survey carried out in the western Mediterranean by the University of Barcelona, the Sea Mammal Research Unit in Cambridge, and Greenpeace, in 1991, were analysed to produce an estimate of abundance of striped dolphins in the northern part of the basin.

METHODS The area considered in the present work includes the Balearic sea, the Provençal basin, and the Ligurian Sea (Figure 1). Methods used to produce estimates have been described by Forcada *et al.* (in press). These included fitting a Fourier series model with three adjustment terms to perpendicular distance data. Only primary sightings (those recorded whilst searching on effort) in Beaufort sea-state conditions between 0 and 3 were used for this analysis.

RESULTS Table 1 shows the density and abundance for each strata. Density of striped dolphins in the Balearic sea was lower than in the two areas and this difference is probably related to the physical characteristic of these water masses. The Liguro-Provençal basin is characterised by the presence of cool offshore waters, originating from the so called Mediterranean deep waters, and affected by strong and frequent north-west winds occurring in the area. These winds induce intense and complex currents that favour upwellings of deep waters rich in nutrients which support the growth of abundant food resources for dolphins. These cool offshore waters contrast with the warmer and poorer waters of the steady northern current which evolve cyclonically along the continental slope of the Liguro-Provençal basin to flow into the Balearic sea. Therefore, this last area is less productive, and cannot provide enough food resources to sustain a density of dolphins as high as in the other areas.

ACKNOWLEDGEMENTS Thanks are due to all the people who participated in the cruise. Màrius Tresàncez was of great assistance in the preparation of the software routines. ICONA funded participation of members of the University of Barcelona in this project.

REFERENCES

Forcada, J., Aguilar, A., Hammond, P., Pastor, X. and Aguilar, R. In press. Distribution and abundance of striped dolphins in the western Mediterranean after the 1990 epizootic outbreak. *Marine Mammal Science* 10(2):

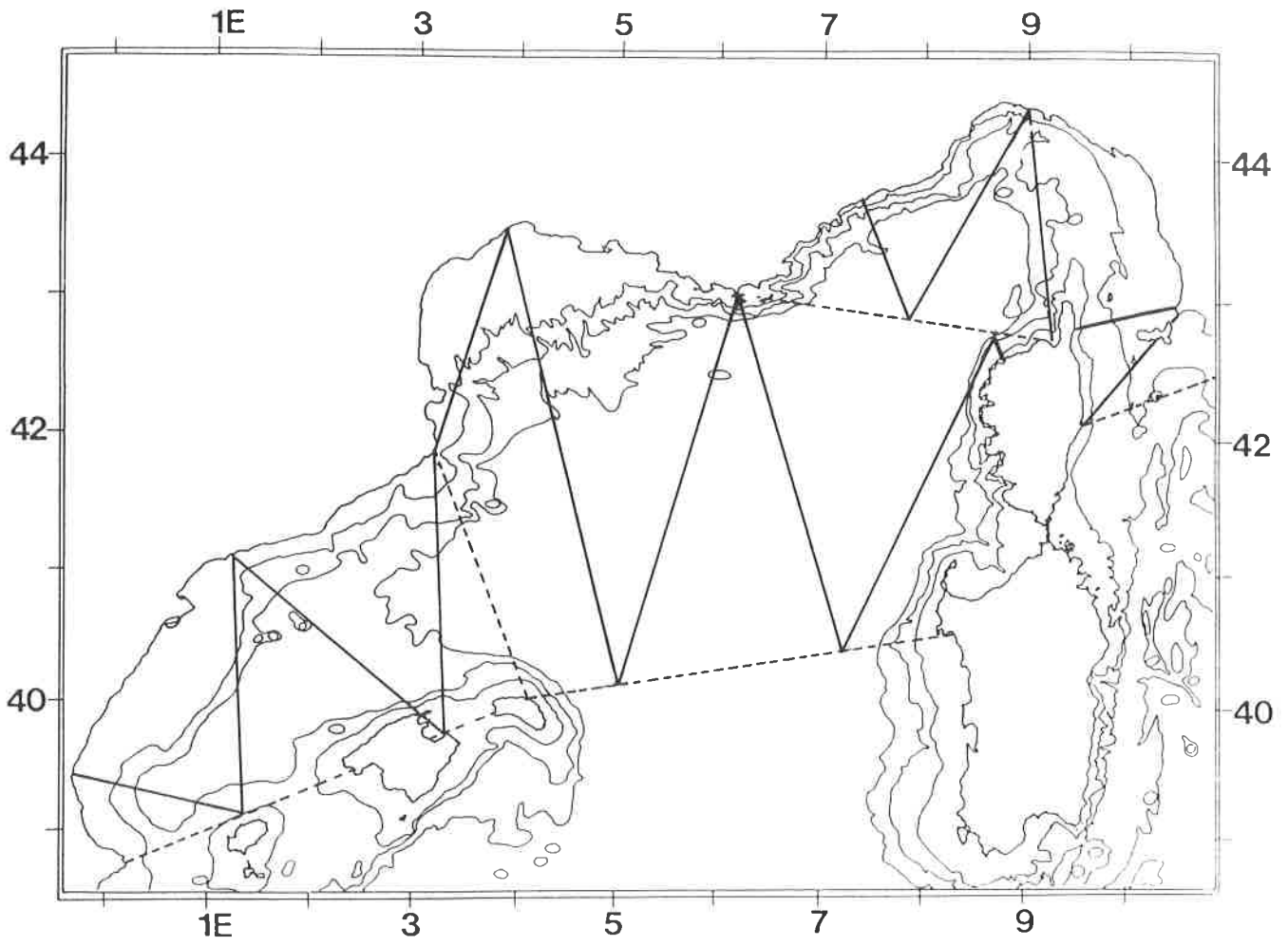

Fig. 1 Northwestern Mediterranean sea with cruise tracks

GEOGRAPHIC AREA	PARAMETER	POINT ESTIMATE + STD. ERROR	95% CONFIDENCE INTERVAL
BALEARIC SEA	DENSITY	0.0886 (0.0322)	0.0333 - 0.2353
	ABUNDANCE	5,826 (2,115)	2,193 - 15,476
PROVENÇAL BASIN	DENSITY	0.2296 (0.0574)	0.1301 - 0.4053
	ABUNDANCE	30,774 (7,700)	17,433 - 54,323
LIGURIAN SEA	DENSITY	0.3007 (0.1072)	0.1354 - 0.6679
	ABUNDANCE	14,003 (4,995)	6,305 - 31,101
NORTHWESTERN BASIN	DENSITY	0.2055 (0.0459)	0.1309 - 0.3227
	ABUNDANCE	50,634 (11,331)	32,254 - 79,488

Table 1 Density and abundance estimates of striped dolphins in the northwestern Mediterranean sea (densities are expressed as dolphins/km²)

ABUNDANCE OF *GRAMPUS GRISEUS* IN NORTHWESTERN MEDITERRANEAN

A. Gannier * and O. Gannier**

* Ecole Pratique des Hautes Etudes, Laboratoire de Biogéographie
et d'Ecologie des Vertébrés,
U.S.T.L. Montpellier 2, 34095 Montpellier, France

**Groupe de Recherche sur les Cétacés, 145 A1 route de Grasse, 06600 Antibes, France

INTRODUCTION Risso's dolphin (*Grampus griseus*) are regularly sighted in the Western Mediterranean, although they are less abundant than the dominant species, the striped dolphin (*Stenella coeruleoalba*). No abundance estimate has been made to date, because the species only accounts for a few percent in a typical open sea survey, such as those undertaken to evaluate the summer population of striped dolphins and fin whales (*Balaenoptera physalus*). Published sizes on their population are scarce, and do not come from a recognised estimation method: Viale (1977) gives a figure of 7,500 individuals for the northern half of the western Mediterranean basin, and the figure of "over 3,000 animals" in the whole Western Mediterranean is published in the report of the International Workshop on Mortality of Cetaceans (Perrin *et al.*, 1990). Nevertheless, an order of magnitude of a few thousands is likely to be true for the species in the northwestern basin. Other ecological data have indicated a tendency for the species to inhabit the continental slope in the area (Fabbri *et al.*, 1992). Our purpose is to give a preliminary estimate of its abundance with a line transect analysis of our six years of sightings data from the area.

MATERIALS AND METHODS From our six years and 850 sightings data bank, we have extracted 25 sightings of Risso's dolphins obtained in open sea with good weather conditions during 6,200 miles of effective effort (Figure 1). We will focus on the area north of the 41° N latitude, including the northern Tyrrhenian sea and excluding the continental shelves, whose surface is 143,000 km². The species shows no marked seasonal change of frequency in the area, at least if we consider the Ligurian sub-sector where most of our winter survey takes place: in this preliminary study, that parameter will not be examined.

For the same platform and observers and under given sea conditions, the detection curve of a standard group of Risso's dolphin may be considered as unique; hence a detection function is processed by "Distance" with a set of 25 sightings. A first estimate of density and abundance is made for the surface of the study area off the 500 metres depth contour. Histograms of the depths and distances of sightings to the 500 metres contour give ecological information that leads to a second estimate with a stratification into the two geographical sectors.

RESULTS AND DISCUSSION A sample of 25 sightings is actually minimal for the purpose of modelling a detection function: Buckland *et al.* (1993) consider 30 data points to be the bottom limit for a preliminary evaluation of $f(0)$. Nevertheless, with appropriate intervals and upper truncation of 700 m, "Distance" gives a parameter $f(0)$ of $0.286 \cdot 10^{-2}$ with a CV of 10% (Figure 4).

Surprisingly, the effective search half-width (esw) of 350 m is not far from that of a smaller species like striped dolphin, as evaluated from data obtained with the same platform and crew (Gannier and Gannier, 1993). This could be explained by the fact that Risso's dolphin is generally less conspicuous than striped dolphin, and school sizes of this species are commonly much smaller; moreover, our striped dolphin detection functions have been modelled for summer data only, hence with better visibility. The mean school size is around 8.3 individuals, but once we have corrected for a positive distance correlation, it

becomes 6.9 individuals. School size is difficult to evaluate when a group of animals is engaged in active feeding.

The density estimate of $0.179 \cdot 10^{-1}$ individual per km^2 is hampered by a high CV of 37.2%, thus leading to a very wide confidence interval for the abundance estimate of 2,860 individuals (Table 1). This apparently arises from the sampling variance (CV = 28.5%) and school size variance (CV = 21.7%).

As shown in the histograms of depth and distance (Figures 2 and 3), Risso's dolphins in the area have a marked preference for the continental slopes, even if a few groups were sighted in open sea. This is confirmed by the bimodal distribution of the distances: 81% of the sightings are within ten miles of that line, 12% are between 10 and 15 miles, and the remaining 12% are greater than 50 miles. This was also recognised by Fabbri *et al.* (1992): in a data set of 55 sightings (from three sources), only 20% of the groups were spotted off the 2,000 metres contour.

From these ecological observations, we decided to stratify the samples into two parts: those belonging to the continental slope (between 500 and 2000 m depth) and those belonging to the open sea. The geographical strata have respective surface areas of 53, 500 and 89, 500 km^2 . The analysis leads to a density of $0.417 \cdot 10^{-1}$ animals per km^2 for the slope and $0.145 \cdot 10^{-2}$ for the open sea, with respectively CV's of 35.7 and 102%. Although the latter value denotes the lack of significance for the open sea stratum, which is caused by a low sample size (Table 2b), the results confirm the marked difference in frequency of both strata, in terms of density. The stratification also results in an abundance of 2,230 individuals (CV= 35.7%) for the continental slope stratum (Table 2a).

The main component of the population effectively appears to frequent the continental slope, where it is supposed to feed on its favourite cephalopods; observation indicates active searching of prey with long duration dives, or resting and socialising. Stomach contents of stranded individuals give repeated evidence of a teuthophageous diet with a preference for small-sized cephalopods such as histioteuthids (Bello, 1992). It is supposed that Risso's dolphins are able to exploit the entire water column near the continental slope, including the nerito-benthic area (Carlini *et al.*, 1992).

The other component of the population has been observed on transit, at least on two occasions, with a distinct direction of travel and a constant swimming speed. This may suggest that groups travel from one feeding place to another, not only by following the slope, but also in a straight line. This would also suggest a pre-determined destination.

CONCLUSION Although hampered by a high coefficient of variation, the proposed estimate comes from controlled data and a known analytical technique: 2,360 individuals appears to be the most probable figure for the northwestern Mediterranean Sea. Excluding the shelf data to compute a rough estimate is obviously a stopgap measure, which we felt was necessary because Risso's dolphin often come within a few miles of the overcrowded coastal zone, and are threatened by fishing gears and other human activities. The question of the abundance of this species clearly deserves a dedicated survey effort, and we intend to conduct this in the coming year.

REFERENCES

- Viale, D. 1977. *Ecologie des cétacés en Méditerranée Nord Occidentale: leur place dans l'écosystème, leur réaction à la pollution marine par les métaux*, Thèse d'état, Université Pierre et Marie Curie, Paris VI. 312 pp.
- Perrin, W. F. (editor) 1990. Report of the Workshop on mortality of Cetaceans in passive fishing nets and traps. SC/43/Rep 1 (La Jolla, USA). Unpublished report.

Fabrizi, F., Giordano, A. and Lauriano, G. 1992. A preliminary investigation into the relationship between the distribution of Risso's dolphin and depth. Pp. 146-151. In *European Research on Cetaceans - 6* (Ed. P.G.H. Evans). Proc. 6th Conf. ECS, San Remo, Italy, 20-22 February 1992. European Cetacean Society, Cambridge.

Buckland, S. T., Anderson, D. R., Burnham, K. P. and Laake, J. L. 1993. *Distance sampling*. Chapman and Hall, London. 446 pp.

Bello G., 1992. Stomach contents of a Risso's dolphin, *Grampus griseus*. Do dolphins compete with fishermen and swordfish? Pp. 199-202. In *European Research on Cetaceans - 6* (Ed. P.G.H. Evans). Proc. 6th Conf. ECS, San Remo, Italy, 20-22 February 1992. European Cetacean Society, Cambridge.

Carlini R., Pulcini M. and Würtz M., 1992. Cephalopods from the stomachs of Risso's dolphins, *Grampus griseus*, stranded along the central Tyrrhenian coast. Pp. 196-198. In *European Research on Cetaceans - 6* (Ed. P.G.H. Evans). Proc. 6th Conf. ECS, San Remo, Italy, 20-22 February 1992. European Cetacean Society, Cambridge.

Table 1a Estimates for the open sea stratum

Parameter	Point Estimate	Standard Error	Percent Coef. of Variation	95 Percent Confidence Interval	
f(0)	.28573E-02	.28649E-03	10.03	.23220E-02	.35159E-02
p	.49998	.50132E-01	10.03	.40632	.61523
ESW	349.99	35.092	10.03	284.42	430.66
n/L	.78740E-02	.20898E-02	26.54	.38164E-02	.16246E-01
DS	.60740E-02	.17233E-02	28.37	.29703E-02	.12421E-01
E(S)	6.8620	1.4863	21.66	4.3957	10.712
D	.41680E-01	.14877E-01	35.69	.19598E-01	.88641E-01
N	2230.0	795.98	35.69	1049.0	4742.0

Table 1b Estimates for the continental slope stratum

Parameter	Point Estimate	Standard Error	Percent Coef. of Variation	95 Percent Confidence Interval	
n/L	.27473E-03	.27473E-03	100.00	.53730E-04	.14047E-02
DS	.21192E-03	.21298E-03	100.50	.37460E-04	.11989E-02
E(S)	6.8620	1.4863	21.66	4.3957	10.712
D	.14542E-02	.14951E-02	102.81	.25673E-03	.82371E-02
N	130.00	133.65	102.81	23.000	737.00

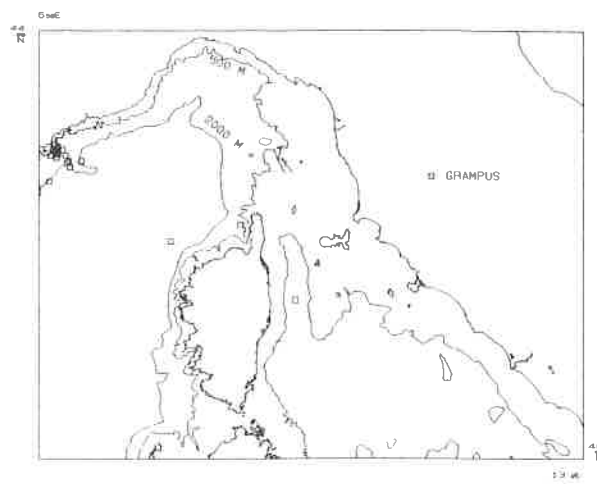
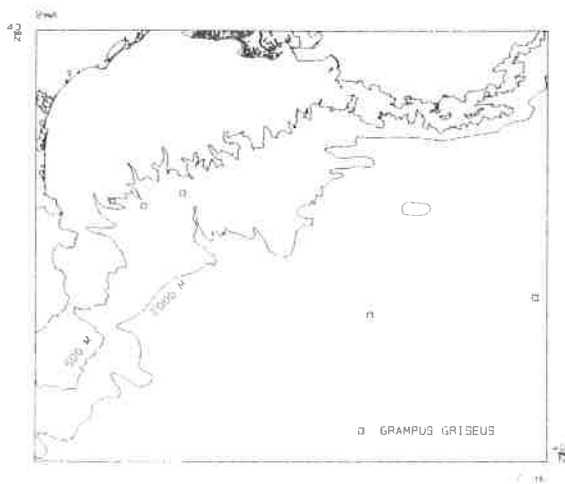

Fig. 1 Area of study and position of sightings

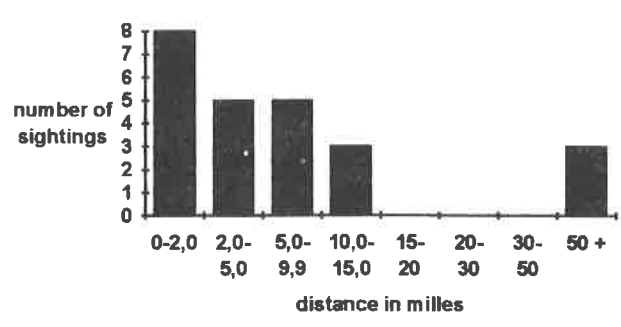
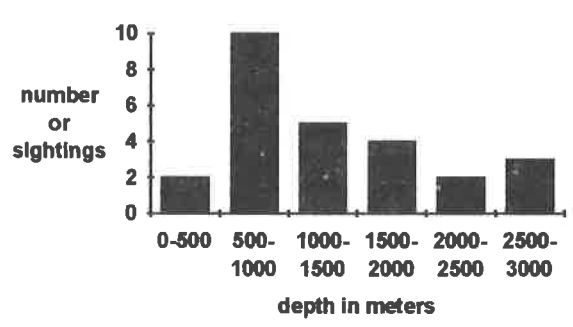

Fig. 2 Distribution of depths

Fig. 3 Distance to the 500 m contour

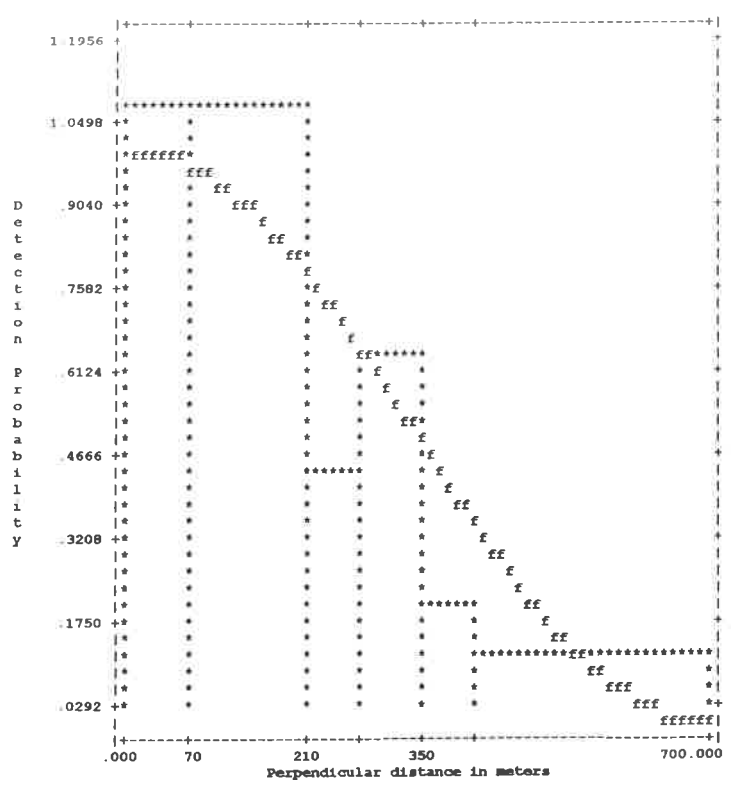

Fig. 4 Detection function estimated by Distance

**DISTRIBUTION AND EVALUATION OF CETACEANS
IN THE ALBORAN SEA (S.E. MEDITERRANEAN)**

I. Franco* and J. Mas**

*Instituto Espagnol de Oceanografia, Malaga, Spain

**Instituto Espagnol de Oceanografia, Mercia, Spain

From 8 to 27 July 1993, a cetacean survey cruise took place between 6°12'00" W and 29°30'00" W in the Alboran sea and Gibraltar Strait waters.

The R/V Francisco de Paula navarro covered 1,288 miles with 127 observation hours during the IEO ICTIO ALBORAN-0793 cruise.

59 sightings were made in all, with six species of cetaceans recognised: common dolphin (*Delphinus delphis*), bottlenose dolphin (*Tursiops truncatus*), striped dolphin (*Stenella coeruleoalba*), long-finned pilot whale (*Globicephala melas*), Risso's dolphin (*Grampus griseus*), and sperm whale (*Physeter macrocephalus*).

Distribution maps for the more common species (*Delphinus delphis*, *Tursiops truncatus*, *Stenella coeruleoalba*, *Globicephala melas*) are shown along with an estimate of their population sizes. Some data on the behaviour are also presented.

CETACEANS IN ALGERIAN COASTAL WATERS

Z. Boutiba

Institut des Sciences de la Nature, Université d'Oran,
BP 1524, 31000 Algerié

INTRODUCTION The cetacean fauna frequenting the Algerian waters has remained little known until recently. In view of the growing interest in information regarding marine mammals around the world, it appears useful to try to prepare an inventory of the species frequenting the Algerian coast. This paper presents a review and synthesis of the information so far obtained.

MATERIALS AND METHODS From January 1974 to December 1993, thanks to a network of volunteer observers, 286 animals (some captured, others stranded) have been counted, of which 146 have been specifically identified. In addition, a further 140 animals, both stranded and captured, have been collected by ourselves.

Sightings at sea have been helped by a wide range of observers recording in a standardised manner (CIESM, 1989).

A total of 337 observations were made over a zone lying between the longitude of Ghazaouet (2°3' W) near to the Moroccan border and the longitude of El-Kala (8°38' E) a few kilometres from the Tunisian border, and from the Algerian coast to the 38th parallel (Fig. 1; see also Boutiba, 1989, 1992; Boutiba and Bouderbala, 1993). This information is furnished by research ships (ISMAL and Greenpeace) and merchant seamen operating between Algiers and France. We have added our own observations to the observations made at sites along the coast and at sea.

RESULTS In total, eight species of cetaceans (seven odontocetes and one mysticete) have been identified in Algerian waters (see Table 1).

DISCUSSION AND CONCLUSIONS The great whales, sperm whale (*Physeter macrocephalus*), fin whale (*Balaenoptera physalus*) and Cuvier's beaked whale (*Ziphius cavirostris*) are very rare (representing only 1.7, 3.9, and 1.4% respectively of the total number) compared with the Delphinoidea which constitutes more than three-quarters of the total. Among the species of this family:

- three are common: common dolphin (*Delphinus delphis*), bottlenose dolphin (*Tursiops truncatus*) and striped dolphin (*Stenella coeruleoalba*);
- two are less frequent: long-finned pilot whale (*Globicephala melas*) and Risso's dolphin (*Grampus griseus*).

With 41.3% of the stranded animals and 44% of live sightings, the common dolphin appears to be the most frequently recorded species in the region.

With very similar frequencies (32.5% and 33% respectively) of strandings and live sightings at sea, the bottlenose dolphin is the most commonly recorded species after common dolphin in the area.

Striped dolphin (14% of strandings and 12.2% of sightings) are less frequently encountered than common dolphin and bottlenose dolphin.

Long-finned pilot whale (3.2% of strandings and 3.5% of sightings) and Risso's dolphin (1.4% of strandings and 2% of sightings) were less frequently recorded while Cuvier's beaked whale and sperm whale, according to our data, are quite rare in the Algerian basin.

A highly diverse cetacean fauna is shown to be present all along the Algerian coast where the various species benefit from the enrichment of Algerian waters by Atlantic currents and the comparatively warm surface temperature through all seasons.

REFERENCES

Boutiba, Z. 1989. Répartition et fréquence des échouages des cétacés sur le littoral ouest algérien. Comm. Sémin. Nat. Sc. et Techn. de la mer. Février 1989, Algeria. 8pp.

Boutiba, Z. 1992. *Les mammifères marins d'Algérie. Statut, répartition, écologie, biologie*. Thèse Doctorat ès Sciences, Université d'Oran. 575pp.

Boutiba, Z. and Bouderbala, M. 1993. Teneurs en métaux lourds chez les cétacés fréquentant la côte ouest algérienne. Etude préliminaire. Pp. 205-213. In *Water Circulation and Pollution in the Maghrebian Coast of the Mediterranean Sea*. Eds INOC, Izmir, Turkey.

C.I.E.S.M. 1989. Fiche d'observation en mer des Cétacés de Méditerranée occidentale. Unpubl. Report. 2pp.

Table 1 Number of animals stranded, captured and observed at sea between 1974 and 1993

Species	Stranded & captured		Observed		Total	
	n	%	n	%	n	%
<i>Delphinus delphis</i>	118	41.3	149	44	267	42.8
<i>Tursiops truncatus</i>	93	32.5	111	33	204	32.7
<i>Stenella coeruleoalba</i>	40	14	41	12.2	81	13
<i>Globicephala melaena</i>	9	3.2	12	3.5	21	3.4
<i>Grampus griseus</i>	4	1.4	7	2	11	1.8
<i>Ziphius cavirostris</i>	6	2	2	0.6	8	1.3
<i>Physeter macrocephalus</i>	5	1.7	5	1.5	10	1.6
<i>Balaenoptera physalus</i>	11	3.8	10	2.9	21	3.3
Total	286	100	337	100	623	100

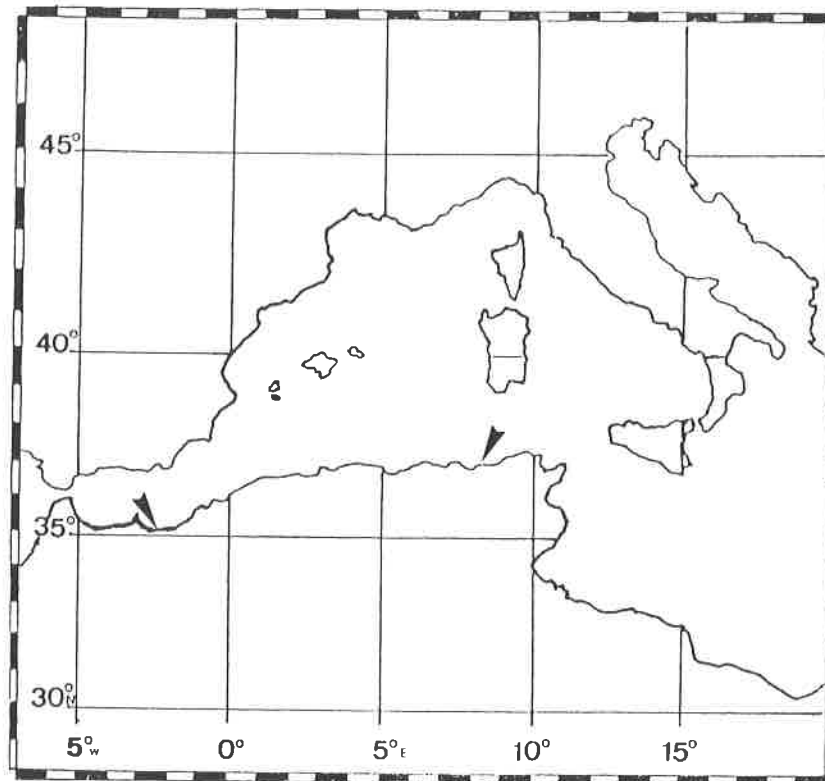

Fig. 1 Region of coverage for stranded, captured and rescued cetaceans along the Algerian coast (limits marked by arrows)

STATUS OF CETACEANS IN TUNISIAN MARINE WATERS

F. Chakroun

INAT, 43 Avenue Charles Nicolle, 1082 Tunis, Tunisia

This study reports the strandings and accidental catches of cetaceans occurring along Tunisian coasts.

Since 1937, 11 species have been recorded. nine of them have been accurately identified They are: fin whale (*Balaenoptera physalus*,) minke whale (*Balaenoptera acutorostrata*) sperm whale (*Physeter macrocephalus*,) bottlenose dolphin (*Tursiops truncatus*), common dolphin (*Delphinus delphis*), striped dolphin (*Stenella coeruleoalba*), long-finned pilot whale (*Globicephala melas*), killer whale (*Orcinus orca*), and humpback whale (*Megaptera novaeangliae*).

The presence of sei whale (*Balaenoptera borealis*) and harbour porpoise (*Phocoena phocoena*) is doubtful.

The humpback whale was noticed for the first time in the Eastern Mediterranean sea in the Gulf of Gabès.

In spite of the lack of studies on biology and ecology, it seems that mortality caused by human activities has increased during the last few years.

Because of the damage caused by bottlenose dolphin (*Tursiops truncatus*) on fisheries, a system producing artificial sounds was established in order to disperse these dolphins from fishing areas.

The result seems to be satisfactory and it can be used efficiently to protect these animals.

A CETACEAN SURVEY IN THE AEGEAN SEA: WORK IN PROGRESS

Paolo Carpentieri, Luca Marini and Carlo Consiglio

Dipartimento di Biologia Animale e dell'Uomo,
Università di Roma "La Sapienza",
viale dell'Università 32, 00185 Roma, Italy

Research on cetaceans in the Mediterranean Sea has not yet given a complete description of their ecology and biology.

In particular, the presence of cetaceans in the Aegean Sea has not been examined thoroughly. Our present knowledge in this area comes from some sighting surveys (Fabbri, 1990; Topaloglu *et al.*, 1989), but mostly from the analysis of strandings (Marchessaux and Duguy, 1979; Marchessaux, 1980).

The aim of this survey was to obtain a better "picture" of the presence of cetaceans in the Aegean Sea.

The research was carried out from May to September 1993 aboard commercial ferries and the ship belonging to the Institute of Marine Biology of Crete (I.M.B.C.). Counts and observations were made directly most of the time, utilising also binoculars and a camera.

During the five months of study, 94 trips were carried out, sailing on 39 different routes, mainly among the Cyclades and Dodecanese Islands (Fig. 1), for a total sightings effort of 365 hours, and 52 sightings (Fig. 2).

Bottlenose dolphin (*Tursiops truncatus*) and striped dolphin (*Stenella coeruleoalba*) have been the most common species (Fig. 3). Bottlenose dolphin was observed mainly along the north-eastern coast of Crete and the eastern coast of Karpathos island, while striped dolphin was recorded mainly south of Santorini island, only twice being recorded near the islands of Rodhos and Karpathos.

Risso's dolphin (*Grampus griseus*) was observed for the first time in the Aegean Sea: two out of the three recorded sightings concerned schools of 7-8 individuals and the third was of two animals.

Sightings of sperm whale (*Physeter macrocephalus*), *Balaenoptera* sp. and Cuvier's beaked whale (*Ziphius cavirostris*) have been reported as rare. Surprisingly, common dolphin (*Delphinus delphis*) was never recorded.

Moreover, in the same period, interviews were made to obtain information about strandings of cetaceans and interactions between marine mammals and fisheries (damage made to the nets and catches).

This research will be carried out more extensively in summer 1994.

ACKNOWLEDGEMENTS We wish to thank all the people who have helped us in this survey, the University of Crete, the Institute of Marine Biology of Crete especially Prof. A. Eleftheriou and Dr. A. Kallianiotis, and the crew of the ship "Phylia". Particular thanks go to B. Catalano from the University of Rome "La Sapienza", for her help in the research and in preparing this paper.

REFERENCES

Fabbri, F. 1990. Operazione cetacei 1990. Greenpeace Italia. Unpublished report. 44 pp.

Marchessaux D. and Duguy, R. 1979. Note préliminaire sur les cétacés de la Méditerranée orientale. Rapp. Comm. int. Mer Médit., 25/26(10): 147-149.

Marchessaux D., 1980. A review of the current knowledge of the cetaceans in the Eastern Mediterranean Sea. Vie mar., 2: 59-64.

Topaloglu B., B. Ozturk and A. Colak, 1990. Species of dolphins that occur in the western Black Sea, the Sea of Marmara and the Aegean Sea. Rapp. Comm. int. Mer Médit., 32(1): 238.

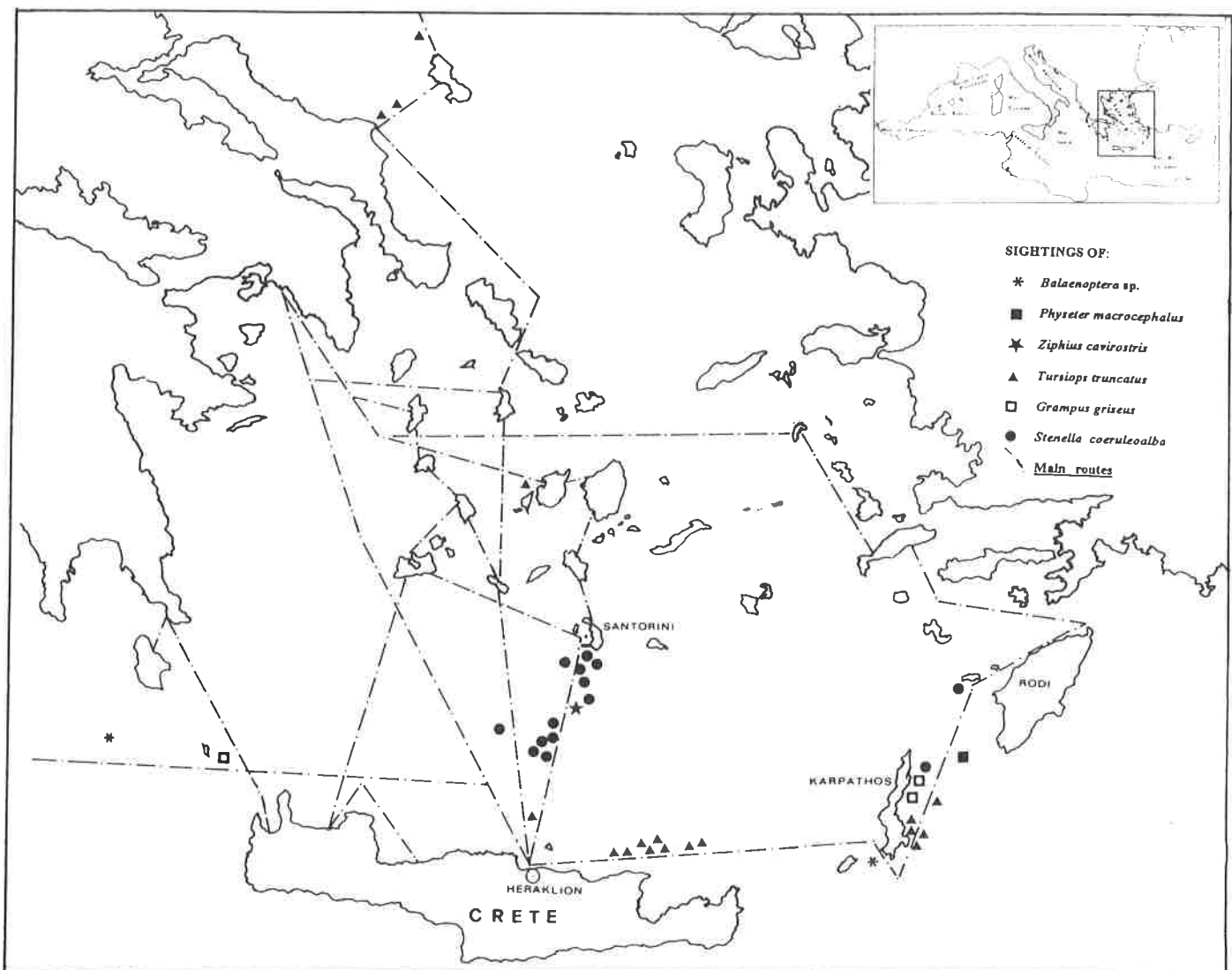

Fig. 1 Map showing cruise tracks and cetacean sightings

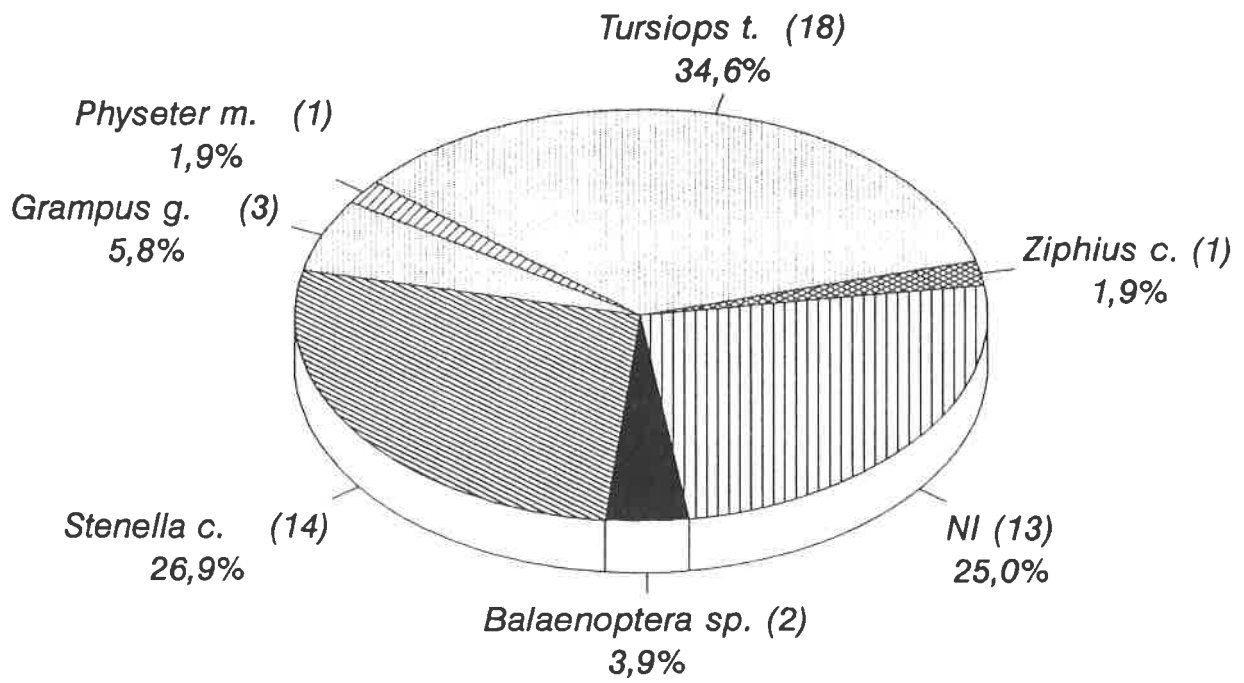

Fig. 2 Sightings numbers and percentages for each cetacean species

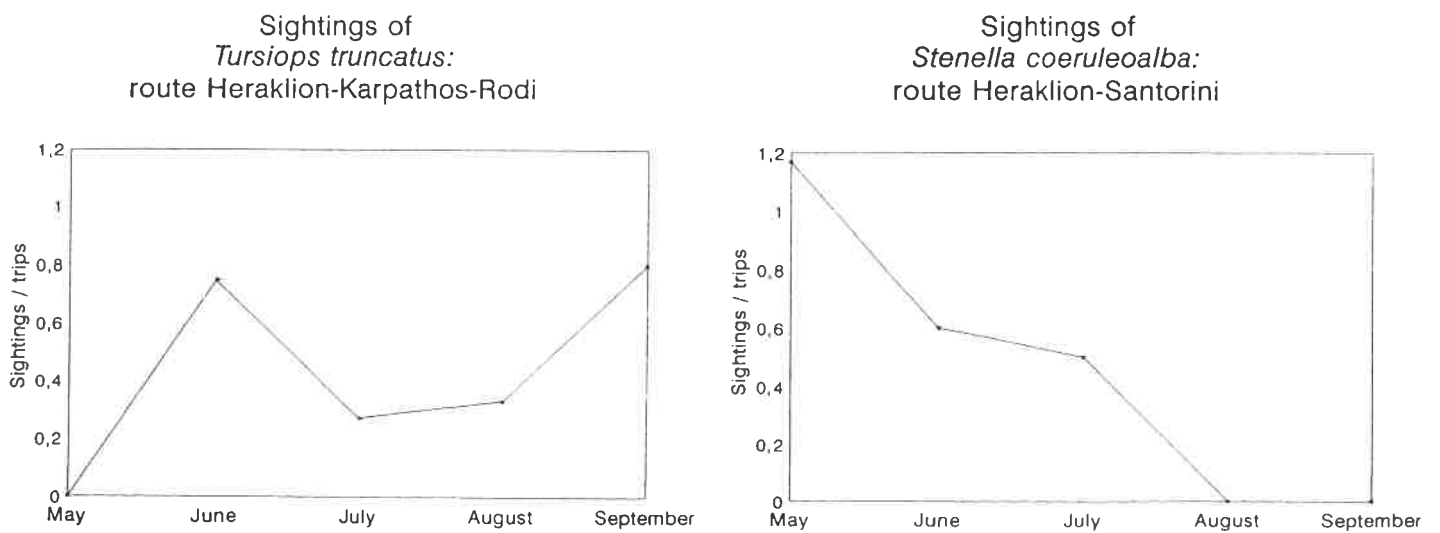

Fig. 3 Seasonal changes in sightings frequency of bottlenose dolphin and striped dolphin

A PRELIMINARY STUDY OF THE ECOLOGY OF CETACEANS IN THE WATERS ADJACENT TO GREEK IONIAN ISLANDS

E. Politi, S. Airoidi, and G. Notarbartolo di Sciara

Tethys Research Institute, Via G. Giusti, 5, 20154 Milano, Italy

INTRODUCTION Research cruises aboard a 15 metre long sailing vessel, to record distribution, group size and ecology of cetaceans, were conducted in the Greek Ionian islands during summer, from 1991 to 1993. In 1991, the research consisted of a preliminary reconnaissance of the cetacean fauna in those waters (Politi *et al.*, 1992). During that study it was apparent that different cetacean species were found within a limited geographic range; furthermore, the predictable presence in a restricted coastal area of a community of common dolphins (*Delphinus delphis*), sharing the same habitat with bottlenose dolphins (*Tursiops truncatus*), was particularly intriguing. On the basis of those observations, during subsequent years, research efforts were particularly focused on the coastal region (labelled in this study B and D), where common and bottlenose dolphins were found to coexist. On that occasion, a first attempt at photo-identifying common dolphins was made, which yielded a remarkably high re-sighting rate.

MATERIALS AND METHODS Research cruises took place in 1991 and 1992 from July to September, and in 1993 from June through September. The platform used was a 15 metre long sailing boat, equipped with GPS, cruising at an average speed of four knots. Latitudinal limits of the study area were 40°05'N and 38°21'N (Fig. 1, inset). In order to describe the differences in the distribution of cetaceans, the entire study area was post-stratified into four subareas (A, B, C, D, Fig. 1). Areas A (the Otranto Channel) and C are typically offshore, while B and D are inshore, but with different topographic features. In areas A and C only opportunistic observations were performed during transfers. For this reason, the emphasis of the study was in areas B and D. Observation sessions were carried out by at least one trained observer on each side of the boat during daylight. Position, distance from the nearest coast, water depth and estimated group size were recorded at each sighting and stored in a database.

For calculations of sighting frequencies, data were discarded when wind speed exceeded two on the Beaufort scale. Photo-identification of common dolphins was carried out only during summer 1993, while in the previous two years only opportunistic photographs were taken, and therefore used solely to determine re-sightings. The camera used was a Minolta 7000i AF with a Minolta 100-300 mm f. 4.5 lens, and Ektachrome EPR 64 ISO, Fujichrome RVP 50 ISO, and Kodak EPD 200 ISO colour transparency films. Identification of common dolphins was based on natural marks such as nicks, notches and the white patch on the dorsal fin. Although the size and shape of the white patch appeared to be changing with age in the earlier stages of life, we ascertained by comparing adult individuals seen in different years, that the white patch is a useful identification character. Analyses were performed mostly on natural logarithmic transformed data, in order to meet the assumptions for parametric tests (Zar, 1984). ANOVA and Student's t tests were used; where the sample size was too small, a non-parametric Mann-Whitney U test was preferred.

RESULTS

- (1) The time spent in the study areas with good weather conditions is shown in Table 1.
- (2) Results showed no significant differences in sighting frequencies between areas A and C (Student's t test on ln transformed data: $t = 1.069$, $p > 0.05$), and so the two areas were pooled together.
- (3) Mean search times for areas A+C, B and D were respectively 357 min (SE = 53.0, n = 26), 2,241 min (SE = 458.4, n = 14), and 461 min (SE = 76.9, n = 45). Area B was shown to be the poorest in cetacean sighting frequencies ($F = 10.89$, $df = 2$, $p < 0.001$).

(4) The distribution of cetaceans in the three areas was as follows:

Areas A and C: Fin whales (*Balaenoptera physalus*) (mean search time = 1134 min, SE = 392.9, n = 8), striped dolphins (*Stenella coeruleoalba*) (mean search time = 571 min, SE = 114.2, n = 16) and Cuvier's beaked whales (*Ziphius cavirostris*) (mean search time = 2,845 min, SE = 2,842.6, n = 2) were seen. No differences were found between sighting frequencies of fin whales and striped dolphins (Mann-Whitney U = 38, df = 8,16, $p > 0.05$).

Area B: The bottlenose dolphin was the only species sighted in this area, with a mean time of search of 2,413 min (SE = 491.3, n = 13). This value is not different from that found in area D for the same species (Student's $t = 0.32$, df = 20, $p > 0.05$, performed on natural log transformed data).

Area D: Common dolphins (mean search time = 579 min, SE = 118.2, n = 36) were more abundant than bottlenose dolphins (mean search time = 2,267 min, SE = 495.3, n = 9), as shown by a Student's test performed on natural log transformed data ($t = 3.44$, df = 43, $p < 0.01$).

5) The largest groups were recorded for striped (mean size = 18, SE = 3.5, n = 32) and common dolphins (mean size = 13, SE = 1.7, n = 37), while bottlenose dolphins (mean size = 6, SE = 1.0, n = 27), fin whales (mean size = 3, SE = 0.5, n = 7) and Cuvier's beaked whales (mean size = 2, SE = 0.7, n = 3) had smaller herds ($F = 8.47$, df = 4, $p < 0.001$). Mean group sizes of bottlenose dolphins in both areas, B and D, did not differ (Student's $t = 1.15$, df = 25, $p < 0.05$, performed on natural log transformed data).

6) Inshore sightings. Results showed no differences in distance from the coast ($t = 1.65$, df = 45, $p > 0.05$) and water depth ($t = 0.69$, df = 45, $p > 0.05$) between common and bottlenose dolphins (the latter were tested only on data available from area D) (Table 3). By contrast, bottlenose dolphins from areas B and D presented different ecological parameters: in area D they were found closer to the coast (Mann-Whitney U = 30, df = 17,10, $p < 0.05$) and in deeper waters (Mann-Whitney U = 39.5, df = 17,10, $p < 0.05$) than in area B.

7) Photo-identification was conducted during 1993 in area D only, on common dolphins; we observed 19 groups for a total of 260 dolphins encountered. Forty-five individuals were identified and 27 of them were re-sighted during the study (sighting frequency for identified animals ranged from one to seven days). Ten individuals photo-identified in 1993 were photographed also in 1991 and 1992.

DISCUSSION The lowest overall sighting frequencies were recorded in area B, while areas A+C and D showed similar abundance of cetaceans. Bottlenose dolphins did not seem to be very abundant in either area B or D.

The largest groups were of striped and common dolphins; mean group size for these species were smaller than in other parts of the Mediterranean Sea (Notarbartolo di Sciara *et al.*, 1993). On the other hand, bottlenose dolphins had a mean group size consistent with the values recorded elsewhere in the Mediterranean (Bearzi, 1993). Data concerning group size of fin whales and Cuvier's beaked whale were too scarce to allow comparisons.

Fin whales, striped dolphins, and Cuvier's beaked whales confirmed their pelagic preferences.

Areas B and D are characterised by a different topography: area B largely includes a flat seafloor less than 100 m deep; area D presents a wider array of bottom reliefs, and water depth increases abruptly near the coast. Our results confirm the ecological adaptability of bottlenose dolphins (Shane, 1990), found in both areas and therefore with different characteristics (Table 3). By contrast, common dolphins were only sighted in area D, confirming the preference by this species for an uneven bottom described elsewhere (e.g. Hui, 1979). Although the common dolphin is known to span from coastal to pelagic waters (Heyning and Perrin, 1991; Gaskin, 1992) and in some regions is distributed in inshore areas (Evans, 1971; Forcada *et al.*, 1990; Findlay *et al.*, 1992), it is noteworthy that in this area common dolphins were even more coastal than bottlenose dolphins.

- Photo-identification was used as the first step in an attempt to assess group composition and site fidelity in common dolphins. The high number of photo-identified and re-sighted

animals is indicative of a small population size and a high degree of fidelity within the area investigated. Moreover, the recognition of photo-identified individuals from the opportunistic photos taken in years 1991 and 1992 demonstrate that both notches and the white patch on the dorsal fin in adult individuals can be considered as permanent marks (Würsig and Jefferson, 1990), and therefore used as identification characters.

This study may have interesting implications concerning the conservation of Mediterranean populations of common and bottlenose dolphins. We suggest that in future, a detailed investigation be conducted on these dolphin species, which co-exist in a variety of habitats concentrated within a limited geographic range.

ACKNOWLEDGEMENTS This research was funded by Europe Conservation and by the paying volunteers who participated in the cruises. We wish to thank all of them, as well as the crew of the "De Gomera", the sailing boat on which the research was conducted. Special thanks go to Matteo Curti, Andrea Salerno and Nicoletta Ancona, who have contributed photographs for the common dolphin photo-identification catalogue.

REFERENCES

- Bearzi, G., Notarbartolo di Sciara, G., Politi, E., and Lauriano, G. 1993. Social ecology and behavior of bottlenose dolphins in the waters adjacent to the island of Losinj (Croatia). Abstracts of Tenth Biennial Conference on the Biology of Marine Mammals, Galveston, Texas.
- Evans, W.E. 1971. Orientation behavior of delphinids: radio telemetric studies. *Ann. N.Y. Acad. Sci.*, 188: 142-160.
- Forcada, J., Aguilar, A., Evans, P. G. H., and Perrin, W. F. 1990. Distribution of common and striped dolphins in the temperate waters of the Eastern North Atlantic. Pp. 64-66. In *European Research on Cetaceans - 4* (Eds. P.G.H. Evans, A. Aguilar and C. Smeenk). Proc. 4th Ann. Conf. ECS, 2-4 March 1990, Palma de Mallorca. European Cetacean Society, Cambridge, UK.
- Gaskin, D. E. 1992. Status of the common dolphin, *Delphinus delphis*, in Canada. *Can. Field Nat.*, 106(1): 55-63.
- Heyning, J. E. and Perrin, W. F. 1991. Re-examination of two forms of common dolphins (genus *Delphinus*) from the Eastern North Pacific; evidence for two species. NOAA Admin. Rep. LJ-91-28. 53 pp.
- Hui, C. A. 1979. Undersea topography and distribution of common dolphins of the genus *Delphinus* in the Southern California Bight. *J. Mamm.*, 60(3): 521-527.
- Notarbartolo di Sciara, G., Venturino, M. C., Zanardelli, M., Bearzi, G., Borsani, F. J., and Cavalloni, B. 1993. Cetaceans in the central Mediterranean Sea: distribution and sighting frequencies. *Boll. Zool.*, 60: 131-138.
- Politi, E., Bearzi, M., Notarbartolo di Sciara, G., Cussino, E., and Gnone G. 1992. Distribution and frequency of cetaceans in the waters adjacent to the Greek Ionian Islands. Pp. 75-78. In *European Research on Cetaceans - 6* (Ed. P.G.H. Evans). Proc. 6th Ann. Conf. ECS, 20-22 February 1992, San Remo, Italy. European Cetacean Society, Cambridge, UK.
- Shane, S. H. 1990. Behavior and ecology of the bottlenose dolphin at Sanibel Island, Florida. In *The bottlenose dolphin* (Eds. S. Leatherwood and R.R. Reeves). Academic Press. 653 pp.
- Würsig, B. and Jefferson, T. A. 1990. Methods of photo-identification for small cetaceans. *Rep. Int. Whal. Commn. (Special Issue 12)*: 43-52.
- Zar, J. H. 1984. *Biostatistical analysis*. 2nd Ed. Prentice-Hall, Englewood Cliffs, New Jersey. 718 pp.

AREA	1991	1992	1993	91-93
A	2317' (38h 37')	1098' (18h 18')	267' (4h 27')	3682' (61h 22')
B	13228' (220h 28')	8386' (139h 46')	9548' (159h 8')	31162' (519h 22')
C	2033' (33h 53')	2120' (35h 20')	1734' (28h 54')	5887' (98h 7')
D	2928' (48h 48')	8372' (139h 32')	9685' (161h 25')	20985' (349h 45')
TOTAL	20506' (341h 46')	19976' (332h 56')	21234' (353h 54')	61716' (1028h 36')

Table 1 Time spent in the field during good weather conditions (wind < 2 Beaufort), divided in the four subareas.

Species	Distance from the nearest coast (km)			Water depth (m)		
	mean	se	n	mean	se	n
Bp	15.8	2.31	9	624	70.8	9
Sc	17.5	1.54	32	678	42.7	32
Zc	11.1	3.84	3	685	128.7	3

Table 2 Summary statistics for the offshore species.
 Bp= *Balaenoptera physalus*,
 Sc= *Stenella coeruleoalba*,
 Zc= *Ziphius cavirostris*.

Species	Distance from the nearest coast (km)			Water depth (m)		
	mean	se	n	mean	se	n
Dd	1.4	0.19	37	107	11.5	37
Tt(D)	2.1	0.37	10	125	24.6	10
Tt(B)	4.5	0.54	17	68	7.2	17

Table 3 Summary statistics for inshore species. Dd= *Delphinus delphis*,
 Tt(D)= *Tursiops truncatus* in area D, Tt(B)= *T. truncatus* in area B.

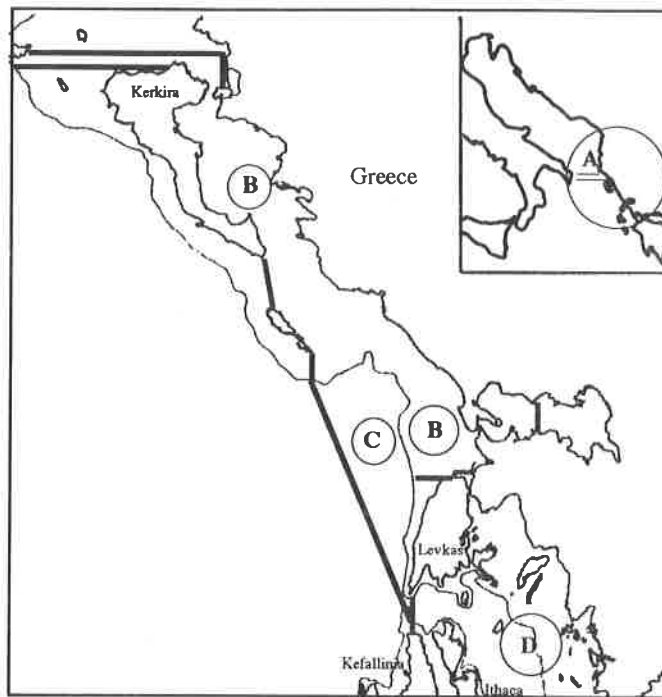

Fig. 1: The entire study area was post-stratified in four subareas: A = offshore (Channel of Otranto); B = inshore, northern of $38^{\circ}47'17\text{N}$; C = offshore, D = inshore, southern of $38^{\circ}47'17\text{N}$. Areas B and C are separated by the 200 m bathymetric contour.

OBSERVATIONS OF CUVIER'S BEAKED WHALE *ZIPHIUS CAVIROSTRIS* (CETACEA, ODONTOCETI) IN THE IONIAN ISLANDS OF GREECE

M. Pulcini *, ** and A. M. Angradi **

* Musea civico di Zoologia, Rome, Italy

**Ambiente Mare, Via Vitellia 15/b,
00152 Rome, Italy

INTRODUCTION The family Ziphiidae comprises 18 species. Among them, only Cuvier's beaked whale (*Ziphius cavirostris*, G. Cuvier, 1823), and Blainville's beaked whale (*Mesoplodon densirostris*, de Blainville, 1817) are present in the Mediterranean Sea. Cuvier's beaked whale is one of the better known beaked whales and has been seen in groups of up to 25 animals but usually occurs in tight schools of 3-10 individuals (Evans, 1987).

The presence of Blainville's beaked whale in the Mediterranean Sea is considered accidental (Cagnolaro *et al.*, 1986) and has been reported in the literature only by Casinos (1982).

Little is known about the biology of Cuvier's beaked whale in the Mediterranean Sea. According to Viale (1981), this species is gregarious, strictly teuthophagous and prefers frontal zones, where contact between two water masses generally produces an enrichment of animal biomass.

Strandings along the Italian coast of the central Mediterranean Sea have been reported by Vinciguerra (1926), Tamino (1957), Tortonese (1957, 1963), and more recently by Cagnolaro *et al.* (1986) and Centro Studi Cetacei (1987, 1988, 1989, 1990 and 1991). Other records have been reported by Cagnolaro (1965), Di Natale (1983), Marini *et al.* (1992), and Oliver (1991).

MATERIALS AND METHODS The campaign on the cetaceans of the Ionian Islands of Greece, during which the sightings referred to here occurred, and which is still in progress, consists of four months of transects, using a 16 metre long vessel, among the islands of Corfù, Paxos, Cephalonia, Lefkas and Dragonera.

During the research, the sighted specimens were recognised with the help of 10x50 binoculars and photographed with 35 mm cameras equipped with auto winder and 100 and 300 mm lenses. 64 ASA, 100 ASA, and 200 ASA slides were employed. A video camera Sony VHS was also employed.

At each sighting, the following information was recorded: the position, time of observation, estimated distance of the cetaceans, their cruising speed, direction of travel, number and behaviour; and general sea-meteorological conditions.

RESULTS Three cetaceans were sighted on 23 June, 1993, at 13.45 hrs, about 600 metres from the boat, while it was sailing towards P. Fiskardo (Isle of Cephalonia). The position was 038°46'40"N, 020°26'93"E, above a bottom of about 900 m., and they were 8 miles away from the Isle of Lefkas.

They had massive, light brown, nearly amber-coloured bodies. The three animals jumped 6-7 times, without having a definite direction. Four dives were observed, averaging from 5 to 10 minutes. The sighting lasted about 20 minutes, before the animals went down. The state of the sea was about 1; the wind was blowing from the north-west.

The other three Cuvier's beaked whales were sighted on the 19 July, at 14.20 hrs, above a bottom of about 800 m. The position was 038°52'60"N, 020°23'43"E, at a distance of 12 miles from the coast.

The specimens were not close and were noted for their great dives. The sea and the wind were calm, but the visibility was not perfect. We tried to approach, but they dived. The sighting lasted about two minutes.

Four specimens of Cuvier's beaked whale were sighted on 3 August at 10.17 hrs, above a bottom of about 1,000 m. The position was 038°52'23"N, 020°18'98"E. The animals were 15 miles away from Lefkas.

The specimens were observed owing to their leaps; they made great splashes on the water with 27-45 second dives. Some other dolphins probably accompanied the Cuvier's beaked whales.

A pair of cetaceans was sighted on 17 August, at 12.40 hrs, above a bottom of about 1,000 m, seven miles from the coast of Lefkas. The position was 038°43'86"N, 020°25'77"E. The visibility was good; the sea and wind were calm.

One individual was juvenile, black coloured, about five metres in length, its dorsal fin small and slightly falcated. The other animal was an adult, with a massive, light brown, nearly amber-coloured body. Its dorsal fin, lying in the posterior third of the body, was small and triangular, with particular cuts. Linear light scars were observed on its back and sides.

The pair were swimming towards the boat, as far as 10-15 metres from it. They travelled in a SSW direction. They made ten short, regular dives always followed by a 10-15 minute dive, with proceeding compensation. 60 slides were shot with 100-300 mm lens and a 25 minute sequence with the video camera was recorded. The sighting lasted 35 minutes.

The last sighting refers to three specimens on the 1st September at 14.28 hrs. The position was 038°44'82"N, 020°25'49"E above a bottom of about 1,000 m, six miles from the Isle of Lefkas. The sea was calm, and the visibility good.

Two animals were adult, one juvenile, and all of them black-brown coloured. The three specimens were travelling south-east. They dived three times with 15-18 minutes long dives.

CONCLUSION The morphology of the specimens and their behaviour coincided completely with the description by Cagnolaro *et al.* (1986) for Cuvier's beaked whale.

The beaked whales are species particularly of deep waters; they feed at great depths, probably often on the sea bottom where their flexible almost toothless beaks may be adapted for the capture of agile prey, such as squid (Evans, 1987).

As for the difference between sexes in this species, it was established only in the fourth sighting where the two specimens were recognised as a female with her calf.

It is notable that all the sightings occurred in a small area of sea near the islands of Lefkas and Cephalonia, where there is a steep escarpment (Fig. 1).

Cuvier's beaked whale is known to dive very deep and for a very long time. In fact, all the prey species found in the stomachs of Cuvier's beaked whales in the Mediterranean sea are oceanic and midwater animals (cf. Podesta and Meotti, 1991). They live offshore above the continental slope or associated with sea mounts (Carlini *et al.*, 1992; Marini *et al.*, 1992).

REFERENCES

- Cagnolaro, L. 1965. Osservazioni su di un giovanissimo *Ziphius cavirostris* G. Cuv., arento sia Genova il 20 aprile 1964 (Cetacea, Ziphiidae). Atti Soc. it. Sci. nat. Museo civ. Storia nat. Milano, 104 (4): 377-382.
- Cagnolaro, L., Cozzi, B., Magnaghi, L., Podesta, M., Poggi, R. and Tangerini, P. 1986. Su 18 cetacei spiaggiati sulle coste italiane dal 1981 al 1985. Rilevamento biometrico ed osservazioni necroscopiche. Atti Soc. it. Sci. nat. Museo civ. Storia nat. Milano, 127 (1-2): 79-106.
- Carlini, R., Pulcini, M. and Wurtz, M. 1992. Cephalopods from the stomachs of a Cuvier's beaked Whale (*Ziphius cavirostris*, Cuvier, 1823) stranded at Fiumicino, Central Tyrrhenian Sea. Pp. 190-191. In *European Research on Cetaceans - 6* (Ed. P.G.H. Evans). Proc. 6th Ann. Conf. ECS, 20-22 February 1992, San Remo, Italy. European Cetacean Society, Cambridge, UK.
- Casinos, A. 1982. Los Cetaceos del Mediterraneo. Mundo Cientifico, 16: 714-724.
- Centro Studi Cetacei. 1987. Cetacei spiaggiati lungo le coste italiane. I Rendiconto 1986. Atti Soc. It. Sci. Nat. Mus. Civ. Stor. Nat. Milano, 128 (3-4): 305-313.
- Centro Studi Cetacei. 1988. Cetacei spiaggiati lungo le coste italiane. II Rendiconto 1987. Atti Soc. It. Sci. Nat. Mus. Civ. Stor. Nat. Milano, 129 (4): 411-432.
- Centro Studi Cetacei. 1989. Cetacei spiaggiati lungo le coste italiane. III Rendiconto 1988. Atti Soc. It. Sci. Nat. Mus. Civ. Stor. Nat. Milano, 130 (21): 269-287.
- Centro Studi Cetacei. 1990. Cetacei spiaggiati lungo le coste italiane. IV Rendiconto 1989. Atti Soc. It. Sci. Nat. Mus. Civ. Stor. Nat. Milano, 131 (27): 413-432.
- Centro Studi Cetacei. 1991. Cetacei spiaggiati lungo le coste italiane. V Rendiconto 1990. Atti Soc. It. Sci. Nat. Mus. Civ. Stor. Nat. Milano, 132 (25): 337-355.
- Di Natale, A. 1983. Goosebeaked Whale, *Ziphius cavirostris*, and Rough-toothed dolphin, *Steno bredanensis*, in the Italian Seas. Rapp. comm. int. Mer Médit., 28 (5).
- Evans, P.G.H. 1987. *The Natural History of Whales and Dolphins*. Christopher Helm / Academic Press, London. 343pp.
- Marini, L., Consiglio, C., Angradi, A.M. and Sanna, A. 1992. Sighting of four Ziphiidae in the Central Tyrrhenian Sea. *Hystrix*, 4 (1): 85-89.
- Oliver, G. 1991. Occurrence of *Grampus griseus* and *Ziphius cavirostris* on the coast of Roussillon (France). *Ann. Soc. Sci. Nat. Charenie-Marti*, 7: 1049-1052.
- Podesta, M. and Meotti, C. 1991. The stomach contents of a *Ziphius cavirostris* and a *Grampus griseus* stranded in Italy. Pp. 58-61. In *European Research on Cetaceans - 5* (Ed. P.G.H. Evans). Proc. 5th Ann. Conf. ECS, 21-23 February 1991, Sandefjord, Norway. European Cetacean Society, Cambridge, UK.
- Tamino, G. 1957. Il cetaceo odontocete *Ziphius cavirostris* G.Cuv. presso il Lido di Fregene (Roma) il giorno 9-III-1957. Atti Soc. It. Sci. Nat. Mus. Civ. Stor. Nat. Milano, 96: 203-210.
- Tortonese, E. 1957. Il cetaceo odontocete *Ziphius cavirostris* G.Cuv. nel Golfo di Genova. *Doriana*, Genova, 2 (71): 1-7.
- Tortonese, E. 1957. Insolita comparsa di cetacei (*Ziphius cavirostris* G.Cuv.) nel Golfo di Genova. *Natura*, Milano, 54: 120-122.
- Viale, D. 1981. Ecology of the Cetaceans in the Western Mediterranean Sea. *Mammals in the Seas*, 3: 287-300.
- Vinciguerra, D. 1926. Due rari cetacei in Liguria (*Ziphius cavirostris* G. Cuv. e *Pseudorca crassidens*, Owen). *Annali Mus. Civ. Storia Nat. Genova*, 52: 232-235.

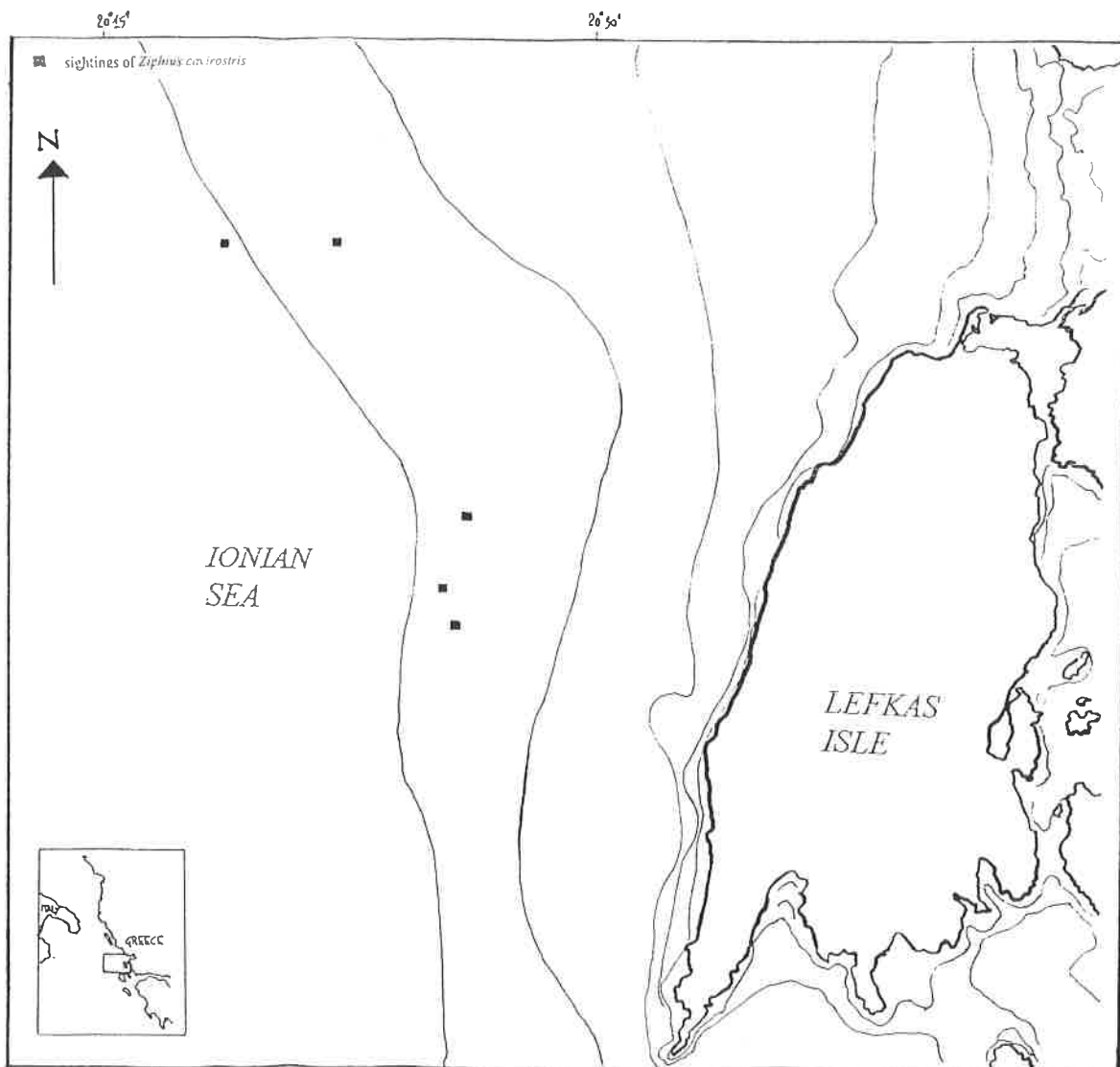

Fig. 1 Map showing sightings of *Ziphius cavirostris* around the Ionian island of Greece

PROSPECTIVE OF CETOLOGY IN CROATIA

Drasko Holcer

F. Ogulinca 27, 44000 Sisak, Croatia

Cetology in Croatia started to develop as a science in the middle end of the nineteenth century. At that time, a few Croatian authors (Kolombatovic, 1882; 1885; 1894; 1896; Kotic, 1892) tried to establish which cetacean species represent the fauna of the Adriatic. One of the best and most comprehensive reviews of all known data at that time for the whole Adriatic sea was Brusina's (1889) "Mammals of the Adriatic sea". However, considerable work was also done in cetacean palaeontology (Gorjanovic-Kramberger, 1884; 1892), when *Champsodelphis carniolicus*, *Platanista croatica* and *Mesocetus agrami* were described. After that time, interest in cetology started to fade, and several authors only reported certain interesting cases, like the appearance of false killer whale *Pseudorca crassidens*, long-finned pilot whale (*Globicephala melas*) and northern bottlenose whale (*Hyperoodon ampullatus*) in the Adriatic sea (Hirtz, 1921; 1922; 1931; 1933).

In the 1950s, dolphins were considered as the worst enemies and a strong campaign for their extermination was launched. Fishermen were encouraged to kill dolphins with premiums paid for each animal killed, and organisations were given guns to shoot dolphins whenever possible. To give some indication of the scale, in 1956 and 1957, the deaths of 239 dolphins were reported from just one part of the Croatian coast (Crnkovic, 1958). The campaign lasted for at least ten years. Worst of all, during that time killings were reported only when the premium was paid, and there are no statistical data on numbers and species killed.

In the 1980s, the Group for Endangered Animals of the Croatian Biological Society launched a campaign for the protection of marine mammals. Over a few years they have collected information on sightings of Mediterranean monk seals and cetaceans in the Adriatic. The Mediterranean monk seal was protected at that time and considerable sensitisation of the public occurred, but cetaceans were forgotten again. Lack of finances stopped the campaign.

Because all work is characterised by a lack of constancy and of a systematic approach, and the majority of data are generally published in magazines that have little to do with cetology or are produced solely by journalists, it should not be a surprise that to date, cetaceans in the Croatian part of the Adriatic have not been protected. In fact, they are not even mentioned by any law!

Some regular studies over the last ten years concerning the distribution of dolphins and the gathering of strandings data from the Croatian part of the Adriatic was carried out by the Veterinary Faculty, University of Zagreb. They recently submitted a proposal for the protection of cetaceans in the Croatian part of the Adriatic Sea to the Department of Nature Protection of Ministry of Civil Engineering and Nature Protection. The answer is still expected.

Up to now, all work done can be considered as zoological. Fieldwork and work concerning the ecology and biology of cetacean species is constantly lacking. Changes and a new approach were made by Tethys Research Institute from Milano, whose researchers started to carry out a year-round field study of the socio-ecology of a community of bottlenose dolphins in the area of Losinj and Cres in the Northern Adriatic (Bearzi *et al.*, 1991; Bearzi & Notarbartolo di Sciarra, 1993). This is the first study of that type and has aroused a lot of interest in Croatia.

In future, work on ecology and behaviour of Adriatic dolphins will be continued, and will be accompanied by the establishment of a network for the monitoring of strandings. At first, the network will be organised in the Northern Adriatic. Furthermore, a campaign for the protection of all cetaceans will be launched in order to assist the acceptance of the present proposal, but also to have an educational goal. Since most of the people interested in cetology are still students, the activities that can be performed are not very wide, but they represent determination to work in the field of cetology. The support and help from Tethys Institute is great, but it is also necessary to expand our connection and cooperation with other cetologists too.

REFERENCES

- Bearzi, G., Notarbartolo di Sciara, G. and Bonomi, L. 1991. *Bottlenose dolphins of Croatia: a socio-ecological study*. Tethys Research Institute, Milano, 10 pp.
- Bearzi, G. and Notarbartolo di Sciara, G. 1993. *The Dolphin Project: A bottlenose dolphin research and conservation program in the Northern Adriatic Sea*. Tethys Research Institute Technical Report TRI 93-03, Veli Losinj, 13 pp.
- Brusina, S. 1889. Sisavci Jadranskog mora. Rad Jugosl. akad. znan. i umj., Zagreb, 95(10): 79-177.
- Crnkovic, D. 1958. Problem dupina. Morsko ribarstvo, Zagreb, 1: 12-14.
- Gorjanovic-Kramberger, D. 1884. Fosilni sisari Hrvatske, Slavonije i Dalmacije. Rad Jugosl. akad. znan. i umj., Zagreb, 69.
- Gorjanovic-Kramberger, D. 1892. O fosilnih Cetaceih Hrvatske i Kranjske. Rad Jugosl. akad. znan. i umj., Zagreb, 15(111): 1-21.
- Hirtz, M. 1921. Kitovi u nasim vodama. Lovacko-ribarski vijesnik, 30: 34-35.
- Hirtz, M. 1922. Kit debeloglavac, *Globicephala melas* (Traill) u vodama Hrvatske. Glasn. Hrv. prirodosl. drustva, Zagreb, 34(1): 84-89.
- Hirtz, M. 1933. Kljunata uljarka (*Hyperoodon ampullatus* Forst.) u vodama Jadrana. Priroda, 23: 21-24.
- Hirtz, M. 1937. Rijetke vrste delfina u vodama Korcule. Priroda, 27(1): 25-28.
- Kolombatovic, G. 1882. Mammiferi, anfibi e rettili della Dalmazia e pesci rari e nuovi per l'Adriatico che furono catturati nelle acque di Spalato. A.Zannoni, Split, 18-19.
- Kolombatovic, G. 1885. Imenik kraljesnjaka Dalmacije. I. dio: Sisavci i ptice. Godisnje izvjesce c. kr. vel. realke u Splitu za god. 1884.-85. A.Zannoni, Split. 10 pp.
- Kolombatovic, 1894. O navodima meci (Cephalopoda) i kraljesnjaka (Vertebrata) Jadranskoga mora. A.Zannoni, Split. 54 pp.
- Kolombatovic, 1896. Zoologiske vijesti iz Dalmacije. A.Zannoni, Split, 1-6.
- Kosic, B. 1892. Njeke vijesti o sisavcima Jadranskog mora kod Dubrovnika i okolice. Glasnik Hrv. naravosl. drustva, Zagreb. 9 pp.

THE HARBOUR PORPOISE, *PHOCOENA PHOCOENA RELICTA* IN WATERS OFF CRIMEA

Andrey A. Artov

BREMA Laboratory, R. Luxembourg 27-2a,
Simferopol, 333720 Crimea, Ukraine

MAIN DANGERS FOR THE BLACK SEA HARBOUR PORPOISE In waters off Crimea, bycatches in fishing nets, marine pollution, disease, lack of a suitable feeding habitat, and physical influences are the main negative factors currently affecting dolphins. But these factors affect each of the three cetacean species to different extents. All three species have undergone strong reductions in food availability but it is not possible to determine the precise impact of this on each species. Other factors, in our opinion, most affect the harbour porpoise. We would like to consider these separately.

Bycatches in fishing gear According to official data of the Crimea Fish Protection Service (CFPS), 1,827 Black Sea dolphins were bycaught off the Crimea and northern Caucasus coasts from 1968 to 1990 (Reports of the Crimea Fish Protection Service, 1977-1990). Harbour porpoises represented 78.4% of the total number.

Marine pollution According to data on organochlorine pesticide contents (Birkun *et al.*, 1992a) in the blubber of Black Sea dolphins, the pollutant levels in harbour porpoise blubber are higher than those in bottlenose and common dolphins. Harbour porpoise appear to be the main target for organochlorine pollution, possibly as a result of their coastal habit, and their diet of mainly benthic fish.

Diseases Eight species of helminths were described in harbour porpoises compared with six in bottlenose dolphins and six in common dolphins (Krivokhizhin, 1992). According to studies of dolphins stranded on the Crimea coast from 1989-1991 (Birkun *et al.*, 1992a, 1992b) all harbour porpoises examined had undergone pulmonary nematode infections complicated by bacterial super-infection, compared with 67% of bottlenose and 49% of common dolphins.

Physical influence It is not possible to identify specific impacts upon the harbour porpoise, but one fact is known. About two thousand harbour porpoises died as a result of an oil-well explosion in the centre of the Sea of Azov in summer, 1982 (Yukhov, 1993).

From this consideration, we can conclude that harbour porpoises are the closest to local extinction. The fear is confirmed by the data on cetacean mass mortalities in 1990 when 270 carcasses were found on the Crimea coast (Birkun *et al.*, 1992b). 82% of stranded dolphins were harbour porpoises, and 80% of these were immature animals.

CONSERVATION ACTION Can some drastic measures be suggested to prevent the disappearance of porpoises from the Black Sea? There are several important measures which could be taken.

Protection in sanctuaries Twenty-four coastal protected areas with different levels of protection exist in the Crimea (Krukova *et al.*, 1988). Marine portions of these should be studied for the presence of harbour porpoise and any indications of migratory patterns. In suitable areas, special protection measures should be established. Further coastal areas suitable for harbour porpoise should be found and given protection. One such area is the Laspi Bay, southern Crimea. During winter 1994, large numbers of harbour porpoises swam into the waters of the bay, approaching the shore at night. Apparently the bay is a winter feeding zone for the harbour porpoise which feeds on anchovy wintering in the bay

and nearby. The bay is close to a coastal area which is already protected, and may be included with this.

Release from fishing nets and rehabilitation To reduce harbour porpoise mortality in fishing nets, the animals should be disentangled from the nets. This activity will require an adequate system to record entanglements and the ability of a "rescue" team to act promptly. But the disentanglement from gillnets will only be effective in shallow waters where there is a possibility of animals rising to the surface if only for a short time to breathe.

Those entangled porpoises which are sick or traumatised can be placed in a special rehabilitation centre along with other sick individuals. After a course of treatment and rehabilitation, the animals should be released. This will require the determination of the precise criteria for identifying whether a harbour porpoise is sick or not, and establishment of a facility for rehabilitation.

A programme for developing a system of rescue and rehabilitation of Black Sea dolphins should be started by BREMA Laboratory in 1994, according to a Ukraine Ministry of Environment order.

Fishing restrictions, and modifications of fishing gears and practices First porpoise-fish interactions off Crimea should be studied. These data will allow one to decide what fisheries, fishing areas and seasons should be closed. In order to modify fishing gear and practices, detailed studies of bycatches are needed. A large section of the Crimea fishery is illegal. In our opinion, legal fishing is only "the tip of the iceberg". When considering the problem of poaching, all the various complex economic, legal and state control questions should be included.

ACKNOWLEDGEMENTS I thank Alexey A. Birkun, Sergey V. Krivokhizhin and Vadim V. Pavlov for their help.

REFERENCES

Birkun, A.A., Jr, Krivokhizhin, S.V., Shvatsky, A.B., Miloserdova, N.A., Radygin, G.Yu., Pavov, V.V., Nikitina, V.N., Goldin, Ye.B., Artov, A.M., Suremkina, A.Yu., Zhivkova, Ye.P. and Plebansky, V.S. 1992a. Present status and future of Black Sea dolphins. Pp. 47-53. In *European Research of Cetaceans - 6* (Editor: P.G.H. Evans). Proc. 6th Ann. ECS Conf., San Remo, 20-22 February, 1992. European Cetacean Society, Cambridge, England.

Birkun, A.A., Jr, Krivokhizhin, S.V., Shvatsky, A.B., Radygin, G.Yu. 1992b. On mass mortality of Black Sea dolphins. Pp. 6-8. In *Problems of pathology and health protection of wild animals*. Proc. Intern. Sym. Astrakhan, 5-9 October. Moscow.

Krivokhizhin, S.V. 1992. New data on helminths of Black Sea dolphins. Pp. 21-23. In *Problems of pathology and health protection of wild animals*. Proc. Intern. Sym. Astrakhan, 5-9 October. Moscow.

Krukova, I.W., Luks, Yu.A., Privalova, L.A., Kostin, D.V. 1988. *Rare plants and animals of Crimea*. Tavria, Simferopol. 176 pp.

Reports of the Crimea Fish Protection Service. 1977-1990. Official documents.

Yukhov, V. 1993. Lot of Black Sea dolphins. *Krymskaya gazeta*, 63 (196): 3.

CETACEAN SIGHTINGS FROM A VANTAGE POINT ON THE AZOREAN ISLAND OF PICO DURING THE SUMMER OF 1993

André G. Silva^{*,***}, Manuel E. dos Santos^{*,***},
Stefan Harzen^{**,*} and Serge Viallelle^{****}

*Instituto Superior de Psicologia Aplicada, Unidade de Investigação em Eco-Etologia,
Rua Jardim do Tabaco, 44, P-1100 Lisboa, Portugal

**Dept. of Ethology, University of Bielefeld, P.O.Box 8640,
33615 Bielefeld, Germany

***Projecto Delfim, Praceta Gonçalves Zarco, 5, 4º Dto, P-2780 Oeiras, Portugal

****Espaço Talassa, Caminho do Baixo, 17, São Pedro,
9700 Angra do Heroísmo, Açores, Portugal

INTRODUCTION Twenty-one species of cetaceans have been recorded in the waters of the Azores (see Reiner, 1990; Reiner *et al.*, 1993). This mid-Atlantic archipelago is made up by nine islands (see map) spread throughout a platform of 2,352 km².

The islands are of volcanic origin, and many have high cliffs. In whaling times, watch huts (called "vigias") were built around some of the islands, such as on Pico, where one is now used in association with whale-watching. Sperm whales are still commonly sighted but also several other species. We decided to test the potential of this vantage point to detect, identify, observe and count cetaceans.

METHODS The vantage point is located on the south coast of the island of Pico, near the town of Lajes. The "vigia" is about 200 m away from the cliff edge, at an altitude of 75 m, and with the approximate position of 38° 23' N, 28° 14' 20" W. During August 1993, sixteen days of observation were completed, usually lasting from 09.00 h to 19.00 h.

With the assistance of a previous whaling employee (now working for a whale-watching company) and using 15x60 Zeiss binoculars and a compass, the occurrence and movements of cetacean groups were recorded, with estimates of the distance from shore. It was usually possible to cover an area up to about 10 miles offshore, where depths of 1,800 m are reached.

During times when the whale-watching boat was active, it was possible to obtain further information about the cetacean groups. The "vigia" was in permanent radio contact with the boat, whose crew could confirm the identification (which was especially useful in the case of the small delphinids), participate in the counts or estimates, and make photographs.

RESULTS Information about the sightings obtained is summarised in Table 1.

Twelve mixed groups were observed. It was possible to identify the following species combinations:

Tursiops truncatus-Globicephala sp.
Stenella frontalis-Globicephala sp.
Stenella frontalis-Stenella coeruleoalba
Stenella frontalis-Delphinus delphis
Delphinus delphis-Stenella coeruleoalba

DISCUSSION We are well aware that these data are very limited and certainly biased, and surely do not represent relative abundances of the species detected. It is shown, however, that not only are these waters rich in cetaceans, but also promising in terms of

research and educational activities. Powerful land-based tools such as computerized theodolites may provide valuable data through a more systematic programme.

A few peculiarities may be noted. Apparently, the number of sperm whale sightings was exceptionally low. On the other hand, beaked whales were quite common, even though the species could be determined in only one instance. In many cases, observed delphinids could not be identified due to limited visibility and lack of boat presence. Our suspicion was that most of them were probably *Stenella* or *D. delphis*. Finally, the regularity of bottlenose dolphin sightings close to shore clearly invites a more focused investigation.

REFERENCES

Reiner, F. 1990. Records of marine mammals of the Azores Islands. Garcia da Orta, Série de Zoologia, 15(2): 21-36.

Reiner, F., Gonçalves, J. M. and Santos, R. S. 1993. Two new records of Ziphiidae (Cetacea) for the Azores with an updated checklist of cetacean species. Arquipélago (Life and Marine Sciences), 11A: 113-118.

Table 1 Summary of Sightings data

Species	Nr. of Groups	%	Days	Group Size	
				Mean	SD
<i>T. truncatus</i>	27	17.20	12	15.11	9.12
<i>Globicephala sp.</i>	14	8.92	6	9.93	8.00
<i>D. delphis</i>	10	6.37	8	26.20	12.15
<i>S. coeruleoalba</i>	7	4.46	4	17.86	4.30
<i>S. frontalis</i>	7	4.46	6	28.43	10.80
<i>Mesoplodon sp.</i>	28	17.83	12	3.64	2.42
<i>P. macrocephalus</i>	2	1.27	2		
Ziphiid	1	0.64	1		
<i>O. orca</i>	2	1.27	1		
<i>G. griseus</i>	1	0.64	1		
<i>P. crassidens</i>	1	0.64	1		
Undetermined delphinids	45	28.66	13		
Mixed groups	12	7.64	6		
Total	157				

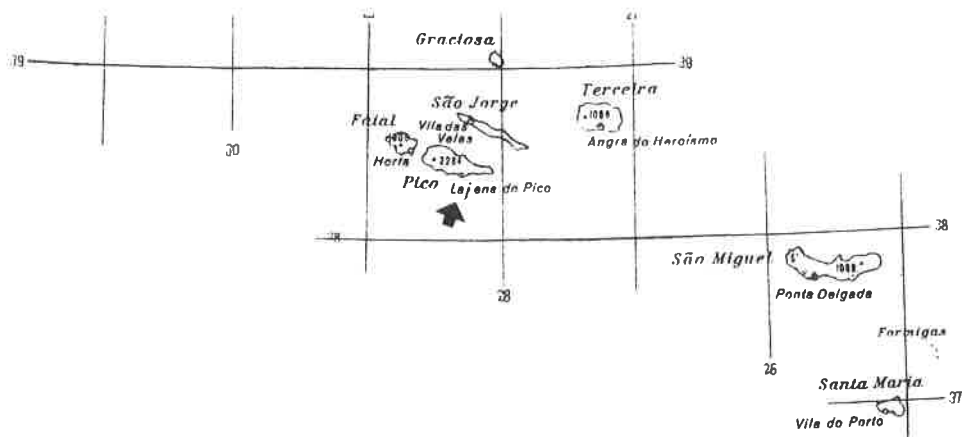

Fig. 1 Map of the Azores Islands

STRIPED DOLPHINS FROM THE MEDITERRANEAN AND THE SEA OF JAPAN: TWO SIDES OF THE SAME COIN?

A. Aguilar*, N. Calzada*, E. Grau* and C. Lockyer**

* Department of Animal Biology, Faculty of Biology,
University of Barcelona, Spain

** Sea Mammal Research Unit, N.E.R.C.,
Madingley Road, Cambridge, CB3 0ET, UK

Management of marine mammals relies on the existence of density-dependence mechanisms that ensure increase in population productivity when density decreases. However, the nature of these mechanisms in small cetaceans is poorly understood. We determined and compared ten biological parameters associated with growth and maturity for the striped dolphin inhabiting the western Mediterranean sea and the Sea of Japan, two areas in which the density of the species and its equilibrium with the habitat has followed opposed trajectories.

Parameters examined were: maximum body length, age and length at sexual maturity in females, length at birth, age and length at fusion of vertebral epiphyses, age and length at fusion of nasal bones, and age and length at fusion of distal rostrum.

Results suggest that the only parameter susceptible to density-dependence is age at sexual maturity. Length-related parameters remained remarkably constant between geographical regions when scaled for variation in maximum body size.

GEOGRAPHICAL VARIATION IN BODY SIZE IN WESTERN MEDITERRANEAN STRIPED DOLPHINS *STENELLA COERULEOALBA*

N. Calzada and A. Aguilar

Dept of Animal Biology, Faculty of Biology,
University of Barcelona, 08071 Barcelona, Spain.

INTRODUCTION Maximum body size of a species is a biological trait modulated by the characteristics of the environment (Boyce, 1979; Searcy, 1980). In cetaceans, intraspecific variation in body size between individuals inhabiting different geographic regions has been documented for a number of species. This variation usually occurs among allopatric populations or between offshore and inshore forms - sometimes overlapping in distribution - of the same species. For example, southern baleen whales have larger body sizes than their northern hemisphere conspecifics and, in blue and minke whales, the existence of "pygmy" forms with a sympatric distribution with the large-sized forms has led to the recognition of nominal subspecies (Brodie, 1977). In some small odontocetes with a wide geographical distribution, like common or bottlenose dolphins, variation in body size is frequent (Perrin, 1984). Understanding of such patterns of variation is a prerequisite to determine length parameters associated with reproductive or growth events, and to establish the biological characteristics of a population. Because a number of studies of this type on the striped dolphins inhabiting the western Mediterranean are currently underway, we considered it relevant to study variation in body size of this species throughout the basin.

MATERIALS AND METHODS Data from stranded or captured striped dolphins from the western Mediterranean were compiled from the literature and databases. In order to restrict the analysis to adult individuals, and taking into account that previous studies on reproduction of this population suggest that sexual maturity is attained at a length of about 190 cm in both sexes, only those individuals larger than 195 cm were included in the data subset used in the analyses. The final database in the Mediterranean included lengths from 291 dolphins (157 males and 134 females). The western Mediterranean basin was initially divided into eight subsectors (Figure 1). Exploratory screening of the frequency distributions of lengths of individuals originating from each subsector was carried out separately. However, after verifying the absence of variation in maximum body lengths between some of these subsectors, data were pooled into two main latitudinal areas, separated by the parallel corresponding to 41° N. Because data distributions had been truncated in their lower tails and were therefore expected to depart from normality, statistical comparisons between sectors were made using nonparametric Kruskal-Wallis and Mann-Whitney tests.

RESULTS AND DISCUSSION Males were about 2 cm larger than females. This sexual dimorphism in body size, with males larger than females, is common to most odontocetes and probably reflects polygynous behaviour in the species. Preliminary analysis of data suggested an increase in body lengths from north to south but an absence of variation from east to west. Therefore, we pooled body lengths from dolphins originating from subsectors located at the same latitude but different longitude, and found significant differences ($p < 0.05$) between dolphins originating north or south of parallel 41° N. This latitudinal threshold is, however, an artificial segregation of the data to facilitate statistical analysis, and body lengths actually increased from north to south in a progressive manner. Thus, maximum body lengths were attained in the southern fringe of the distribution range of the species. It should be pointed out that length distributions of southwestern Mediterranean striped dolphins were also significantly different ($p < 0.001$) than those from dolphins inhabiting the eastern North Atlantic, the latter being about 5 to 8 cm longer than the former (Figures 1 and 2). Therefore, the latitudinal cline observed in body lengths cannot be considered to be caused by an influx of dolphins from the Atlantic, passing to the

Mediterranean through the Gibraltar Straits, but to intrinsic variation in individuals inhabiting the western Mediterranean basin. Large body size is usually associated with unstable environments that require animals to accrue large amounts of fat to cope with periods of low feeding (Lindstet and Boyce, 1984). Further, body size has been inversely correlated with population density. It is likely that the differences observed reflect such environmental characteristics of the areas that could lead to a certain degree of genetic isolation within the population of striped dolphins.

REFERENCES

- Boyce, M. 1979. Seasonality and patterns of natural selection for life histories. *Am. Nat.*, 114: 569-583.
- Brodie, P. F. 1977. Form function and energetics of cetacea: a discussion. Pp 45-58. In *Functional anatomy of marine mammals*, Vol. 3 (Editor R. J. Harrison). Academic Press, London.
- Lindstet S. L. and Boyce M. 1985. Seasonality and fasting endurance, and body size in mammals. *Am. Nat.*, 125: 873-878
- Perrin, W. F. 1984. Patterns of geographical variation in small cetaceans. *Acta Zool. Fenica*, 172: 137-140.
- Searcy, W. A. 1980. Optimum body sizes at different ambient temperatures: an energetics explanation of Bergmann's rule. *J. theor. Biol.*, 83: 579-593.

ICONA and CICYT project NAT91-1128-C04-02 funded this research.

MALES

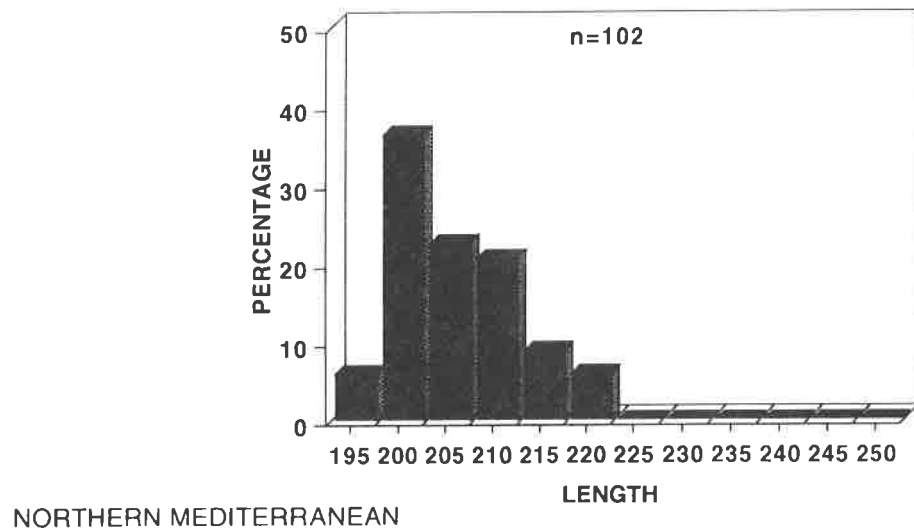
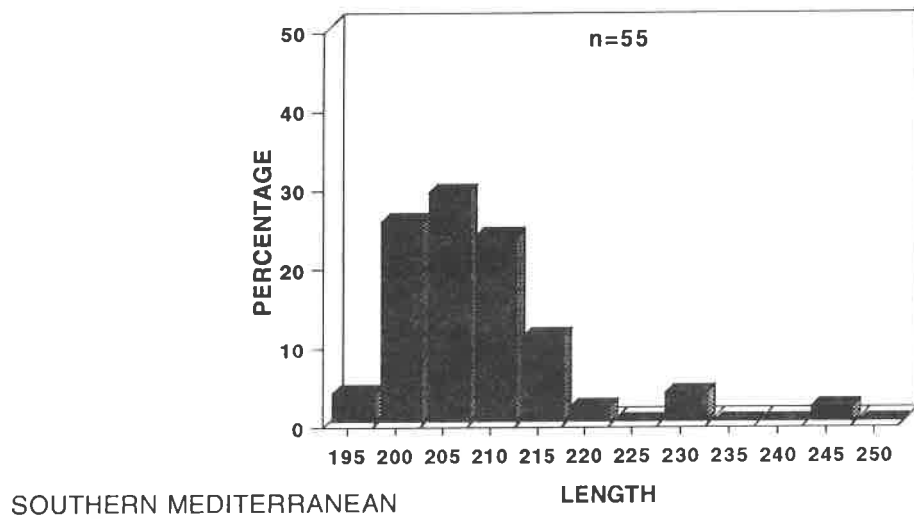
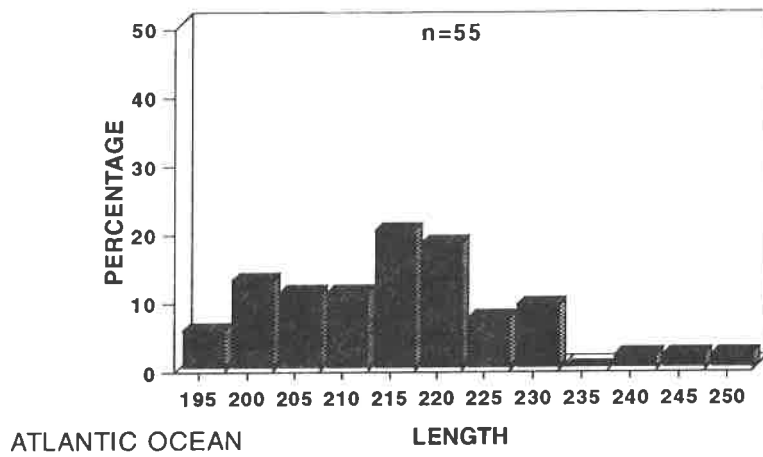

Fig. 1 Length distributions of male striped dolphins in Atlantic Ocean, southern and northern Mediterranean seas

FEMALES

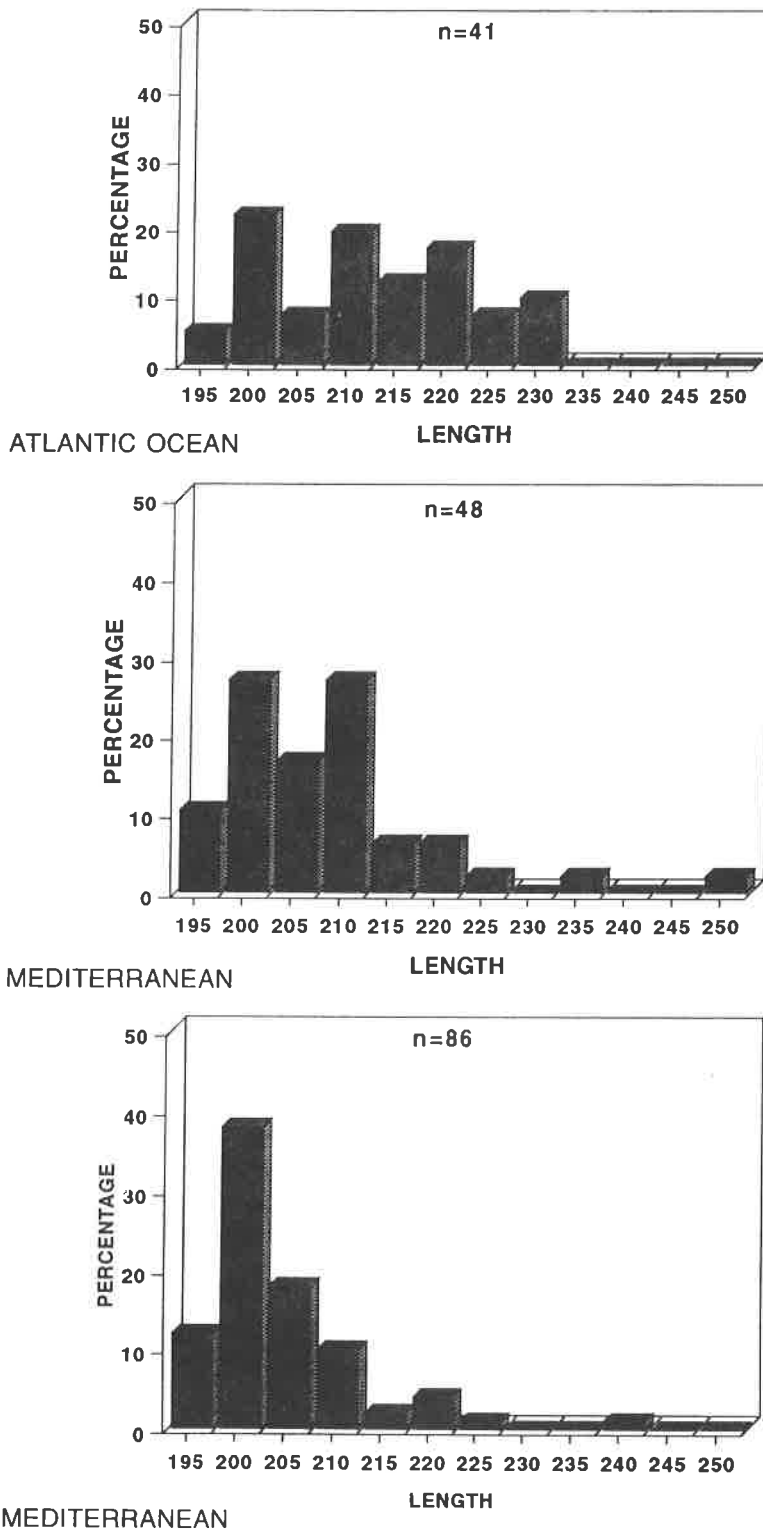

Fig. 2 Length distributions of female striped dolphins in Atlantic Ocean, southern and northern Mediterranean seas

**ANALYSIS OF THE VARIABILITY IN THE PIGMENTATION OF
STRIPED DOLPHIN *STENELLA COERULEOALBA* (MEYEN, 1833),
IN THE CENTRAL TYRRHENIAN SEA**

Tiziana Valentini, Luca Marini and Carlo Consiglio.

Dipartimento di Biologia Animale e dell'Uomo,
Università degli Studi di Roma "La Sapienza",
Viale dell'Università 32, 00185 Roma, Italy.

INTRODUCTION Some studies have shown the variability in the pigmentation of striped dolphins (*Stenella coeruleoalba*) Fraser and Noble, 1970; Mitchell, 1970). However, dead animals or sketches drawn from them have usually been utilised. A previous study in the Mediterranean Sea (Acquarone and Notarbartolo di Sciara, 1992) has investigated *Stenella* pigmentation patterns using a photographic technique. However, the relative frequencies have not been quantified.

The aim of this research is to investigate the main characteristics and their relative variability within the population of *Stenella coeruleoalba* present in the Central Tyrrhenian Sea, and to determine if such variations are specific to different areas.

MATERIALS AND METHODS Thirty-eight prints in black and white (Ilford 400 ASA) and three colour prints from slides (Ektachrome 200 ASA) have been used for this work. Forty-six individuals have been studied in total.

The photos have been collected during the survey of cetaceans in the Central Tyrrhenian Sea from 1989 to 1992, along the route used by the ferry boats of the National Railway Board between Civitavecchia (Latium) and Golfo Aranci (Sardinia) (Marini *et al.*, 1992; Marini *et al.*, in press).

For each specimen, the form illustrated in Table 1 (modified from Fraser and Noble, 1970) has been used, eleven morphological features have been chosen, with two or three possible variations for each element. Each individual has then been analysed dividing up on the form the variations according to each analysis element.

RESULTS AND CONCLUSIONS *Stenella coeruleoalba* shows great variability in pigmentation pattern. Nevertheless, from the number of individuals recorded possessing a particular morphological feature (Table 1), some characteristics are generally more common than others. This has enabled us to outline the "typical" pigmentation of a *Stenella coeruleoalba* (Table 2).

For some morphological features, it has not been possible to identify one particular pattern (see features 3, 8, 11) as being more common than any other.

All but one of the specimens analysed differ from the "typical" *Stenella coeruleoalba* at least in one variant.

The pigmentation of each individual is therefore characterised by a group of variations, some individuals exhibiting a certain number of common variations; animals with similar patterns have been divided into two subgroups "A" and "B", and the sighting positions of each individual has been plotted onto a nautical chart. This has shown no relationship between the pigmentation patterns and the sighting areas (Table 3).

ACKNOWLEDGEMENTS We wish to thank Barbara Catalano for her help in preparing the manuscript of this paper.

REFERENCES

- Acquarone, M. and Notarbartolo di Sciara, G. 1992. Pigmentation patterns of the striped dolphin, *Stenella coeruleoalba*, (Meyen,1833) in the Central Mediterranean Sea. Pp. 203-205. In *European Research on Cetaceans- 6* (Ed. P.G.H. Evans). Proc. 6th Ann. Conf. ECS, San.Remo, 20-22 February, 1992. European Cetacean Society, Cambridge, England. 249 pp.
- Fraser, F. C. and Noble, B. C. 1970. Variation of pigmentation pattern in Meyen's dolphin, *Stenella coeruleoalba* (Meyen). *Investigations on Cetacea*, Berne, 2: 147-163.
- Marini, L., Consiglio, C., Angradi, A. M., Sanna, A. and Valentini, T. 1992. Cetacean sightings programme in the Central Tyrrhenian Sea: results of the second year of activity. Pp. 66-68. In *European Research on Cetaceans - 6* (Ed. P.G.H. Evans). Proc. 6th Ann. Conf. ECS, San.Remo, 20-22 February, 1992. European Cetacean Society, Cambridge, England. 249 pp.
- Marini, L., Consiglio, C., Catalano, B. and Valentini, T. 1993. Cetaceans in the Central Tyrrhenian Sea. Third (and last?) year of sightings. Preliminary results. In *European Research on Cetaceans - 7* (Ed. P.G.H. Evans). Proc. 7th Ann. Conf. ECS, Inverness, 18-21 February, 1993. European Cetacean Society, Cambridge, England. 306 pp.
- Mitchell, E., 1970. Pigmentation pattern evolution in the delphinid cetaceans: an essay in adaptive coloration. *Can. J. Zool.*, 48: 717-740.

Table 2 Typical pigmentation pattern for striped dolphin

Typical features

- 1) Eye stripe - marked
- 2) Spinal blaze - until to the half of the black blaze
- 3) Black blaze - the apex ends to the posterior edge of the flipper
- 4) Pigmentation of the black blaze- with lighter central area
- 5) Flipper stripe - marked
- 6) Eye to anus stripe - marked
- 7) Stripe subtending the eye to anus stripe - present (in the few considered cases)
- 8) Over eye white bow - higher/lower
- 9) Baseline of the flipper - marked
- 10) Flipper - lighter in the center, darker on the edges
- 11) Central blaze of the dorsal fin - present/lacking

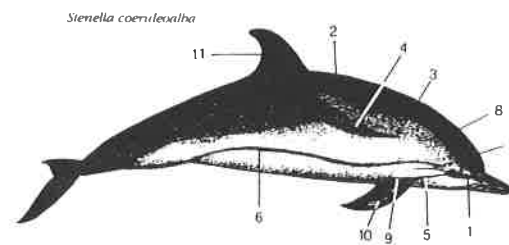
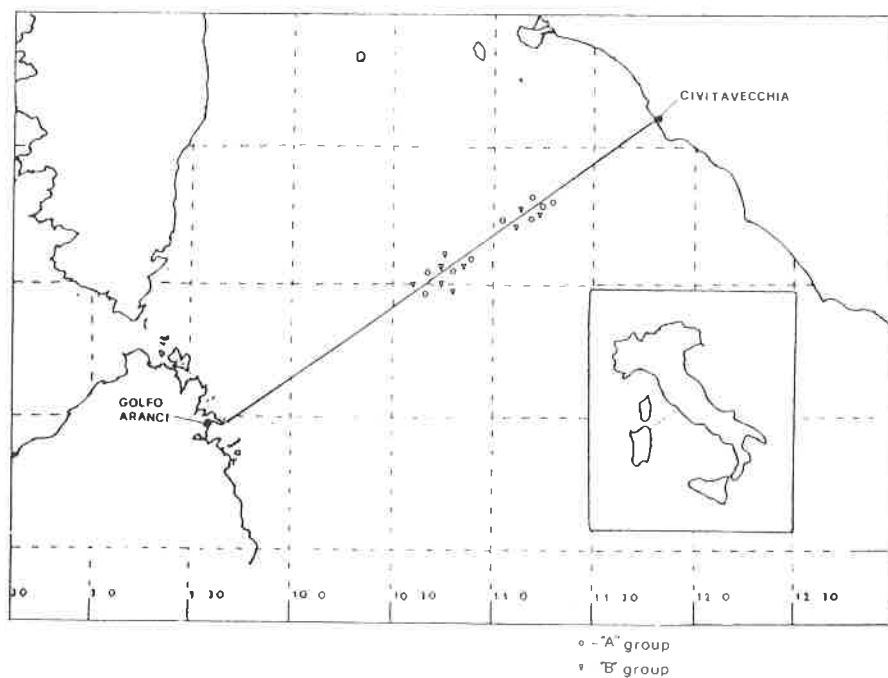

Table 3 Relationship between different pigmentation patterns and sightings area



TEETH OF MARINE MAMMALS: TOOLS FOR AGE DETERMINATION AND MUCH MORE

Christina H. Lockyer

Sea Mammal Research Unit, c/o British Antarctic Survey, High Cross,
Cambridge, CB3 0ET, UK

The structure of the marine mammal tooth is briefly described using examples of the southern elephant seal, (*Mirounga leonina*), and cetaceans, long-finned pilot whale (*Globicephala melas*) and harbour porpoise (*Phocoena phocoena*), with particular reference to the reliability of counting growth layer groups (GLG's) in dentine and cement, and the method of preparation.

Methods of validation of using GLG's for age are presented for known history individual bottlenose dolphins (*Tursiops truncatus*), short-finned pilot whale (*G. macrorhynchus*) and Commerson's dolphin (*Cephalorhynchus commersonii*) and the use of time-marking with tetracycline medication. Age is used widely in estimating growth, and examples of this in terms of body length and weight are presented for harbour porpoise from British waters. Age is also widely used in population studies to examine age distribution and biological parameters such as survival rates and age at sexual maturation. Findings are presented for porpoises from British waters.

The inherent pattern of the GLG's in teeth is characteristic for an individual, and has the potential to provide information about the individual's life history. By examining teeth from captive *G. macrorhynchus*, it is clear that nutrition and reproductive condition may have an effect on the growth of teeth, causing mineralisation anomalies. Examples of such anomalies in teeth of free-living populations of *G. melas* and *P. phocoena* are examined to demonstrate that certain life history events may be detected, including possible environmental factors which could influence nutritional status. Additionally, variations in the GLG patterns and incidence of anomalies in teeth of populations from different geographical areas, may be potentially useful for population identity.

PRELIMINARY COMPARISON BETWEEN AVERAGE AGE AT FIRST OVULATION AND AT FIRST LACTATION IN LONG-FINNED PILOT WHALES OFF THE FAROE ISLANDS

Geneviève Desportes

Stejlestræde 9, Bregør, 5300 Kerteminde, Denmark

INTRODUCTION In cetacean studies, the attainment of sexual maturity in females is usually taken as being the first ovulation. There has been some discussion as to whether this definition is adequate for modelling purposes and the age at first parturition could be taken as the mean age at maturity plus the gestation period (Perrin and Donovan, 1984). However, few studies investigate whether first ovulations actually result in a birth and that first pregnancies are likely to be as successful as later ones, in other words, whether there is any difference other than that normally expected between the age at first ovulation and the age at first lactation. There are, however, irreversible changes in the mammary gland that reflect lactation (Vorherr, 1974: 182-280, in Larson, 1978; Lascelles and Lee: 115-177, in Larson 1978; Perrin and Donovan, 1984; Bryden *pers. comm.*) which may be observed by histological examination. Looking for these changes in young females will indicate whether they have successfully maintained pregnancy at least until full term and the start of lactation, thus providing a tool to obtain the mean age at first lactation.

The feasibility of using histological examination of mammary glands to detect past lactation was investigated in Faroese long-finned pilot whales (*Globicephala melas*) and the average age at first ovulation and first lactation were then compared.

MATERIALS AND METHODS Histological examination of mammary tissue was performed on 246 mammary glands from 192 females belonging to 23 schools of long-finned pilot whales taken in the Faroese drive fishery in the period 1986-89. Samples for histology were processed using standard techniques and stained with Haematoxylin-Eosin.

The average age at attainment of sexual maturity, ASM, and the average age at attainment of lactating status, ALS, were both estimated using the same data set, i.e., seven schools for which data on past or present lactation were known for all the 202 females. ASM and ALS were estimated using the non-parametric method of the sum of the fraction of immatures, described by Hohn (1989).

In some cases, it was not possible to identify with certainty whether a non-lactating female had already lactated or not. Therefore the ALS was calculated using two ways of combining the same data set. In one case, the doubtful females were all classified as having already lactated, in the other case, the doubtful females were all classified as having never lactated. In this way, the extreme values of the range of data containing the true value of ALS were obtained.

RESULTS AND DISCUSSION Using histological examination of mammary glands to detect past lactation appeared to be successful in most pilot whale females. There were clear histological changes in the mammary gland that reflected lactation, and resting glands did not offer the same picture as immature glands.

Table 1 (a-c) presents the estimation of ASM and ALS on the same data set of seven schools of long-finned pilot whales. Although the gestation period is assumed to be one year in long-finned pilot whales (Martin and Rothery, 1993), results show that the age at first lactation seem to be delayed for several years, compared with the age at first ovulation, the delay ranging between three and six years.

No previous studies on cetaceans estimate the age of first lactation based on the history of mammary glands. The method has proved to be successful in long-finned pilot whales and the possibility of using it is currently investigated in porpoises (Hohn, pers. comm.). The delay in the ALS may have important implications for the population dynamics if it is confirmed as being the general pattern. A delay in ALS means either that females undergo several infertile ovulations over a few years before becoming pregnant, or that offspring mortality is high during or immediately after the first pregnancies. Young females are then normally impregnated, but the pregnancies do not come to term or newborns die within a very short period after birth, before the full lactating process is in place. This last hypothesis would better fit with the pregnancy rates given for younger females by Martin and Rothery (1993) and the foetal mortality pointed out by Desportes *et al.* (in press).

During this study, some cases of necrosis of glandular tissues of mammary glands were observed. Necrosis at different stages was observed in several females, ranging from immature to very old and probably senile, for example:

- a female, 47 years old and considered as senile on the basis of ovaries examination, exhibited a nearly complete involution of the glandular tissue. Very few lymphatic and blood vessels could be observed, and the gland was mostly composed of dense, fibrous connective tissue, surrounding a few islands of adipocytes.
- a pregnant female, 12 years old and carrying a 1.3 cm long foetus exhibited similar pictures, though at a less advanced stage of glandular tissue involution.
- a pregnant female, 14 years old and carrying a 157 cm long foetus, exhibited a gland showing lactiferous duct, but very little, if any, glandular parenchyma, resembling the picture observed in breast of male human beings (Pr. Hov-Jensen, Department of Pathology of the University Hospital of Copenhagen, Ridshospitalet, *pers. comm.*).

These cases suggest that some females, because of pathological and/or age-related changes occurring in the mammary glands, may not be able to sustain lactation, even if they can sustain a pregnancy. As most eutherians, cetacean calves are very immature at birth, and hence totally dependent on their mother's milk for a variable time thereafter. Lactation is an essential phase, and failure to lactate means failure to reproduce.

ACKNOWLEDGEMENTS This study was supported by the U.S. Department of Commerce - NOAA, requisition Number NL FM2150-2-52048, and the Faroese Museum of Natural History. Special thanks to the support of T. B. Sørensen during the histological examination.

REFERENCES

- Desportes, G., Andersen, L. W. and Bloch, D. In press. Variation in foetal and postnatal sex ratios in long-finned pilot whales. *Ophelia*, 39(3).
- Hohn, A. 1989. Comparison of methods to estimate the average age at sexual maturation in dolphins. Paper SC/41/O 28 presented to the IWC Scientific Committee, May 1989 (unpublished). 15pp.
- Larson, B.L. 1978. *Lactation a comprehensive treatise. IV.* Academic Press, New York. 595pp.
- Martin, A. R. and Rothery, P. 1993. Reproductive parameters of female long-finned pilot whales (*Globicephala melas*) around the Faroe Islands. *Rep. int. Whal. Commn (Special Issue 14)*: 263-304.
- Perrin, W. F. and Donovan, G. P. 1984. Report of the workshop. *Rep. int. Whal. Commn (Special Issue 6)*: 2-24.
- Vorherr, H. 1974. *The breast.* Academic Press, New York. 282pp.

Indeterminate Age Class	Total	Immature	Mature	Fraction immature	Fraction mature	No. of classes combined	$\frac{(pi)(qi)(xi)}{Ni - 1}$
	(Ni)	(Ii)*	(Mi)*	(pi)	(qi)	(xi)	
6	7	5	2	.71	.29	1	.034
7	2	2	0	.75	.25	1	.188
8	11	2	9	.18	.82	1	.015
9	4	0	4	.13	.88	1	.036
10	4	0	4	.13	.88	1	.036
11	4	1	3	.25	.75	1	.063
Total	32	10	22	-	-	-	-

Table 1a: Estimate of ASM. Immature, no corpora on ovaries pair, mature, at least one corpus on ovaries pair.

$$ASM = 6 + 2.15 = 8.15, \text{ s.e.} = 0.610$$

Indeterminate Age Class	Total	Immature	Mature	Fraction immature	Fraction mature	No. of classes combined	$\frac{(pi)(qi)(xi)}{Ni - 1}$
	(Ni)	(Ii)*	(Mi)*	(pi)	(qi)	(xi)	
8	11	9	2 (incl. 1)	.82	.18	1	.015
9	4	2	2	.50	.50	1	.083
10	4	2	2	.50	.50	1	.083
11	4	1	3	.25	.75	1	.063
12	5	0	5	.10	.90	1	.023
13	3	0	3 (incl. 1)	.17	.83	1	.069
14	4	1	3 (incl. 1)	.25	.75	1	.063
15	6	0	6 (incl. 1)	.08	.92	1	.015
16	6	0	6	.08	.92	1	.015
17 - 18	4	0	4 (incl. 1)	.13	.87	2	.073
19	6	1	5 (incl. 1)	.17	.83	1	.028
Total	57	16	41 (incl. 5)	-	-	-	-

Table 1b: Estimate of ALS, doubtful specimens (incl. n) are classified as mature. Immature, the female has never lactated; mature, the female has already lactated or is lactating.

$$ALS = 8 + 3.17 = 11.17, \text{ s.e.} = 0.728$$

Indeterminate Age Class	Total	Immature	Mature	Fraction immature	Fraction mature	No. of classes combined	$\frac{(p_i)(q_i)(x_i)}{N_i - 1}$
	(Ni)	(Ii)*	(Mi)*	(pi)	(qi)	(xi)	
8	11	10 (incl. 1)	1	.91	.09	1	.008
9	4	2	2	.50	.50	1	.083
10	4	2	2	.50	.50	1	.083
11	4	1	3	.25	.75	1	.063
12	5	0	5	.10	.90	1	.023
13	3	1 (incl. 1)	2	.50	.50	1	.125
14	4	2 (incl. 1)	2	.50	.50	1	.083
15	6	1 (incl. 1)	5	.25	.75	1	.038
16	6	0	6	.08	.92	1	.015
17 - 18	4	1 (incl. 1)	3	.38	.62	2	.156
19	6	2 (incl. 1)	4	.33	.67	1	.044
20	7	1 (incl. 1)	6	.14	.86	1	.020
21	5	2 (incl. 2)	3	.40	.60	1	.060
22	6	1 (incl. 1)	5	.17	.83	1	.028
23 - 24	2	4 (incl. 4)	4	.50	.50	2	.071
Total	83	30	53	-	-	-	-

Table 1c: Estimate of ALS, doubtful specimens (incl. n) are classified as immature. Immature, the female has never lactated; mature, the female has already lactated or is lactating.

$$ALS = 8 + 6.39 = 14.39, \text{ s.e.} = 0.949$$

Table 1a-c: Estimate of ASM and ALS, by the fraction immature method. * Zero values of Mi and Ii are replaced by 0.5.

**SEASONALITY AND SOCIAL MATURITY IN MALE LONG-FINNED
PILOT WHALES *GLOBICEPHALA MELAS* OFF THE FAROE ISLANDS**

G. Desportes*, M. Saboureau** and Lacroix, A.**

*Stejlestræde 9, Bregør, 5300 Kertminde, Denmark

**Centre d'Études Biologiques de Chizé,
F-79360 Beauvoir sur Niort, France

Seasonality of testicular activity and social maturity of male long-finned pilot whales (*Globicephala melas*) is described, based on material collected from 39 schools of long-finned pilot whales caught by the Faroese drive fishery in the period 1986-89, which includes 297 testes and 91 blood samples from maturing and mature animals. The determination of seasonal activity is based on morphological and histological examination of the testes, density of spermatozoa on epididymal smears and radioimmunoassays of plasma testosterone. Social maturity is investigated from school composition and morphological characters.

The testicular activity is diffusely seasonal and peaks between March and September. No complete standstill of testicular activity is observed and a not insignificant proportion of males are capable of reproducing outside the main breeding season. Testis weight increases about 1.5 times and testosterone concentration about 2.5 times during the period March-September. Testosterone concentration may have a bimodal pattern of secretion with a dip in July. The diffuse pattern of seasonality may be due, at least partly, to a non-geographical homogeneity of the schools sampled.

Histological maturity of testicular tissue is reached at a mean age of 17.0 yrs, but social maturity seems to be delayed for several years. School structure suggests that males move away from their natal school after puberty, aggregate in others or segregate, at least temporally.

VARIATION IN FOETAL AND POSTNATAL SEX RATIOS IN LONG-FINNED PILOT WHALES

G. Desportes*, L.W. Andersen** and D. Bloch*

*Museum of Natural History, FR-100 Tórshavn, Faroe Islands

**Natural Science Department, University of the Faroe Islands,
FR-100 Tórshavn, Faroe Islands

Present address: Stejlestræde 9, Bregndør, DK-5300 Kerteminde, Denmark

Present address: Institute of Biological Sciences, Department of Ecology and Genetics,
University of Aarhus, Building 540,
Ny Munkegade, 8000 Aarhus C, Denmark

INTRODUCTION Schools of long-finned pilot whales (*Globicephala melas*) in polar and temperate waters of the Northern and Southern Hemisphere, that have been driven ashore or mass stranded, usually comprise more females than males (Müller 1883, Bloch 1992). Off the Faroe Islands, an average of 4.4 mature females per mature male have been observed over a two-year period (Desportes *et al.*, 1993). The question addressed here is whether this predominance of postnatal females reflects simply a lower survival rate (Bloch *et al.*, 1993), or potential segregation of adult males (Desportes *et al.*, 1994b), or a biased sex ratio either at conception or at birth.

Evidence exists for variation in the secondary sex ratio at birth in many mammalian species. This variation may represent adaptive manipulation of the sex ratio change in the relative fitness of producing sons and daughters (Clutton-Brock, 1991). Such changes are influenced by factors such as demography, maternal status (e.g. age, fecundity, body condition, social rank) and external factors related to stress, habitat quality, population size and seasonality. These factors have not yet been analysed in cetaceans.

The sex ratio at birth in cetaceans is usually represented as the overall sex ratio in utero, although a decrease in the proportion of male foetuses with gestational age is a widespread feature of mammalian reproduction (Clutton-Brock and Iason, 1986).

MATERIALS AND METHODS Data were obtained from schools of long-finned pilot whales landed in the Faroe Islands from 1958 to 1992. Most sampling was carried out in connection with the 1986-88 Faroese international research program on the ecology and status of pilot whales (Desportes *et al.*, 1994a).

Our samples comprise 505 embryos and foetuses from 58 schools with body lengths ranging from 0.2 cm to 191 cm. The sex was identified by at least one of the three following methods: macroscopical examination, histological examination of gonadal tissues, and examination of sex chromatin (Andersen *et al.*, 1992).

Since length at birth does not differ significantly between males and females (Bloch *et al.*, 1993a), we assume that foetal growth rate is the same for both sexes and that variation in sex ratio measured as a function of length also represents variation as a function of time.

Unless otherwise specified, the sex ratio is given as the proportion of males in the sample.

Changes in sex ratio with gestational age. The proportion of male foetuses (expressed here as the natural logarithm of the number of males over the number of females) varies among 10 cm-length classes and shows a tendency to decrease as a function of foetus length.

The estimated logistic regression line is $\log_{it} = -0.04 - 0.004 \times \text{length}$, with a standard error on the slope of 0.00288. The hypothesis of the slope being zero was tested ($p = 0.072$) and accepted at the 5% level of probability.

The sex ratio at conception seems close to parity (Andersen *et al.*, 1992). The intra-uterine mortality is higher for males than females, which leads to a proportion of less than one male for two females at the time of the earliest births (foetuses $\leq 10\text{cm}$, 44% males; $150\text{cm} < \text{foetuses} < 163\text{cm}$, 30% males; G test, $p < 0.025$). The proportion of male foetuses is significantly higher among foetuses less than or equal to 60cm than among foetuses more than 60cm (47.1%, $n=155$ and 36.3%, $n=190$ respectively; Z test, $p < 0.03$).

The sex ratio changes during the gestation period in Faroese pilot whales indicate that mortality of male foetuses is greater than that of female foetuses. This difference is also noticeable in the Newfoundland pilot whales. When differential mortality occurs before parental investments ends, as in the present study, a reduced viability among the juveniles of one sex is expected to favour the initial production of the less viable sex. Preferential production of one sex is expected to reverse itself until the sex ratio is biased against the less viable sex during the period of independence (Clutton-Brock and Iason, 1986). The observation of this significant level of foetal mortality indicates that pregnancy rates will be an over-estimation of calf production if it is calculated over an entire pool of pregnant females regardless of foetal age, implicitly assuming that foetal mortality is absent.

Changes in sex ratio according to mother's age The proportion of males varies between classes and there is no significant association between sex ratio and age of the mother ($p = 0.226$ for the fitted logistic regression curve).

However, in females 25 years old or younger, the proportion of male foetuses is not significantly different from parity (46.6%, $n=163$), but females older than 25 years bear a higher proportion of female foetuses (72.0%, $n=50$; G test, $p < 0.01$).

Older female pilot whales (>25 years) appear to produce fewer male offspring than younger female pilot whales (<25 years), (Z test, $p < 0.03$), as observed in other mammalian species (Clutton-Brock and Iason, 1986). Parents in inferior conditions produce more daughters than sons. The fact that the bias against pilot whale male foetuses increases with the age of the female suggests that males are more costly to produce than females, and that females in less fit conditions are more likely to lose male offspring. In the present case this might be expected for the older female pilot whales since they have experienced several pregnancies. Alternatively, selection could favour production of males in younger females, since these offspring will leave the school. Female offspring, which remain in the school, later would directly compete for resources with their mothers. In pilot whales, schools consist of closely related females and their offspring not fathered by the present males, it is not clear whether adult males move between schools, remain in their natal school or segregate out alone (Amos *et al.*, 1991, Andersen, 1993).

Changes of sex ratio in peri- and postnatal stages Throughout pregnancy, the overall mortality is higher in males than in females. During the birth period and the first three years of life, the female sex bias decreases. Parity is observed by age group 3, and is maintained until age group 10. Then the sex ratio starts decreasing again to reach zero in the age class 10 (Bloch *et al.*, 1993). The foetal sex ratio in the length-class 120-162 cm was found to differ significantly from the sex ratio obtained by combining the age classes 3-10 (G-test, $p = 0.009$).

During the first years of life, the selection pressure changes, and operates mainly against females with parity reached again in the fourth year. Parity is maintained until males enter pubertal stage at 11 years of age (Desportes *et al.*, 1993). Thus, the factors leading to the observed predominance of females among postnatal individuals in pilot whale schools operate from puberty onwards.

CONCLUSIONS This study provides interesting evidence for differential foetal mortality in one direction and subsequent differential mortality of juveniles in the opposite direction.

Foetal mortality may not be negligible in cetaceans. It is therefore of great importance when measuring fecundity in population dynamics and management, to take into account the patterns and rates of foetal mortality.

The relationship between exploitation levels and foetal/juvenile sex ratios in various cetacean species, and the identification of factors leading to a sex biased mortality in neonates would be particularly interesting to study. Social structure and particularly the maternal dominance rank has been shown to strongly influence sex ratio variation in many mammals. Such factors might also help to explain part of the interspecific and between-school variation in secondary sex ratio of some cetacean species if more comprehensive data become available (see Desportes *et al.*, 1994, in press, for more detailed information).

REFERENCES

- Amos, W., Barret, J. and Dover, G. A. 1991. Breeding behaviour of pilot whales revealed by DNA fingerprinting. *Heredity*, 67: 49-55.
- Andersen, L. W., Desportes, G. and Friedrich, U. 1992. Sex identification of pilot whale foetuses off the Faroe Islands. *Marine Mammal Science*, 8(2): 184-187.
- Andersen, L. W. 1993. Further studies on the population structure of long-finned pilot whales *Globicephala melas* off the Faroe Islands. *Rept. Int. Whal. Commn (Special Issue 14)*: 219-232.
- Bloch, D. 1992. Studies of the long-finned pilot whale in the Faroe Islands, 1976-1986. *Frøðskaparrit (Annal. societ. scient. Faeroensis)*, 38-39: 35-61.
- Bloch, D., Lockyer, C. and Zachariassen, M. 1993. Age and growth parameters of the long-finned pilot whales off the Faroe Islands. *Rep. Int. Whal. Commn (Special Issue 14)*: 163-208.
- Clutton-Brock, T. H. 1991. *The evolution of parental care*. Princeton University Press.
- Clutton-Brock, T. H. and Iason, G. R. 1986. Sex ratio variation in mammals. *The Quarterly Review of Biology*, 60(1): 339-374.
- Desportes, G., Saboureau, M. and Lacroix, A. 1993. Reproductive maturity and seasonality of male long-finned pilot whales off the Faroe Islands. *Rep. Int. Whal. Commn (Special Issue 14)*: 233-262.
- Desportes, G., Bloch, D., Andersen, L. W. and Mouritsen, R. 1994a. The International Research Programme on the Ecology and Status of the long-finned pilot whale off the Faroe Islands: Presentation, Results and Perspective. *Frøðskaparrit*, 40: 9-30.
- Desportes, G., Andersen, L. W., Aspholm, P. E., Bloch, D. and Mouritsen, R. 1994b. A note about a male-only pilot whale school observed in the Faroe Islands. *Frøðskaparrit*, 40: 31-38.
- Desportes, G., Andersen, L. W. and Bloch, D. (in press). Variation in foetal and postnatal sex ratios in long-finned pilot whales. *Ophelia*, 39 (3).
- Müller, H. C. 1883. Oplysninger om Grindfangsten paa Føeørene. (Remarks on the pilot whaling in the Faroe Islands). *Vidensk. Medd. Dansk Nat. Foren.*, 44: 17-47.

REPRODUCTIVE PARAMETERS IN STRIPED DOLPHINS FROM THE MEDITERRANEAN AND ATLANTIC COAST OF FRANCE

Nathalie Di-Méglio* and Anne Collet**

* EPHE, Université de Montpellier II, 34095 Montpellier cedex, France

** Centre de Recherche sur les Mammifères Marins, Musée Océanographique, 17000 La Rochelle, France

INTRODUCTION It has been recently shown that growth in total body length and weight differs in Mediterranean and Atlantic striped dolphins (Di-Méglio, Romero-Alvarez and Collet, *in prep.*) The present investigation examines possible variations in reproductive parameters from two samples of striped dolphins found stranded on the Mediterranean or on the Atlantic coast of France.

MATERIALS AND METHODS The ages of ninety striped dolphins stranded on the Mediterranean and Atlantic coasts of France were estimated from the number of dentinal and cemental GLG's. The total body length of each dolphin was measured to the nearest centimetre and sexual maturity was determined from histological analysis of the gonads. Di-Méglio (1993) describes the criteria adopted to classify individuals within three groups (immature, pubertal and mature), and the methods used to determine the mean age and total body length at attainment of sexual maturity.

RESULTS AND DISCUSSION The results for male reproductive status are presented in Table 1, together with the interval of total body length and age (minimum and maximum) in each reproductive class (immature, pubertal, mature). Because of the very small sample size in each reproductive class, the total body length and age at attainment of puberty and sexual maturity have also been graphically determined (Figs. 1 & 2). This method (Kasuya, 1972) suggests that Mediterranean striped dolphins reach puberty at a mean total body length of 175 cm and a mean age of 8.5 years, and would then become sexually mature at a mean length of 178 cm and mean age of 14 years, while Atlantic males reach puberty at a mean length of 188 cm and age of 4 years, and sexual maturity at a mean length of 201 cm and 8 years of age. Although this method provides coherent results for Atlantic specimens (Table 1 and Figs. 1 & 2), it seems that the small sample size from the Mediterranean Sea introduces a bias since it is quite unlikely that males would grow only 3 cm between 8.5 and 14 years of age.

Table 2 summarises the results obtained for the reproductive status in females. The mean length and age at attainment of sexual maturity are graphically calculated as 180 cm (Fig. 3) and 14 years of age for Mediterranean females, and 197 cm and 10 years for Atlantic females.

Histological examination showed that testicular activity is observed all year round in both stocks, although some individual variations appear, especially in young mature specimens.

Looking at the total body length of foetus (N = 5), it seems that calving and mating occur in spring (April-May) within the Atlantic sample, while in the Mediterranean it extends from July to October.

CONCLUSIONS It appeared that for both sexes, the total body length and age at attainment of sexual maturity differ in the Atlantic and Mediterranean specimens. This most probably reflects the difference in growth of total body length and weight highlighted for these two samples (Di-Méglio, Romero-Alvarez and Collet, *in prep.*). The breeding season also differs within the two populations studied.

But, of course, these preliminary results should be considered with caution, because of the limited quantity and quality of samples from both areas: animals stranded over large portions of the coasts and over several years. The results require confirmation with analyses of larger and more homogeneous samples.

REFERENCES

Di-Méglio, N. 1993. Etude de la croissance chez *Stenella coeruleoalba*, comparaison ostéologique et variabilités biologiques entre les individus des côtes françaises atlantiques et méditerranéennes. Mémoire EPHE, Université de Montpellier. 150 pp.

Di-Méglio, N., Romero-Alvarez, R and Collet, A. (*in prep*). Growth comparison in striped dolphin, *Stenella coeruleoalba*, from the Atlantic and Mediterranean coasts of France.

Kasuya, T. 1972. Growth and reproduction of *Stenella coeruleoalba* based on the age determination by means of dentinal growth layers. Sci. Rep. Whal. Res. Inst., 24: 57-69.

Table 1 Interval of total body length and age (min-maxi) in each reproductive class, for male striped dolphins. Med. = Mediterranean sample, Atl. = Atlantic sample, N = number of individuals, TBL = total body length in cm, age in GLGs.

reproductive classes	Med. N	Med. TBL	Med. age	Atl. N	Atl. TBL	Atl. age
immature	3	130-174	1-7	12	152-206	0-6
pubertal	1	183	11	5	185-202	4-9
mature	5	182-203	17-22	17	207-241	7-29

Table 2 Interval of total body length and age (mini-maxi) in each reproductive class, for female striped dolphins. Med. = Mediterranean sample, Atl. = Atlantic sample, N = number of individual, TBL = total body length in cm, age in GLGs.

reproductive classes	Med. N	Med. TBL	Med. age	Atl. N	Atl. TBL	Atl. age
immature	3	157-206	6-14	8	158-211	3-10
mature	9	180-203	14-22	5	194-215	11-23

MALE PUBERTY

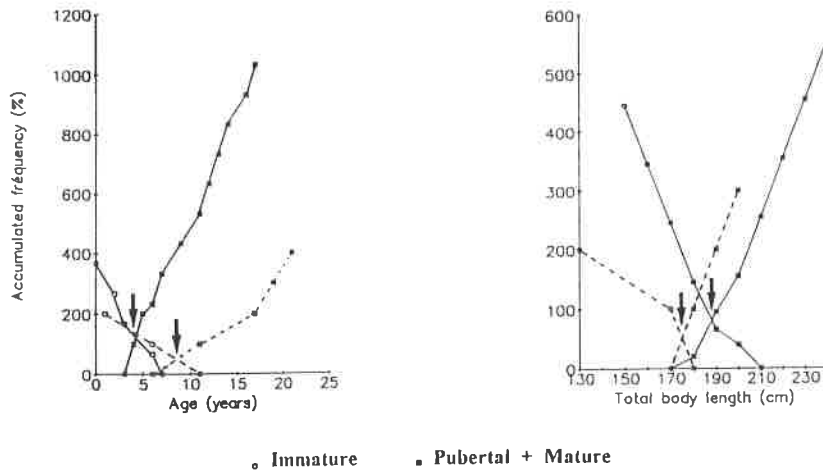

Fig. 1 Mean total body length and age at attainment of puberty in male striped dolphins from the Atlantic (plain line) and Mediterranean (dotted line) samples.

MALE SEXUAL MATURITY

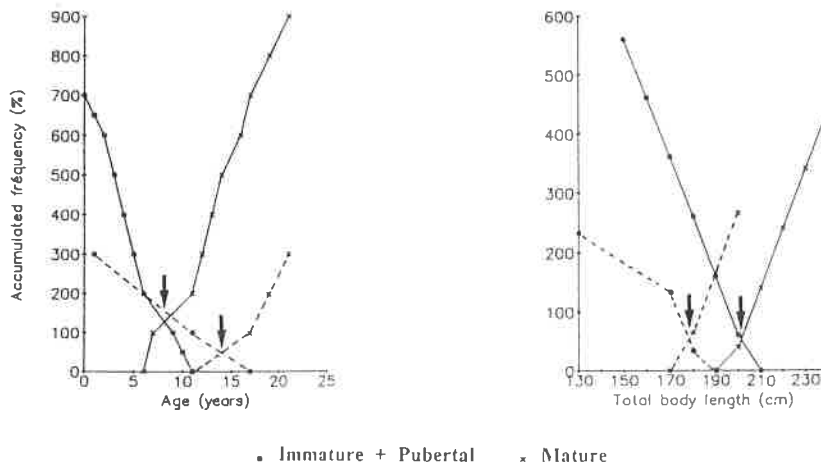

Fig. 2 Mean total body length and age at attainment of sexual maturity in male striped dolphins from the Atlantic (plain line) and Mediterranean (dotted line) samples.

FEMALE SEXUAL MATURITY

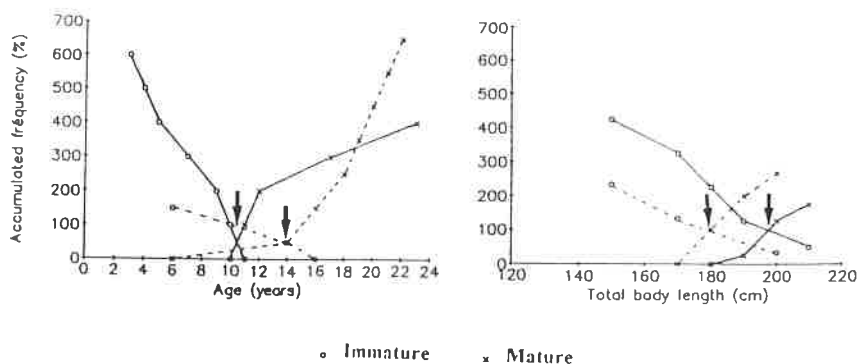

Fig. 3 Mean total body length and age at attainment of sexual maturity in female striped dolphins from the Atlantic (plain line) and Mediterranean (dotted line) samples.

GROWTH PATTERNS OF THE HARBOUR PORPOISE (*PHOCOENA PHOCOENA*) IN NORWEGIAN AND SWEDISH WATERS

S.E. Kaarstad*, A. Bjørge**, I. Lindstedt*** and J.A. Balbuena*

* Department of Animal Biology, University of Valencia,
46100 Burjasot, Valencia, Spain

** Norwegian Institute for Nature Research,
P.O. Box 1037 Blindern, 0315 Oslo, Norway

*** Aschebergsgatan 38, 41133 Gothenburg, Sweden.

INTRODUCTION In Swedish and Norwegian waters, the harbour porpoise *Phocoena phocoena* is subject to incidental bycatches but the impact on the population is still unknown. Establishing life history parameters is essential to understand the dynamics of any animal population. However, very little is known about those of the harbour porpoise in Scandinavian waters. Here, we present growth patterns of Swedish and Norwegian harbour porpoises.

MATERIALS AND METHODS This study is based on 74 males and 56 females from Norway, and 60 females from Sweden bycaught or stranded between 1988 and 1990. The age of the animals was determined by Mr T. Kvam (Norwegian Institute for Nature Research) following Kvam *et al.* (1989). To ease comparison with previous work (Read, 1989), the relationship between age and body length was described by Gompertz growth curves:

$$S = A \exp(-b \exp(-at))$$

where S is the standard length in cm; A, the asymptotic length; a and b are constants, and t is the age in years.

Absolute (AG) and relative (RG) growth rates were also calculated:

$$AG = dS/dt ; RG = AG/S \quad (\text{see Read, 1989}).$$

The growth parameters and their respective standard errors were estimated by the least squares method (LSM). LSM assumes that body length has a constant variance and is normally distributed in each age class (Kimura, 1980). These requirements were better met when we considered an additional age class of 0.5 yrs, including animals with no growth layer in the teeth caught in spring (i.e. before the birth season) (see also Hohn and Lockyer, 1990). The calculations were carried out with an SPSS/PC+ 4.0 statistical package (procedure NLR).

RESULTS The growth parameters of Norwegian and Swedish females were not significantly different (Hotelling's T^2 test (Bernard, 1981): $T^2 = 3.29$, 3, 112 df, $p > 0.05$). Thus, all females were pooled together and a new growth curve was fitted.

The growth curves and growth parameters for both sexes are shown in Fig. 1 and Table 1 respectively. We observed highly significant differences in growth between males and females ($T^2 = 28.19$, 3, 186 df, $p < 0.01$). Females have a longer growth period than males, the latter attaining the asymptotic length about one year earlier than the former (Figs 1, 2).

DISCUSSION There is little information on growth parameters of the harbour porpoise in the North Atlantic. To our knowledge, accurate information about the growth of this species is only available from the Bay of Fundy (Gaskin and Blair, 1977; Read, 1989).

Our growth curves seem similar to those of Read's (1989) 1985-88 sample. Both males and females from the Bay of Fundy and Scandinavian waters show similar asymptotic lengths, and reach it at about the same ages. Absolute and relative growth for the calves seems higher in the Scandinavian animals, but this may result from considering an additional (0.5 yr) age class.

The results do not conform to a two-cycle growth curve as observed in harbour porpoises from Californian waters (Hohn and Brownell, 1990).

We provide a method to test for differences in growth curves between two samples (sexes, populations, etc.). Although widely used in fisheries science (Moreau, 1987), cetologists do not seem aware of the availability of such methods.

ACKNOWLEDGEMENTS This study was supported by World Wildlife Fund Sweden and the Norwegian Council for Fisheries Research.

REFERENCES

- Bernard, D.R. 1981. Multivariate analysis as a means of comparing growth of fish. *Can. J. Fish. Aquat. Sci.*, 38: 233-236.
- Gaskin, D.E. and Blair, B.A., 1977. Age determination of harbour porpoises, *Phocoena phocoena* (L.), in western North Atlantic. *Can. J. Zool.*, 55: 18-30.
- Hohn, A.A. and Brownell, R.L. 1990. Harbor porpoise in central California waters: life history and incidental catches. Paper SC/42/SM47 presented to IWC Scientific Committee.
- Hohn, A.A. and Lockyer, C. 1990. Report from the harbour porpoise age determination workshop, Oslo 21-23 May 1990. Paper SC/42/SM1 presented to the IWC Scientific Committee.
- Kimura, D.K., 1980. Likelihood methods for the von Bertalanffy growth curve. *Fish. Bull.*, 77: 765-776.
- Kvam, T., Skagen, I., Christensen, I. and Bjørge, A. 1989. Alderbestemmelse av sjøpattedyr. Del 1: Nise. Norsk Institutt for Naturforskning, Forskningsrapport 002.
- Moreau, J. 1987. Mathematical and biological expression of growth in fishes: Recent trends and further developments. Pp 81-113. In *The Age and Growth of Fish* (Editors R.C. Summerfelt and G.E. Hall). Iowa State University Press, Ames.
- Read, A. 1989. *Incidental catches and life history of harbour porpoises (Phocoena phocoena) from the Bay of Fundy*. Ph.D. Thesis. University of Guelph, Canada.

Table 1 Parameters of the Gompertz growth equation ± 1 S.E. and proportion of the variance explained by the model (R^2) of males and females harbour porpoises from Norwegian and Swedish waters.

Sex	Growth parameters			R^2
	A	b	a	
Males	140.1	0.49	1.17	0.85
	± 1.2	± 0.03	± 0.12	
Females	153.4	0.45	0.89	0.90
	± 2.3	± 0.03	± 0.08	

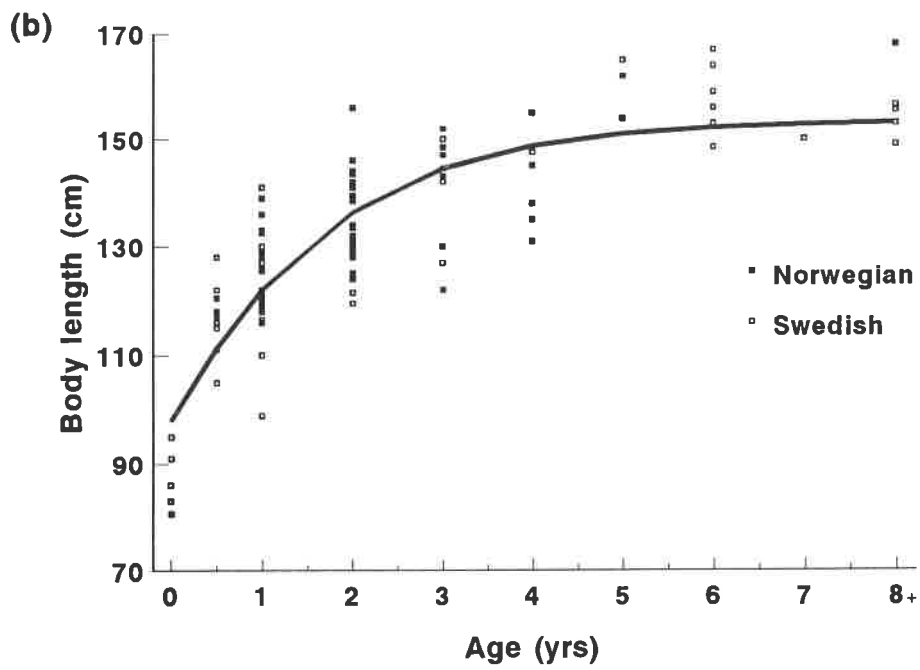
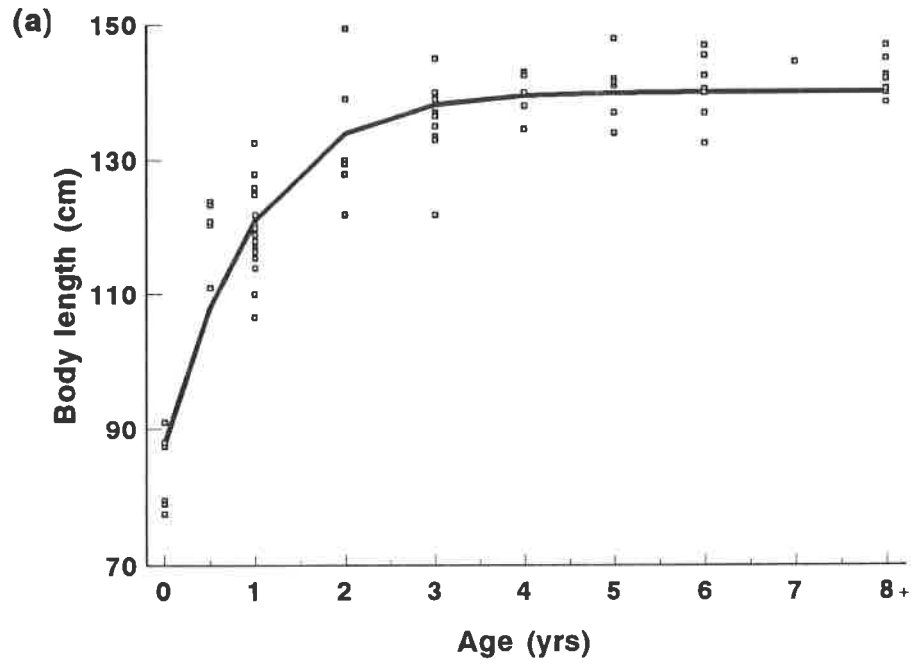

Fig. 1 Gompertz growth curves fitted to length and age data of (a) male and (b) female harbour porpoises from Norwegian and Swedish waters.

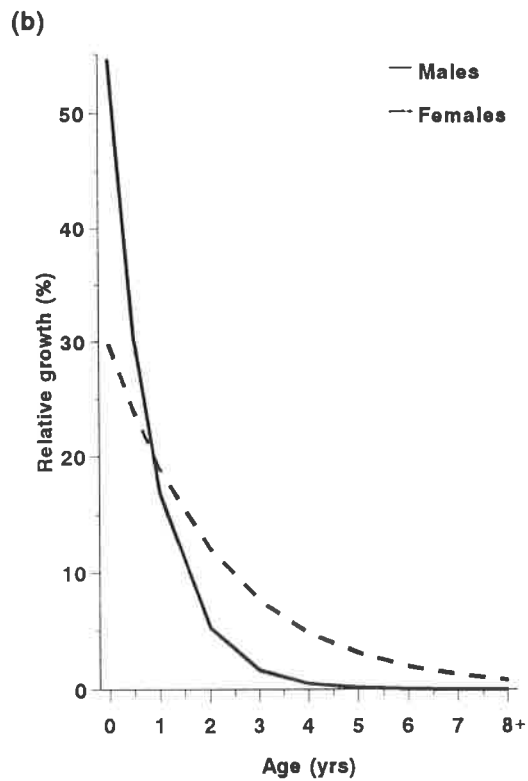
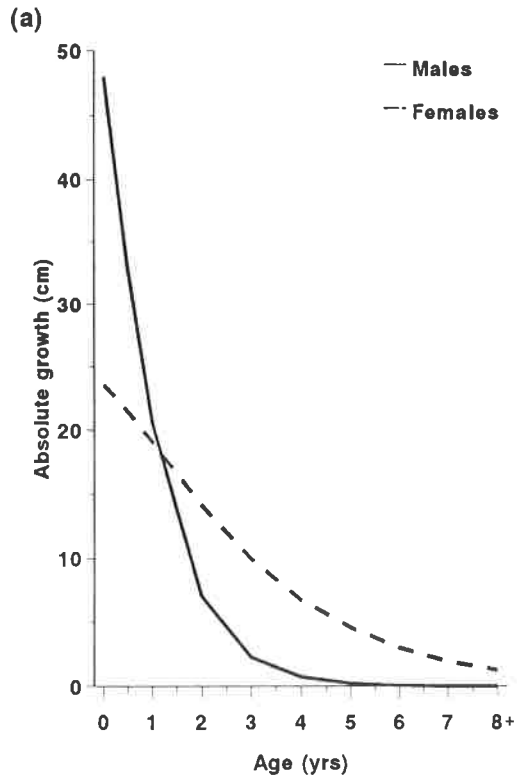

Fig. 2 (a) Absolute and (b) relative growth of male and females harbour porpoises from Norwegian and Swedish waters.

SPATIAL ORGANISATION AND DISTRIBUTION OF SPERM WHALES *PHYSETER MACROCEPHALUS* IN THE SOUTH PACIFIC

Nathalie Jaquet and Hal Whitehead

Biology Department, Dalhousie University, Halifax, NS, Canada B3H 4J1

INTRODUCTION AND OBJECTIVES During the Yankee whaling period (1790-1910), there was already a considerable interest in determining the oceanographic factors influencing sperm whale distribution. For about 120 years, whalers have searched for the "favourite haunts" of sperm whales and have tried to identify the characteristics of the preferred habitat of sperm whales. In the past two decades, in order to improve management and conservation policies, research on sperm whale distribution and spatial organisation has shown a revival of interest. However, the problem of scale can confuse the issue. Several studies seem to have produced contradictory results, mainly because they dealt with different spatial scales.

Therefore, the objectives of this research are to describe the spatial organisation of groups of sperm whales over a wide range of spatial scales; to investigate the relationship between the distribution of sperm whales and environmental and biological variables at different spatial scales; and to examine the importance of food resources in determining spatial organisation.

MATERIALS AND METHODS The data were collected from a 40' sailing boat during a survey around the South Pacific in 1992-93. Sperm whale density was determined by listening every half hour through a hydrophone for their characteristic clicks. The chlorophyll concentration was indicated by a spectral radiometer. Sonar was used to record the intensity of the scattering layer at three different depths (surface: 0-50 m.; medium: 50-300 m.; deep: 300-600 m.). Expendable bathythermographs were used to record temperature profiles to a depth of 600 m. From these, the depth of the thermocline, the maximum difference in temperature within 64 cm depth interval, and the temperature gradient in the first 100 m were extracted.

The spatial organisation of groups of sperm whales was examined by measuring distances between consecutive encounters and then by calculating the rate of finding a new group at different distances from the previous one. To investigate relationships between whale density and biological and environmental variables, the track of the boat was divided into 80 mile segments and a Spearman correlation coefficient was calculated between whale density and each variable. Spatial scale was increased by pulling segments together to obtain 160, 320 and 640 mile segments. The smallest spatial scales (less than 20 miles) were investigated by making measurements of each of the variables every five miles while leaving a group of whales, and then by looking at variations from the mean at different ranges from where the whales were left.

RESULTS AND DISCUSSION Groups of sperm whales were highly clumped, and 80% of the distances between consecutive encounters were less than 160 miles. Figure 1 shows that the maximum rate of finding whales were 10-20 miles and 80-160 miles from previous encounters. This result suggest that groups of whales formed aggregations in which the groups are less than 20 miles apart and that these aggregations are clumped to form concentrations in which each of them are separated by 80 to 160 miles (Fig. 2). The areas occupied by these concentrations were roughly 300 miles across.

To investigate whether there were any biological or environmental factors which characterised the water in which whales formed concentrations or aggregations, Spearman correlation coefficients were calculated between whale density and each of the variables on each spatial scale. There was never any significant correlation between whale density and

any temperature parameters, chlorophyll concentration, or intensity of the surface scattering layer, at any spatial scale. However, there was a significant correlation between whale density and the intensity of the medium and deep scattering layer at spatial scales greater than 80 miles. The strongest correlation was found at a spatial scale of 320 miles (Fig. 3), suggesting that the amount of biomass between 50 and 600m deep was higher within the concentrations than in adjacent waters.

There were no consistent variations of any of the biological or environmental factors while leaving a group of whales (spatial scale of 20 miles). This suggests that the sea areas in which groups of whales formed aggregations were no different from surrounding water within the concentration.

In conclusion, this work shows that groups of whales formed aggregations over a spatial scale of approximately 30 x 30 miles and that within these aggregations, the groups seem to be randomly distributed. There was no evidence that the water within these aggregations was any different from surrounding waters. The aggregations were clumped into concentrations over a spatial scale of approximately 300 x 300 miles. The aggregations seems to be randomly distributed within these concentrations. It was found that the amount of biomass between 50 and 600 m deep was higher within these concentrations than in adjacent waters, suggesting that whales are clumped into concentrations because of increased feeding opportunities (Table 1).

Table 1 Summary of sperm whales' spatial organisation

Agglomeration of whales	Approximate Spatial scale	Type of spatial organisation within the agglomeration	Remarks
groups	2 X 2 n.m.	- clumped - spaced (rank)	→ social → coordinated feeding
Aggregations	30 X 30 n.m.	random??	no evidence of more productive water → ??
Concentrations	300 X 300 n.m.	random??	deep water biomass higher than in adjacent areas → food
Oceans	10,000 X 10,000 n.m.	clump	mainly in upwelling areas → food

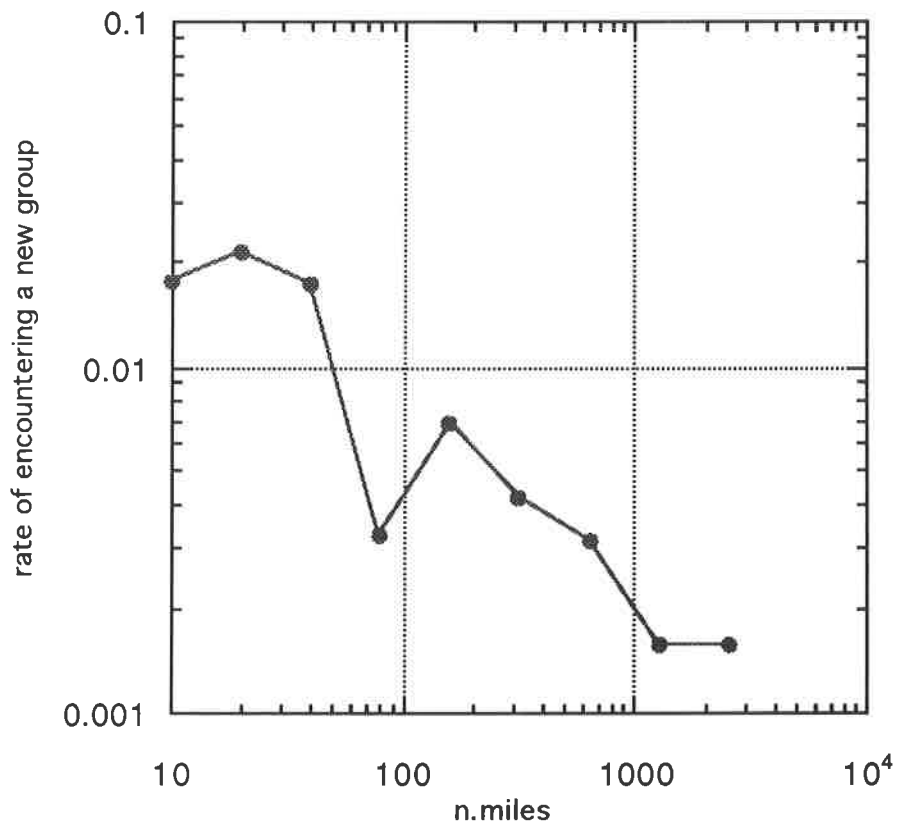

Fig 1 Rate of encountering a new group at different ranges from the previous one

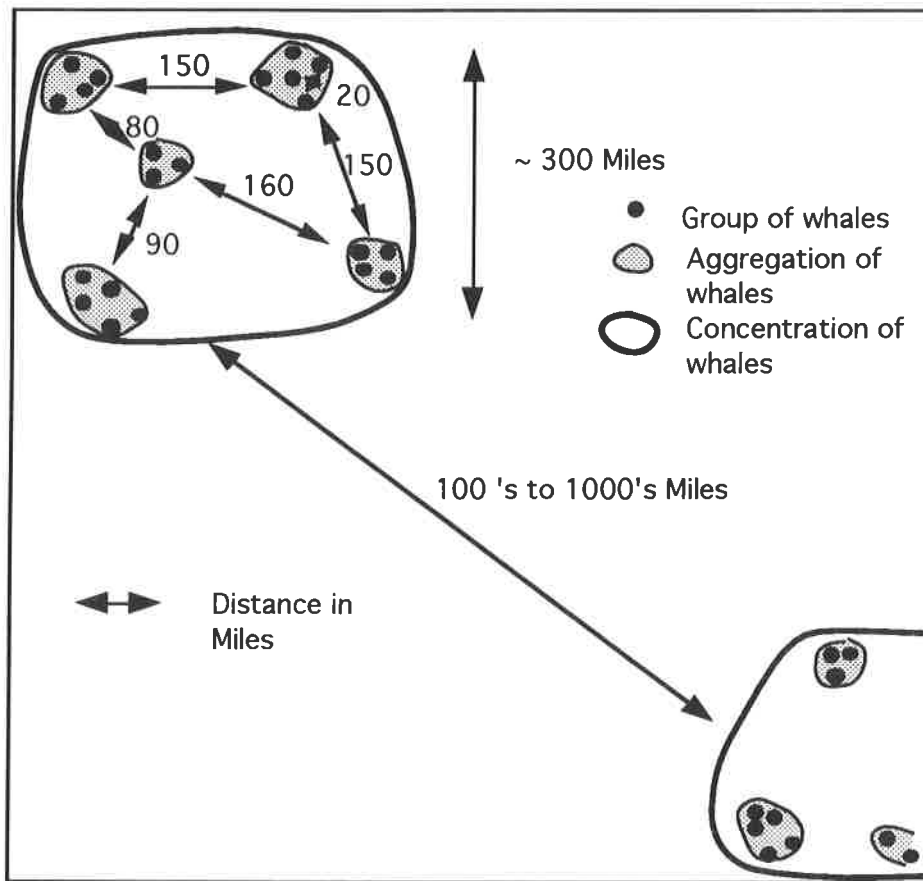

Fig. 2 Spatial organisation of groups of female and immature sperm whales

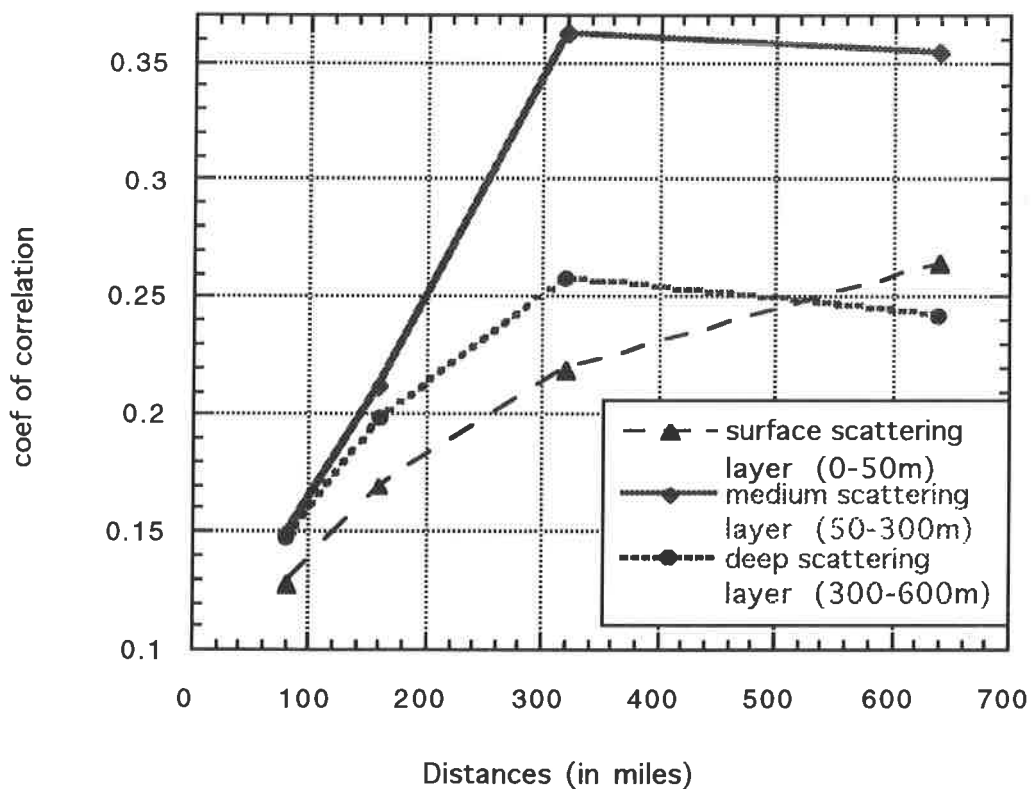

Fig. 3 Spearman correlation coefficients between whale density and intensity of the scattering layers

**THE CONTEXTUAL NATURE OF UNDERWATER BEHAVIOUR
AND VOCALISATIONS IN ATLANTIC SPOTTED DOLPHINS
*STENELLA FRONTALIS***

Denise L. Herzing

Florida Atlantic University, Biological Sciences,
Boca Raton, Florida 33431, USA

INTRODUCTION Understanding the development of social interaction in mammals has been accomplished by observing individuals through their life history patterns and in natural social contexts (Goodall, 1986). Sources of information, other than the signal itself, including age, gender, reproductive status, signals simultaneously emitted in other modalities, audience, and relationships with conspecifics are included in the definition of context (Smith, 1986). Social interaction with a multi-generational and gendered society, including agonistic and play encounters, is critical for social development and communicative skills in mammals (Bekoff, 1972). This paper describes underwater vocalisations and behavioral correlations and their relationship to the developmental aspects of dolphin society.

METHODS One hundred resident Atlantic spotted dolphin (*Stenella frontalis*) were observed for five months each summer, between 1986 and 1993, to provide a cultural framework for the study of delphinid communication. Individual fins, flukes, and changing spot patterns were tracked through underwater still and video photography. These resident dolphins inhabited an offshore, shallow sandbank and its adjacent deep waters off Grand Bahama Island in the Bahamas. Underwater observation periods varied from five minutes to four hours, with an average duration of 20 minutes. Behaviours and vocalisations were simultaneously recorded using an underwater video with direct hydrophone input, and processed with a Mac 11ci and digital sound processing board. Age classification included neonate/infants (two-tone): birth-3 years; juveniles (speckled): 4-8 years; young adults (mottled): 9-15 years; and old adults (fused): 15 years or more. Coefficients of association (COA) were calculated for individual dolphins over the years.

RESULTS Seven types of vocalisations including the signature whistle, excitement vocalisation, genital buzz, squawk, scream, bark, and synchronised squawk were correlated with underwater behavioural activity and are described by their spectral, behavioural, and contextual components (Table 1). The function of vocalisations varied by gender, age, and behavioural activities.

Changes in association and behaviour were observed as dolphins matured or changed reproductive status during ages eight and twelve (Fig. 1). For females, changes in COA were correlated with babysitting or alloparental care (age 8) and courtship activity and changing reproductive status (age 12). For males, changes in COA were correlated with coalition formation (age 8) and courtship activity (age 12).

CONCLUSION Tracking the yearly development of individual dolphins, including male coalitions, alloparental care, mating strategies, disciplinary roles, and interspecific interactions with bottlenose dolphins (*Tursiops truncatus*) were critical to the assessment of the function of communication signals. Integrated social species are characterised by cohesiveness, role sharing, and complex communication that is often subtle but expressive, and understanding the nuances and contextual meanings of these signals may require larger contextual frameworks. Underwater observations in the wild may provide opportunities to observe signals within their natural environment and social contexts.

REFERENCES

Bekoff, M. 1972. The Development of Social interaction, Play, and Metacommunication in Mammals: an ethological perspective. *Quart. Review Biol.*, 47:412.

Goodall, J. 1986. *The Chimpanzees of Gombe: patterns of behavior*. Harvard University, Cambridge, MA. 673 pp.

Smith, W.J. 1986. Signaling Behavior: Contributions of Different Repertoires. Pp. 315-333. In *Dolphin Cognition and Behavior: a comparative approach*. (Editors R.G. Schusterman, J.A. Thomas and F.G. Wood). Lawrence Erlbaum Associates: Hillsdale, NJ. 393 pp.

VOCALIZATION TYPE	SPECTRAL DESCRIPTION	BEHAVIORAL CONTEXT	AGE CLASS AND GENDER OF VOCALIZER
Signature Whistle	Frequency modulated whistle 4 - 18 kHz .5 - 5 second duration Bubbles emitted from blowhole occasionally	Mother/infant reunions	All age classes Female and male offspring
		Foraging expeditions with infants	Juvenile, young and old adults Female/male
		Courtship	Females/Males
Excitement Vocalization	Burst - pulsed vocalization w/overlapping signature whistle 4 - 18 kHz 2 - 30 second duration Bubbles emitted from blowhole	Distress or excitement	All age classes Most frequently infants Females/males
Genital Buzz	High rate echolocation clicks 1.2 kHz - 2.5 kHz 8 - 2000 clicks/second 6 - 20 second duration	Courtship	Juvenile, young, and old adults Males
		Discipline	Old adult Females Mothers
Squawk	Broad - band burst - pulsed vocalization .2 - 12 kHz .2 - 1.0 second duration 200 - 1200 clicks/second	Agonistic and Aggressive Intra and Interspecific	All age classes Females/males
		Sexual Play Intra and Interspecific	All age classes Males
		Courtship Rejection	All age classes Females/males
Scream	Overlapping FM whistles 5.8 - 9.4 kHz 2.5 - 4.0 second duration	Agonistic and Aggressive Intra and Interspecific	Juvenile, young and old adults Males
Bark	Burst - pulsed vocalization .2 - 2.0 kHz .5 - 1.0 second duration	Agonistic and Aggressive Interspecific	Juvenile, young and old adults Males
Synchronized Squawks	Burst - pulsed vocalization .1 - 15 kHz Max energy .1 - 2.2 kHz .9 - 1.0 second duration	Agonistic and Aggressive Interspecific	Juvenile, young and old adults Males

Table 1 - Vocalizations and correlated behavioral contexts for *Stenella frontalis*.

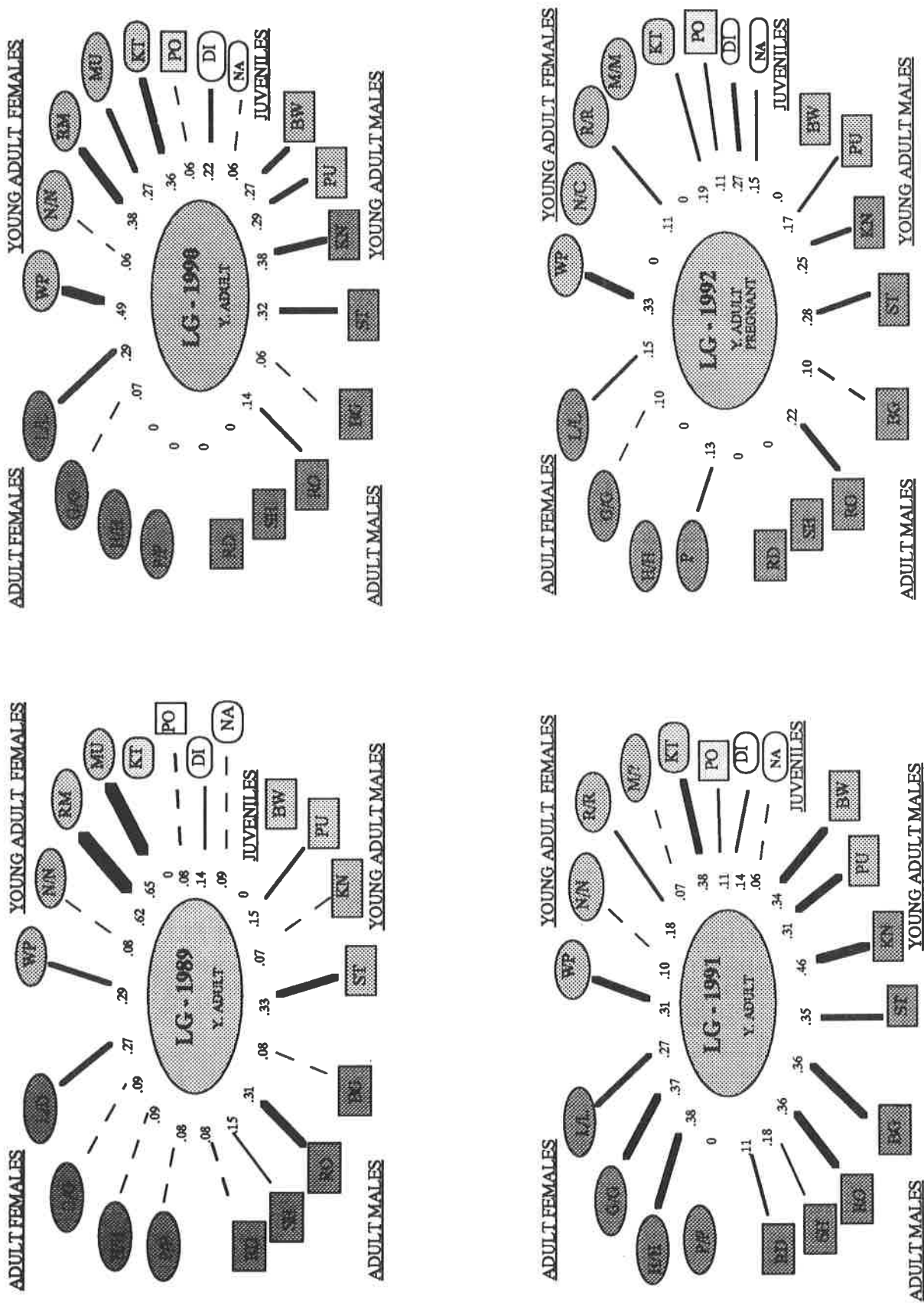

FIG. 1 - Coefficient of association for one female, LG, 1989-1992, with four dolphins in each age class. COA is displayed numerically and by the thickness of the line. Females are circles, males are squares. Letters with slashes are mothers/infants. Degree of shading represents degree of spotting.

**VOCAL PATTERN OF TWO CAPTIVE MALE
BOTTLENOSE DOLPHINS *TURSIOPS TRUNCATUS***

Barbara J. Brunnick

Wild Dolphin Project, 21 Hepburn Avenue Suite 21,
Jupiter, Florida, 33458, USA

This investigation demonstrates distinct patterns in the vocal activity of two bottlenose dolphins (*Tursiops truncatus*), in captivity, over a two year period. These patterns change in overall number and intensity between years, but remain consistent in form over 24-hour periods. Influences on these patterns include natural diurnal effects and human-induced activities. These influences diversely affect a small group of specific vocal categories.

Patterns in activity during the daytime have a direct relationship to Feed and Training sessions. Variations in patterns associated with vacuum sessions and the physical orientation of the *Tursiops* spp. on Pacific white-sided dolphin (*Lagenorhynchus obliquidens*) suggest a degree of adaptation.

There were three specific vocal events that remained consistent over time and had no obvious relationship to human activity. These events, occurring at 04:00, 06:00 and 18:00 hrs, have a limited association to light/dark cycles. The early morning vocal patterns oscillate in number of vocalisations produced, until a peak during the morning chorus.

There is a steady pattern of non-activity that is associated with photic and sleep cycles.

FEATURE EXTRACTION ANALYSIS OF DOLPHIN WHISTLES

S. Mahadevan, S. Datta and A. D. Goodson

Signal Processing Research Group - Bioacoustics & Sonar,
Electronic & Electrical Engineering Department,
Loughborough University of Technology,
Ashby Road, Loughborough, Leicestershire LE11 3TU, UK

INTRODUCTION Experiments to test dolphin/gill-net deterrent devices with the wild bottlenose dolphin population in the Moray Firth during three successive trials between 1991-93 have accumulated a very large database of underwater recordings of these animal's vocalisations. The major part of dolphin vocalisations fall into two categories. The first, which carries no obvious identity characteristics, are the sequences of broad band transients (click) primarily used in echolocation (Nachtigall, 1980). The second type of vocalisation comprises an extended narrow band frequency modulated 'whistle' (between 2 and 20 kHz) which may continue for over 1 second. These whistles appear individually distinctive and repeat certain acoustic features. Hence they were called whistle 'signatures' (Caldwell and Caldwell, 1990). The accumulated tape library includes numerous whistles sampled from the Moray Firth population which is believed to exceed 100 different animals. Although the analysis of this database has been directed towards the extraction of echolocation behaviours it is now desirable to try to identify individuals in order to determine whether their detection/avoidance behaviour within the experimental zone is the result of prior experience or is a naive reaction. It seems obvious that the detection/avoidance behaviour of the animals will be biased by a previous experience (Mayo and Goodson, 1992). As the test zone comprises a kilometre square, conventional photo-identification techniques have proved impractical since the photographers cannot be placed sufficiently close to these animals without disturbing their behaviour.

A very large number of whistles from this database have been sampled and displayed using a spectrographic speech workstation. However the number of possible individuals makes the isolation of key features for individual identification quite difficult. To run a controlled experiment, recordings of four captive bottlenose dolphins (Dolphin 1, 2, 3 & 4), have been analysed, since in this case the identity of each source could be determined. This paper discusses the features which may be most easily extracted from these whistles.

ACOUSTIC STRUCTURE OF THE WHISTLE That the "Whistle like squeak" of the bottlenose dolphin is used in a communication context was noticed as early as 1956 (Schevill and Lawrence, 1956). Whistles of most dolphins show great variations in frequency (Caldwell and Caldwell, 1990), duration (Kellogg, 1953, 1961) and other acoustic features. Each dolphin appears to produce a specific contour and a specific pattern of frequency modulations which are believed to be individually distinctive. The identification of whistles should provide a clue to the presence of an individual animal and may be observed unobtrusively at quite long range. Buck and Tyack (1993) presented a computationally intensive algorithm for use as a quantitative measure of similarity between signature whistles of bottlenose dolphins. This sophisticated signal processing approach appears less useful when pre-processing large quantities of data, especially in the field with restricted computer facilities. The approach taken here has been to look for simple features that may be extracted automatically with a minimum of computation in order to aid the development of a near-real-time 'pre-classifier' that can isolate and code 'similar' signals for later off-line examination.

MATERIALS AND METHODS Most recordings were made at a tape speed of 7.5 ips using a Racal Store 4DS instrumentation recorder. A linear (EBU) time code was continuously written on one of the channels. The captive animal signals were recorded from HS70 ball hydrophones via wideband preamplifiers onto two channels and a voice log

of events maintained on the fourth. In the laboratory, the timecode was displayed and used to identify each whistle analysed. The recorded signal data was played back through an adjustable band-pass filter, set to remove water and interference noises below 2 kHz, and coupled via a precision attenuator to a colour spectrograph (Loughborough Sound Images Speech Work Station). The output from the attenuator was also connected to an amplifier and monitor loudspeaker in order to listen to the sounds. 106 whistles from the four dolphins were sampled, analysed, and displayed on the workstation. Simple classification features such as: the frequencies spanned ($f_{\text{end}}-f_{\text{start}}$), the rate of change of frequency (Δf), number of frequency reversals (nf_{REV}), harmonic structures (f_{h2-n}), and duration (t) were studied. A number of other features such as the amplitude variations (A) occurring within a whistle were also examined. This formed the (manual) feature extraction stage for the cluster analysis carried out later.

CLUSTER ANALYSIS - RESULTS AND DISCUSSION The data obtained was loaded into a 386 PC running Windows with Cricket Graph for graphical analysis. Although most of the parameters taken in isolation provided inadequate identification clues, good clustering was apparent with certain combinations (see Figure 1). Of the basic features, whistle duration was one factor which provided a strong discriminating factor for the four animals. Rate of change in frequency ($\Delta F/t$), and nf_{REV} were also strong discriminating features. In combination, these parameters produce four distinct clusters correlating well with the known identity of the four test animals. The whistles of dolphins 1 & 2 rise steadily in a single sweep from below 5 kHz to an upper limit nearing 18 kHz or over, without frequency reversals or "loops" in the whistle ($0f_{\text{REV}}$). The $\Delta F/t$, however, was faster in dolphin 1 than dolphin 2. The whistle of the second dolphin was consistently longer in duration than the first. Whistles of dolphin 3 were of longer duration than 1 or 2 but rarely as long as dolphin 4. Dolphin 3 nearly always exhibited two or three frequency reversals ($2f_{\text{REV}}$ or $3f_{\text{REV}}$). Whistles of dolphin 4 were of the longest duration in the set and consistently exceeded $3f_{\text{REV}}$ whilst including additional harmonic structures towards the end of the signal. A representative set of four spectrograms is depicted in Figure 2.

CONCLUSIONS Since visually it has proved easy to distinguish each animal's signal from the spectrogram image alone, the result of the cluster analysis approach seems to demonstrate that, in combination, very elementary classifiers serve to adequately distinguish these four animals. Such simple combinations can be extracted by relatively unsophisticated algorithms when aided by hardware pre-processing, and the goal of fast (real-time) automatic recognition by a portable computer operating in the field should be realisable without the necessity of the high speed DSP processor techniques that more sophisticated signal analysis correlation methods require. The approach will now be applied with appropriate hardware to the tape library data and, if successful, will eventually be used to support further field trials on-line. One target is the calculation of a numeric ID vector computed from the extracted classifiers that could be written back to the logging channel of the instrumentation recorder immediately after processing each whistle.

REFERENCES

- Buck, J. R. and Tyack, P. L. 1993. A quantitative measure of similarity for *Tursiops truncatus* signature whistles. *J. Acoust. Soc. Amer.*, 94(5): 2497-2506.
- Caldwell, M. C. and Caldwell, D. K. and Tyack, P. L. 1990. Review of the Signature Whistle Hypothesis for the Atlantic bottlenose dolphin. Pp. 199-234. In *The bottlenose dolphin*. (Eds. S. Leatherwood and R. Reeves). Academic Press Inc. New York.
- Kellogg, W. N., Kohler, R. and Morris, H. N. 1953. Porpoise sounds as sonar signals. *Science*, 117: 239-243.
- Kellogg, W.N. 1961. *Porpoises and sonar*. University of Chicago Press, Chicago.

Mayo, R.H. and Goodson, A.D. 1992. Interaction between wild dolphins and a moored barrier; Initial results from the 1991 Moray Firth trial. In *European Research on Cetaceans - 6 Proc. 6th Ann.Conf. ECS, San Remo, Italy.* (Ed P.G.H.Evans). European Cetacean Society, Cambridge, England.

Nachtigall, P.E. 1980. Odontocete echolocation performance on object size, shape and material. Pp. 1029-1069. In *Animal Sonar systems* (Eds. R. G. Busnel and J. F. Fish). Plenum, New York.

Schevill W.E. and Lawrence B. 1956. Food finding by a captive porpoise (*Tursiops truncatus*). *Breviora*, 53: 1-15.

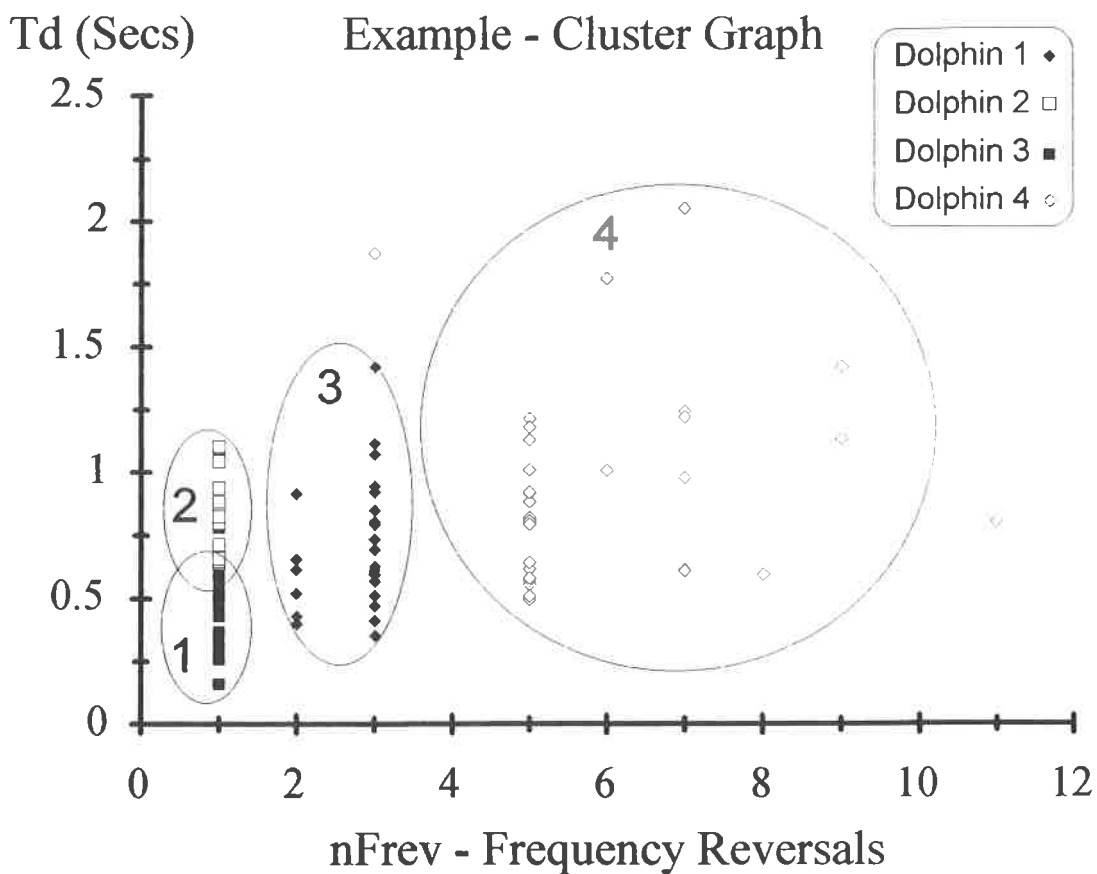
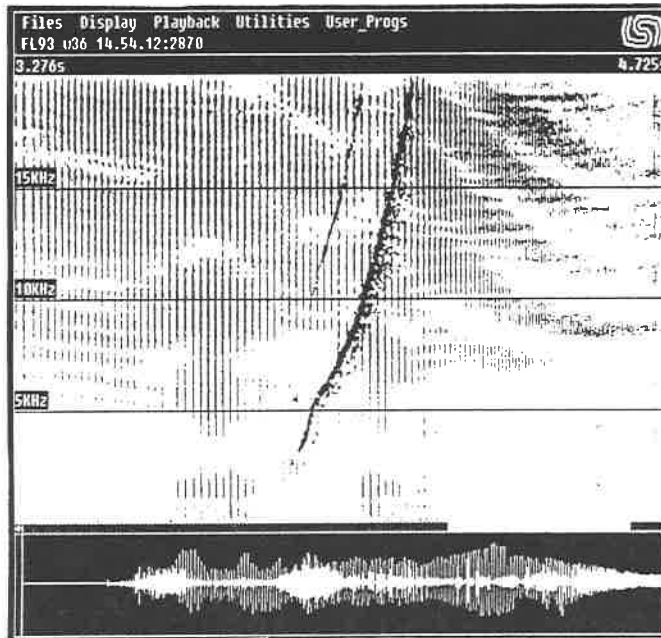
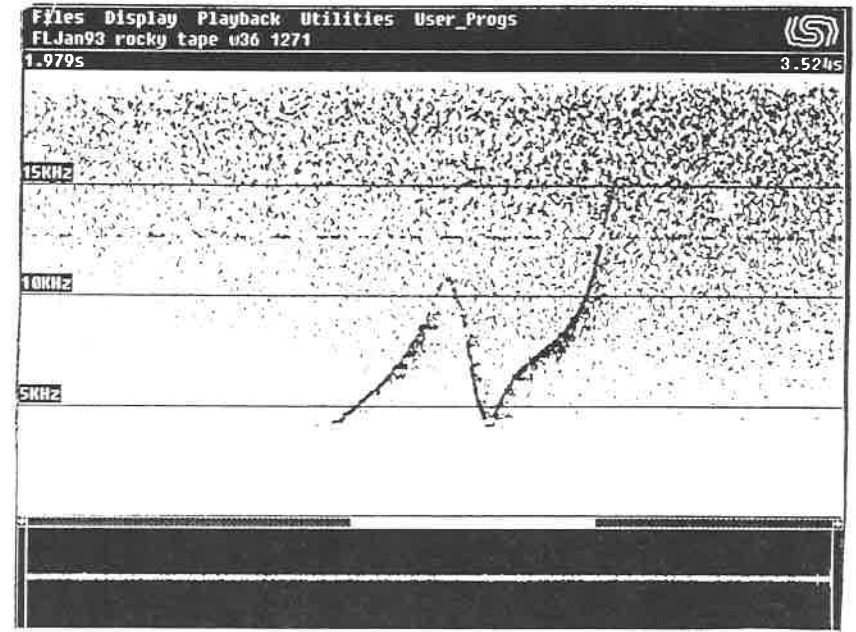

Fig. 1 Example of clustering of whistle features for four dolphin individuals



Dolphin 1 : Betty



Dolphin 3 : Sharky

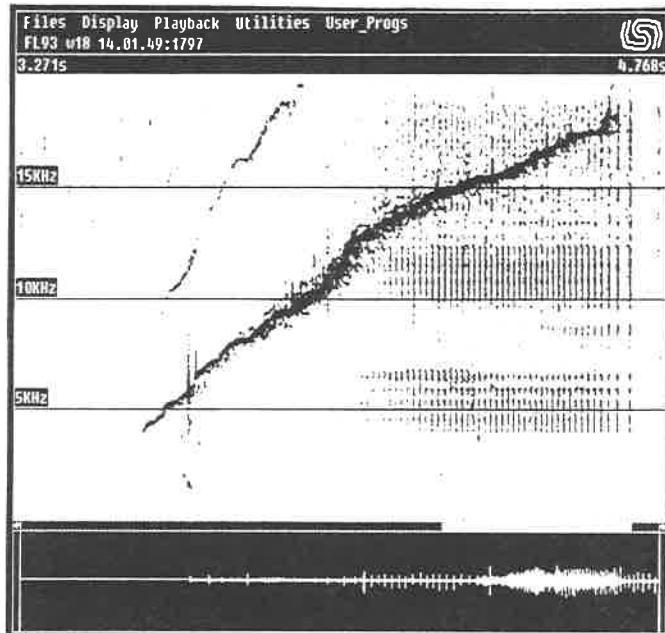

Dolphin 2 : Lotty

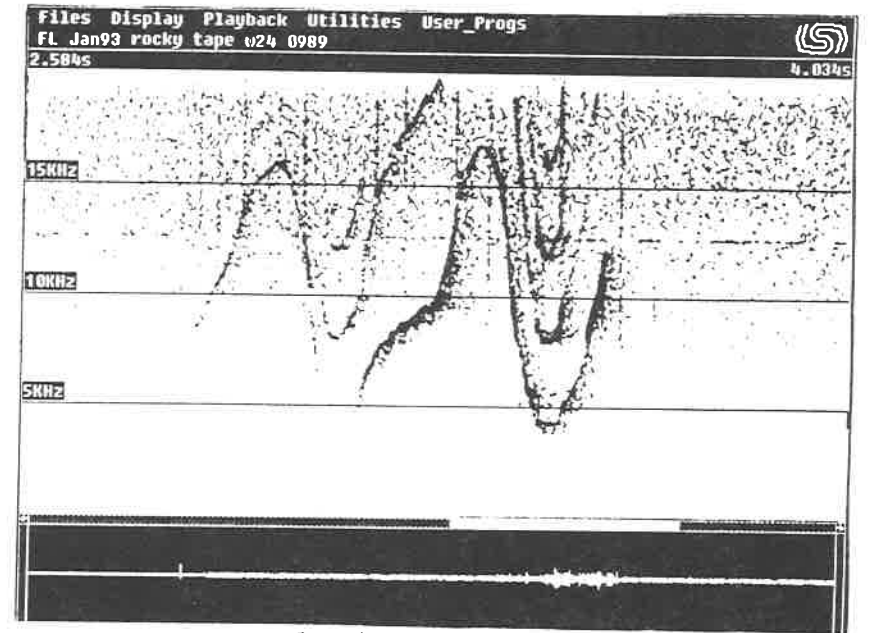

Dolphin 4 : Rocky

Figure 2 : A representative set of four spectrograms.
(one each from each of the animal described)

A REVIEW OF ECHOLOCATION RESEARCH ON THE HARBOUR PORPOISE *PHOCOENA PHOCOENA* AND THE COMMON DOLPHIN *DELPHINUS DELPHIS*

C.R. Sturtivant, S. Datta and A.D. Goodson

Electronic and Electrical Engineering Department,
Signal Processing Research Group – Bioacoustics & Sonar,
Loughborough University of Technology, UK

INTRODUCTION The design of passive acoustic deterrents to mitigate the problem of small cetacean bycatch in commercial gillnets requires detailed knowledge of the echolocation characteristics of the species at risk. In UK waters, the cetaceans perceived to be at greatest risk are the harbour porpoise (*Phocoena phocoena*), and the common dolphin (*Delphinus delphis*).

In order better to understand the acoustic detection problems faced by these species in the context of fishing gear, a search of published literature was undertaken for quantitative and qualitative data on their echolocation abilities. Although much data have been reported on echolocation for the bottlenose dolphin (*Tursiops truncatus*), much less exists for *Phocoena*, and data for *Delphinus* remains poorly documented. Many of the references found for *Delphinus* cite work from the former Soviet Union, reported in Russian. Reported research on this species has been found in reviews, which have provided the only source of information.

Physical acoustic limitations, and the comments of Dierks *et al.* (1973) and Watkins (1974) when examining the difficulties inherent in measurement of high frequency echolocation signals, have been considered when interpreting the data presented here.

LITERATURE ON *PHOCOENA* Amundin *et al.* (1988) reported *Phocoena*'s vocal repertoire as consisting exclusively of clicks, which exhibit a relatively narrow bandwidth (11 to 19 kHz) centred between 125 and 140 kHz (Hatakeyama and Soeda, 1990). Evans (1973) commented upon the "monochromatic" nature of *Phocoena*'s echolocation signal, suggesting that its sonar is primarily used for target detection since insufficient signal bandwidth exists to enable classification of targets to take place on spectral "coloration" of echoes. Amundin (1991b) suggested its specialised sonar and absence of FM signals may have developed due to the needs of the coastal habitat outweighing the consequent restrictions in vocal communication.

Andersen (1970) measured a behavioural audiogram for *Phocoena*, where he noted an ability to detect sounds in the range 1 kHz to 150 kHz (Figure 1). However, rather different results were recorded by Voronov and Stosman (1986) for a *Phocoena* brain-stem audiogram (Figure 2). This shows an evoked potential sharply tuned to those frequencies in the echolocation signal band (120 kHz to 140 kHz). Similar high frequency evoked potentials matching the echolocation spectrum were noted for *Platanista indi* and *Inia geoffrensis*. The significant differences in response from these alternative methodologies support the concept of a separate receptor optimised for echolocation. The sonar receptor response appears to have been measured by Voronov and Stosman, whereas Andersen has assessed the animal's overall sensitivity to sound pressure.

The Source Level and peak frequencies of sonar signals for *Tursiops* are seen to be affected by reverberation level of the environment and to a lesser extent by background noise, unless this contains high frequency components (Au *et al.*, 1974). Similarly, recordings of *Phocoena* by Akamatsu *et al.* (1992) which were carried out in low reverberant conditions, showed Source Levels up to 177 dB re 1 μ Pa at 1 m. These exceed those previously reported by almost 20 dB, where reverberation levels were higher.

LITERATURE ON *DELPHINUS* *Delphinus* was noted by Evans and Awbrey (1988) as vocal during the day, producing whistles, click trains and squeals, with echolocation click trains predominating at night. *Delphinus* generally forages on squid and small schooling fish around 20 cm in length, including sardines, anchovies, herring and pilchards, and in some areas, organisms from the deep scattering layer which have risen towards the surface at night (Jefferson and Leatherwood, 1990).

Delphinus's hearing range was measured by Bel'kovich and Solntseva (1970) (cited in Wood and Evans, 1980) as from 100 Hz to 280 kHz, with maximum auditory sensitivity in the 60 kHz to 100 kHz region, although Wood and Evans did not specify whether the values were behavioural or brain-stem responses and did not indicate the relative sensitivities recorded.

Delphinus echolocation signals tend to have multi-modal spectra, with strong peaks in the ultrasonic range (Evans and Awbrey, 1988). However, Wood and Evans (1980) showed an echolocation waveform and associated spectrum depicting significant energy in the 10 kHz to 40 kHz region, peaking at 25.6 kHz, with lesser peaks at 90 kHz and 110 kHz. It appears that these data were probably obtained from captive Soviet animals, and if this is the case, it seems likely that open water recordings may detect higher dominant frequencies.

Gurevich (1969), cited in Evans (1973), calculated a Source Level for *Delphinus* to be 140 dB re. 1 μ Pa at 1 metre. If this value is indicative of a typical foraging Source Level, it would place *Delphinus* echolocation clicks some 30 dB quieter than those of *Phocoena*. This appears rather unlikely for an animal almost twice the size of *Phocoena*, and it seems more probable that either an enclosed experimental environment imposed a reverberation limit (which encouraged the animal to use quieter clicks), or that a limited frequency response in the recording equipment (circa 1960) led to these results. Alternatively, the recording hydrophone may not have been deployed on the centre axis of the animal's transmission.

CONCLUSIONS It appears that *Phocoena*'s small physical size may influence its maximum echolocation Source Level. Its small head size defines a limited acoustic aperture and hence a wide beamwidth, low Directivity and low Source Level. The narrow bandwidth signal transmission may compensate to some extent by improving the signal to noise ratio of returning echoes and enabling detection of small objects at longer range, but this in turn may impair early target classification. *Phocoena* appears as an opportunistic feeder, spending much of its time foraging near the sea bed (Wood and Evans, 1980; Hohn, 1990). The harbour porpoise sonar appears optimised for the detection and interception of small prey at short range.

Delphinus appears catholic in its choice of prey, but employs an echolocation signal with a much wider spectrum than *Phocoena*. This wideband sonar may enable it to recognise features from the "coloration" of the target's echo (as these are affected by differences in the target's size, swim-bladder shape and volume), and aid the discrimination of prey from non-prey objects soon after detection. *Delphinus*'s discrimination capabilities have been compared favourably with those of *Tursiops* (Nachtigall, 1980), which uses peak frequencies higher than those reported for *Delphinus*.

In summary, the authors suggest that the data on Source Levels and frequency spectra for *Delphinus* have been underestimated in the literature examined. We would expect that the low reverberation pelagic environment would permit and encourage the use of significantly higher Source Levels. This species' acoustic capabilities have not been adequately studied to date, and it is hoped that more attention will be accorded to it since it appears particularly vulnerable to bycatch in a variety of commercial fisheries.

REFERENCES

- Akamatsu, T. *et al.* 1992. Process of Harbour porpoises' entanglement in the gill net. Technical Report of N.R.I.F.E., pp. 25-36 (in Japanese).
- Amundin, M., Kallin, E., and Kallin, S. 1988. The study of the sound production apparatus in the Harbour porpoise, *Phocoena phocoena*, and the Jacobita, *Cephalorhynchus commersoni*, by means of serial cryo-microtome sectioning and 3-D computer graphics. In *Animal Sonar, Processes and Performance*: 61-66.
- Amundin, M. 1991. *Sound production in odontocetes with emphasis on the Harbour porpoise Phocoena phocoena*. Doctoral dissertation, University of Stockholm.
- Andersen, S. 1970. Auditory sensitivity of the Harbour porpoise *Phocoena phocoena*. *Investigations on Cetacea*, 2: 255-259.
- Au, W. W. L., Floyd, R. W., Penner, R. H., and Murchison, A. E. 1974. Measurement of echolocation signals in the Atlantic Bottlenose dolphin, *Tursiops truncatus* Montagu, in open waters. *Journal of the Acoustical Society of America*, 56(4): 1280-1290.
- Bel'kovich, V.M., and Solntseva, G.N. 1970. Anatomy and function of the ear in the dolphin. *Zoologicheskii Zhurnal*, 49(2):275.
- Dierks, K.J., Trochta, R.T., and Evans, W.E. 1973. Delphinid sonar: Measurement and analysis. *Journal of the Acoustical Society of America*, 54(1): 200-204.
- Evans, W.E. 1973. Echolocation by marine delphinids and one species of freshwater dolphin. *Journal of the Acoustical Society of America*, 54(1): 191-199
- Evans, W.E, and Awbrey, F.T. 1988. Natural history aspects of marine mammal echolocation: Feeding strategies and habitat. Pp. 521-534. In *Animal Sonar, Processes and Performance*.
- Gurevich, V.S. 1969. Echolocation discrimination of geometric figures in the dolphin, *Delphinus delphis*. Hatakeyama, Y. and Soeda, H. 1990. Studies on echolocation of porpoises taken in salmon gillnet fisheries. Pp. 269-281. In *Sensory Abilities of Cetaceans, Laboratory and Field Evidence*.
- Hohn, A.A. 1990. Harbour porpoise. Pp. 170-171. In *Whales and Dolphins* (Ed. A.R. Martin). Salamander Books Ltd., London.
- Jefferson, T.A. and Leatherwood, S. 1990. Common dolphin. Pp. 146-147. In *Whales and Dolphins* (Ed. A.R. Martin). Salamander Books Ltd., London.
- Nachtigall, P.E. 1980. Odontocete echolocation performance on object size, shape and material. Pp. 71-95. In *Animal Sonar Systems*.
- Titov, A.A. 1972. *Investigation of the sound activities and peculiarities of the Black Sea dolphin's echolocator*. PhD Thesis, Karadag (In Russian)
- Voronov, V.H. and Stosman, I.T. 1986. Electrical responses of the stem structures of the acoustic system of *Phocoena phocoena* to tonal stimuli. In *The Electrophysiology of the Sensory Systems of Marine Mammals*. (Ed. V.E. Sokolov). Nauk, Moscow (in Russian)
- Watkins, W.A. 1974. Bandwidth limitations and analysis of cetacean sounds, with comments on "Delphinid sonar: Measurement and analysis" [K.J. Diercks, R.T. Trochta, and W.E. Evans, *J. Acoust. Soc. Am.* 54, 200-204 (1973)]. *Journal of the Acoustical Society of America* 55(4): 849-853
- Wood, F.G. and Evans, W.E. 1980. Adaptiveness and Ecology of Echolocation in Toothed Whales. Pp. 381-425. In *Animal Sonar Systems*.

Table 1 Ultrasonic Sound Production in harbour porpoise and common dolphin

	<i>Phocoena phocoena</i>	<i>Delphinus delphis</i>
Peak frequencies	2 kHz and 125-140 kHz (Hatakeyama and Soeda 1990)	20 kHz - 100 kHz* (Titov 1972)
Click duration	29-83 μ sec (Hatakeyama and Soeda 1990)	35-350 μ sec* (Evans 1973)
Source Level (re. 1 μ Pa at 1 metre)	149-177 dB (Akamatsu <i>et al.</i> 1992)	140 dB* (Gurevich 1969)

The values given for *Delphinus* (marked with an asterisk * in the table) should be treated with caution. The wide range in the peak frequency and click duration, and the low value for the source level, suggest either deficiencies in the recording apparatus used, or recordings made outside the main beam of the animal.

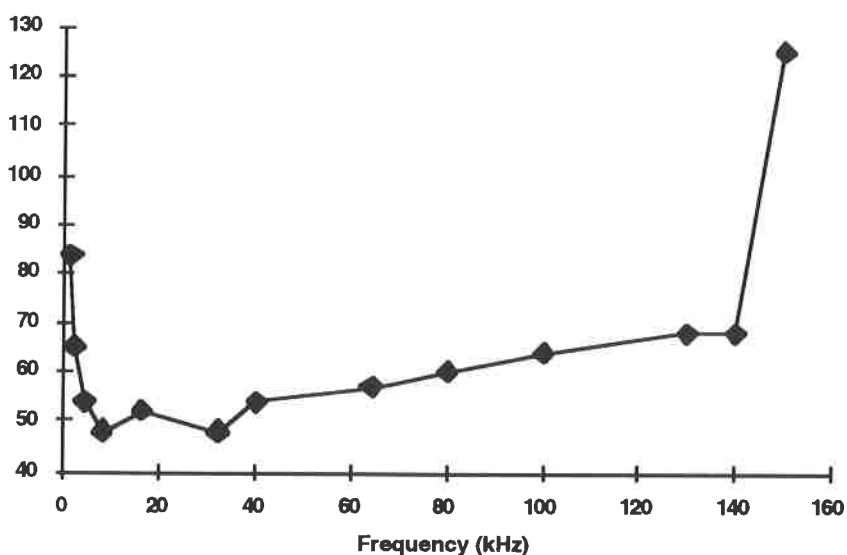

Figure 1 *Phocoena phocoena* behavioural audiogram
(taken from data presented in Andersen 1970)

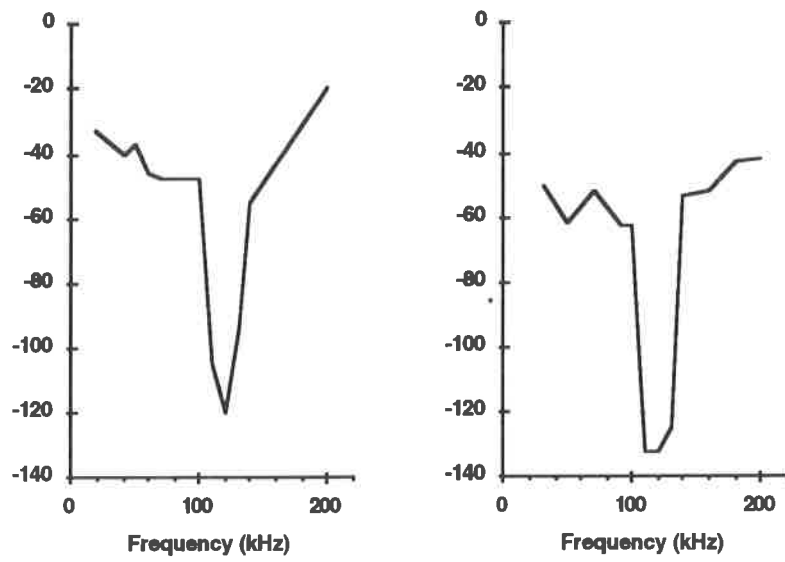

Figure 2 Frequency thresholds for two Azov Sea Harbour porpoises (*Phocoena phocoena*) taken from data in Evans 1988 (Voronov & Stosman 1986)

**HARBOUR PORPOISE ACOUSTIC SURVEYING METHODS:
DEVELOPMENT OF EQUIPMENT FOR AUTOMATIC RECOGNITION
AND COMPUTERISED LOGGING OF VOCALISATIONS.**

Oliver Chappell, Chappell Hydrophones, c/o International Fund for Animal Welfare,
Tubwell House, New Road, Crowbrough TN6 2QH, UK

Jonathan Gordon, Wildlife Conservation Research Unit, Department of Zoology,
South Parks Road, Oxford OX1 3PS, UK

INTRODUCTION Harbour porpoises are shy, undemonstrative creatures that are extremely difficult to spot at sea. Visual surveys can only be attempted in the calmest conditions (which are rare in northern Europe) and rigorous surveys usually require expensive dedicated platforms and substantial teams of observers. Harbour porpoise vocalisations consist of ultrasonic pulses centred in a narrow band at around 130 kHz. They can be readily detected in the field using a high frequency hydrophone and appropriate detection equipment. For these reasons, the International Fund for Animal Welfare has been developing equipment and techniques for assessing harbour porpoise populations acoustically.

Acoustic techniques for assessing cetacean populations often offer important advantages over visual methods, for example:

- . The acoustic range of vocalisations is typically more predictable than visual range.
- . Acoustic range is less affected by meteorological conditions than visual range.
- . Often (particularly when small research vessels are used) acoustic range is superior to visual range.
- . Acoustic surveys are less onerous than visual surveys so smaller survey teams can be used.
- . Acoustic surveys can be conducted 24 hours a day. Both day and night.
- . There is a greater potential for automation of data collection and detection, further reducing the size of survey teams and reducing the scope for inter-observer biases.
- . Generally, acoustic surveys are well suited to completion from small platforms of opportunity. This can greatly reduce the cost of surveys.

Field tests, carried out using towed high frequency hydrophones and amplitude modulation detection equipment during joint visual surveys in 1992 and 1993, showed that: (1) harbour porpoises can be detected acoustically at substantial ranges (possibly as great as 800-900m*); (2) they can be more reliably heard than seen, and (3) they were never seen and not heard. Further, the acoustic detectability of harbour porpoises seems to be unaffected by sea state.

Encouraged by these results it was decided to develop equipment to automatically discriminate harbour porpoise clicks and to log their occurrence to a portable computer. Such equipment should make acoustic surveys even easier to perform and eliminate errors due to inter-individual variation in operators' abilities to distinguish harbour porpoise vocalisations.

The first version of this computerised equipment has just been tested in the field and has performed very well. Construction of a series of Mark I production models is now underway.

OUTLINE DESCRIPTION OF EQUIPMENT Harbour porpoise vocalisations are distinctive, high frequency (c. 130 kHz), narrow band pulses. Other sources of noise at sea at these frequencies, such as dolphin clicks and depth sounder pulses, can be distinguished from harbour porpoises because they have a wider bandwidth and different frequency emphasis.

The equipment monitors the output from a towed hydrophone with click detectors sensitive to three different frequency bands, one of which is centred on 130 kHz. When a click is detected, the levels in these frequency bands are passed on to the computer through its RS232 port (Figure 1). A sound is only scored as a likely porpoise vocalisation if the energy is strongly dominant on the 130 kHz channel. Later analysis of relative frequency emphasis, trigger patterns, and repetition rates helps to further eliminate false triggers.

USE OF THE EQUIPMENT IN SURVEYS Several sets of equipment will be deployed on vessels involved in the SCANS survey. This will provide an opportunity to calibrate the equipment against rigorously collected visual data. Methods for using the acoustic cues which can be collected in this way to obtain relative (or possibly actual) density estimates are being developed by Dr Justin Cooke (Centre for Ecosystem Management Studies). The equipment is compact, inexpensive and largely autonomous. It can easily be deployed from any modest platform of opportunity and should thus allow substantial survey effort to be achieved at minimal cost.

The equipment, or modified versions of it, are also likely to be suitable for surveying other species of small cetaceans. Other phocoenids including the vaquita, and *Cephalorhynchus* spp., which make similar vocalisations are likely first candidates. With slight modifications, the equipment should be useful for assessing populations of other small cetaceans which are difficult to see, such as river dolphins.

OTHER APPLICATIONS We also foresee a use for this equipment in studying the process by which small cetaceans become entangled in fishing nets. For example, with very little modification, self-contained units in small waterproof housings could be deployed on bottom-set fishing nets. The equipment may also be useful in studies designed to monitor the effects of disturbance.

ACKNOWLEDGEMENTS This work is funded by the International Fund for Animal Welfare. Fieldwork for this project has been conducted in collaboration with Aberdeen University Lighthouse Field Station, the Dyfed Wildlife Trust, Dr Peter Evans and the experimental cruise of the SCANS survey.

* It is difficult to accurately measure the ranges at which porpoises can be detected in field conditions with this equipment. The value given is merely our best, but approximate, measure of maximum range. It was obtained by motoring towards groups of feeding porpoise in Shetland once they had been detected acoustically by an experienced operator, and measuring the distance travelled to reach them on the boat's log. Feeding porpoises were detectable at this range due to the extremely calm sea conditions prevailing at the time but independent visual detection also took place from a land-based observer conducting simultaneous watches from a cliff-top. The fact that click intensities rose appropriately as the group was approached and that consistent results were obtained on several occasions gives us some confidence in these results. They are also in line with theoretical calculations. These are maximum ranges of detection by an experienced operator in good field conditions. They are not presented as being mean detection ranges in all survey conditions.

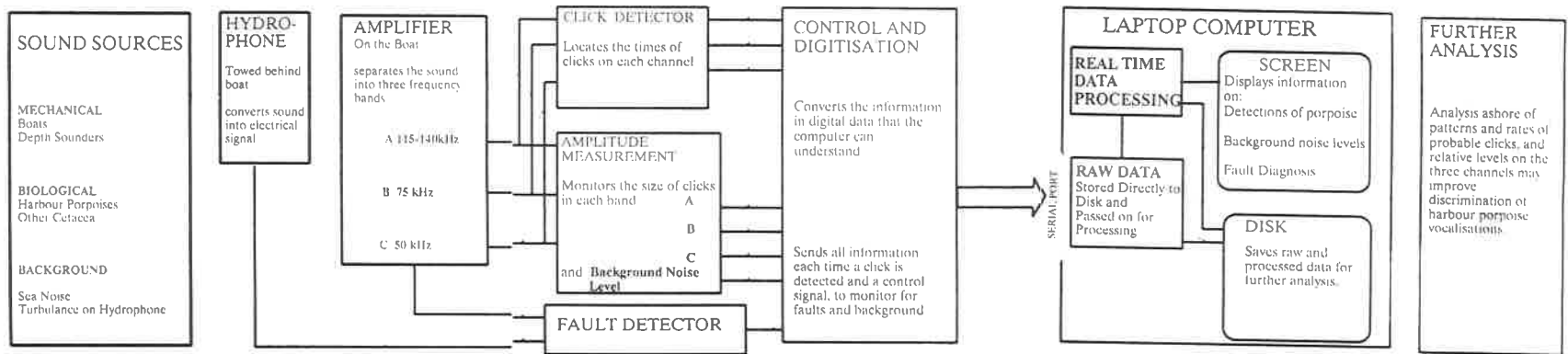

Fig. 1 Schematic diagram of Harbour Porpoise Acoustic Detection Equipment

A COMPARISON OF VISUAL AND ACOUSTIC TECHNIQUES FOR SURVEYING HARBOUR PORPOISES

P.G.H. Evans* and O. Chappell**

*Department of Zoology, University of Oxford,
South Parks Road, Oxford, OX1 3PS, UK

**International Fund for Animal Welfare, Tubwell House,
New Road, Crowborough, TN6 2QH, UK

INTRODUCTION Porpoises are notoriously difficult to survey at sea because they are small, and relatively inconspicuous above the surface. The type and height of survey platform, its speed, and observer ability may all affect sighting frequency and distance. Furthermore, with increasing sea state, the distance that porpoises are visually detectable decreases. Acoustic techniques have the potential advantage of being relatively independent of all these factors, but on the other hand, may be less capable of providing accurate estimates of group size. The purpose of this project was to compare the efficiency of acoustic monitoring of porpoises with visual surveys.

METHODS Harbour porpoises are highly vocal, and make very short, high frequency (130 kHz) narrow-band pulses of sound (Amundin, 1991; Sturtivant *et al.*, this volume; Chappell & Gordon, this volume). Using a towed broad-band hydrophone in conjunction with custom-built detectors, and two trained observers, five boat transects were conducted in the coastal waters of Southeast Shetland during August 1993, for a comparison of estimated group size, frequency and maximum distance of detection by five-minute period. The vessel used was a 10-metre fishing boat and the height of observation was 3.5 m above sea level. The intensity of acoustic signals was measured and scored on a scale of one (weakest) to five (strongest).

For four of the transects, a land-based observer was also used to overlook an area of known porpoise concentration (Mousa Sound) through which the boat travelled a number of times. This allowed an independent assessment of porpoise numbers present, and a separate estimate of the limits of their detectability. Observations were made in sea states varying between zero and four.

RESULTS Although porpoises were sometimes seen before they were heard, there was no five-minute period with visual but no acoustic registrations. In fact, in only 101 (59%) of 170 five-minute periods when acoustic monitoring detected porpoises, were they also seen. The efficiency of visual sightings depended upon sea state. Up to sea state two, in 66% (n = 122) of five-minute periods porpoises were seen as well as heard; above sea state two, this declined to 42% (n = 48); above sea state three, this had declined further to 39% (n = 23). Figure 1 shows the variation in visual sighting efficiency for different sea states from zero to four.

In an attempt to obtain an estimate of the range of detection by both visual observation and acoustic monitoring, the distance that porpoises were first observed was estimated. Visual detection distances were affected by sea state (Figure 2), the average distances declining steadily from 237 metres at sea state 0 to only 16 metres at sea state 3. Average distances of visual detection were also compared for five different strengths of acoustic signal. These also showed an overall decline with increasing strength. Sample sizes for strengths 1 & 2 were small and so have been combined, giving a mean distance of 253 metres (n = 11). This declined to 234 metres at acoustic strength 3 (n = 25), 157 metres at acoustic strength 4 (n = 44), and 99.5 metres at acoustic strength 5 (n = 111).

The effectiveness of visually registering porpoises for different sea states can also be examined by comparing the proportion of five-minute periods when porpoises were seen as well as heard at various strengths of acoustic signal for each sea state (Table 1). These indicate that at sea states zero and one, visual detection of porpoises is efficient when the strength of acoustic signal is 3 or above (from the above results, this implies an average distance of around 250 metres). At sea state two, the efficiency of visual detection is reduced, particularly for acoustic signal strengths below 4 (i.e. above around 150 metres). By sea state three, this had been reduced further, with virtually no porpoises visually detected below acoustic strength 5 (i.e. beyond about 100 metres). Although it was possible to reliably distinguish single animals, small (2-3) and large (>3) groups from one another by acoustic means (using click emission patterns), determination of group size more accurately than this proved more difficult. Further work will need to be carried out in this subject area before it can be used in a more quantitative manner than presented here.

Land-based watches from a headland provide a good opportunity to survey a broader area than is possible from a boat. The maximum distance at which porpoises can be seen from this site varies with sea state from 1.3 km at sea state 3 to more than 3.0 km at sea state 0. On six occasions during simultaneous watches, porpoises were seen from land but not registered from the boat. The average distance of those porpoises from the boat was 1.06 km. Although in two cases porpoises were seen from land but not heard from the boat at distances of 380 and 400 metres respectively, on both occasions, they were travelling away from the vessel and so it is likely that the acoustic signal would be low. It is worth noting that on a number of occasions, porpoises were observed to move away from the approaching vessel (see also Evans *et al.*, this volume).

As an independent measure of the distances at which porpoises were being detected acoustically, the porpoise-vessel distance of each sighting made from land was estimated and compared with its signal strength measured from the boat. Average distance of fourteen registrations was 401 metres (range 90-840 m). Sample sizes are too small for meaningful comparisons of distances with acoustic signal strength. The average distance of five registrations at strength 5 was 244 metres and of six registrations at strength 1 was 466 metres. However, within a strength class, there was wide variation: 90-520 metres for strength 5 and 230-840 metres for strength 1. It is worth noting that within a particular strength class, the lowest distance values were always of porpoises moving directly away from the boat.

DISCUSSION AND CONCLUSIONS The results presented show that this acoustic method is virtually always more effective at detecting porpoises than visual methods. The effective distance at which porpoises can be detected acoustically will vary with various factors, particularly the number of porpoises present and their behaviour. If they are actively echo-locating as they travel away from the boat, their acoustic signals will be lower than if they are directed at the vessel. It is difficult to accurately determine the distance at which a porpoise is first detected acoustically, given that porpoises can be underwater at the time of first detection and individuals may therefore be closer than registered visually. However, a comparison of average distances for various signal strengths may provide an approximate measure. The results presented above suggest that under some circumstances, acoustic detection may occur at distances of 600-900 metres. This obviously requires experimental verification, and is beyond the distances of acoustic detection derived theoretically, based upon sound source levels of captive animals (see Amundin, 1991). On the other hand, in the restrictive conditions of captivity, porpoises may reduce the sound intensity of their sonar, yielding under-estimates for the distances over which they can be heard. Whatever, the actual distance that is possible for detecting porpoises acoustically, it is clear that it is a more efficient method for registering the presence of this species. Besides the reduced effort required in monitoring by this means, it has the strong advantage of being independent of sea state. Indeed, a comparison for different sea states of the frequency of five-minute periods when porpoises were registered acoustically, showed a steady increase from 31% (sea state 0) to 79% (sea state 3). By contrast, the frequency of visual registrations remained more or less constant at around

30% with increasing sea state. Either porpoises were using these waters more as seas became rougher, or they were echo-locating more.

Land-based comparative watches showed that both visual and acoustic surveys missed some animals within 0.4-1.5 km of the boat, and that porpoises not infrequently responded negatively to the boat's approach. Acoustic monitoring is therefore not 100% efficient at distances of 400 metres or more. Nonetheless, the results presented here indicate that it is totally efficient within 150-250 metres (the precise distance has yet to be determined). At sea state 0, porpoises may be recorded visually at greater distances than they can be detected acoustically, but by sea state 2, acoustic detection appears to be more efficient than visual detection (although as yet, quantification of the numbers of individuals present may best be made visually). These conclusions apply to the particular vessel used for this study and its viewing height of 3-4 metres. It is quite possible that different results would be obtained if other viewing platforms were used.

ACKNOWLEDGEMENTS Grants in support of this project were kindly provided by the World Wide Fund for Nature UK (through funds donated by Bulgari Ltd), the Shetland Amenity Trust, and Scottish Natural Heritage. We also thank the International Fund for Animal Welfare for enabling Oliver Chappell to travel to Shetland. Racal Recorders kindly provided us with a Racal Storr 141 tape recorder. Assistance with fieldwork was provided by Quentin Carson, Paul Harvey, Bill Jordan, Rachael Limer, Ian Rees, and John Uttley. Finally, we thank Robbie Leask and Jimmie Birnie for skippering the "Queen of Hearts" during boat surveys, and Martin Heubeck (SOTEAG), and the staff of the SNH office in Lerwick for help at various stages of the project.

REFERENCE

Amundin, M. (1991). *Sound production in odontocetes with emphasis on the harbour porpoise (Phocoena phocoena)*. Doctoral dissertation, University of Stockholm.

Table 1 Comparison of proportion of five-minute periods when porpoises detected acoustically were also observed visually, for five different signal strengths vs sea state

Sea State	Acoustic Signal Strength									
	5		4		3		2		1	
	%	n	%	n	%	n	%	n	%	n
0	100%	8	86%	7	86%	7	33%	6	33%	9
1	95%	20	100%	7	67%	3	0%	4	0%	6
2	76%	25	78%	9	25%	12	37%	8	25%	8
3	58%	12	0%	1	0%	4	0%	1	33%	3

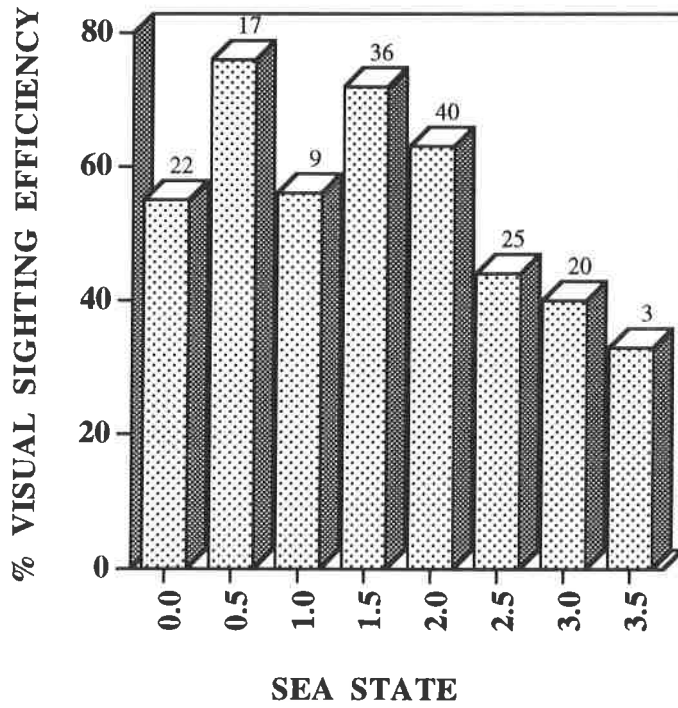

Fig. 1 Variation in Visual Sighting Efficiency (expressed as % of 5-min. periods when porpoises detected acoustically were also seen) for different sea states

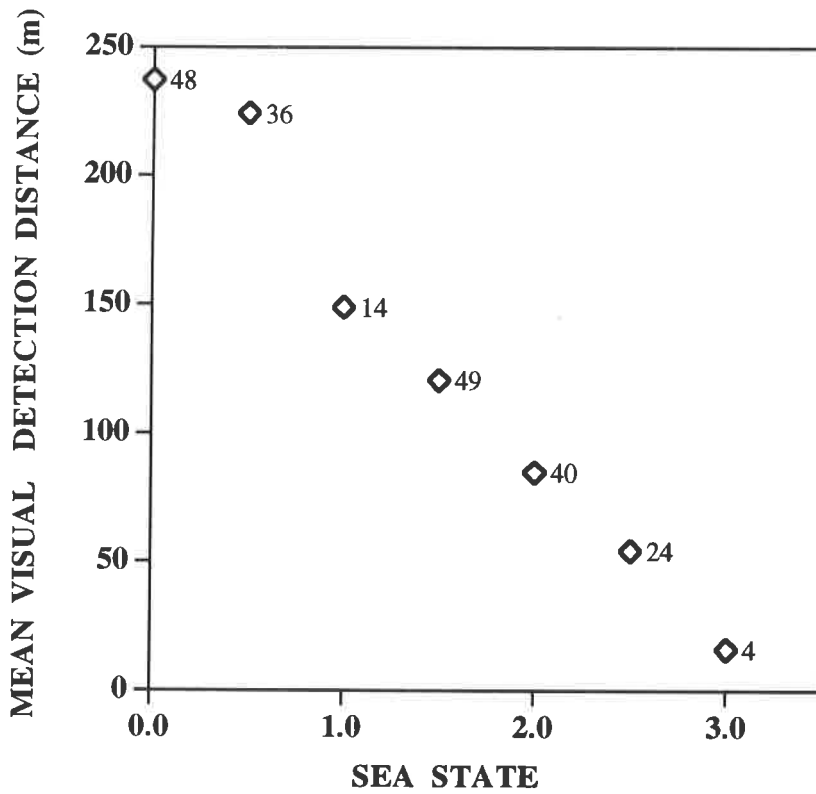

Fig. 2 Porpoise Visual Detection Distances (and sample sizes) for different sea states

A SIMPLE PHOTOGRAMMETRIC METHOD FOR MEASURING RANGES TO CETACEANS AT SEA

Jonathan Gordon

Wildlife Conservation Research Unit, Department of Zoology,
South Parks Road, Oxford, OX1 3PS, UK

INTRODUCTION It is often important to be able to measure the range to whales and dolphins at sea. In particular, range to objects of interest is crucial data required for estimating abundances using "distance" methods, such as line transect or point transect. These methods are usually recommended for surveys of cetaceans. Range is difficult data to acquire, however. Many studies have shown that estimates of range at sea made by unaided human observers are inaccurate, and, worse, are often biased. No range finders currently available are easy to use with cetaceans in field conditions.

An approach which is widely used for range estimation to floating objects is to measure the angle subtended between the object and the horizon. Provided that the observer's height is known accurately, this measurement can be used to calculate the range to the object of interest using the following equation:

Range (D) is given by:

$$D = (R+h) \cos \beta - \sqrt{(R+h)^2 \cos^2 \beta - (R+h)^2 + R^2}$$

Where:

β is the angle subtended between the object and the vertical

$$\beta = 90 - \partial - \forall$$

∂ is the angle of dip from the horizontal to the horizon

$$\partial \text{ (mins of arc)} = 0.98 \sqrt{\text{height (feet)}}$$

\forall is the angle subtended between the object and the horizon

D is the distance to the object

R is the radius of the earth

h is the height of the camera above sea level

Note: these calculations must be done in double precision.

Usually observers have used vernier callipers held at arm's length to measure angles, or they have interpolated ranges between markings on simple sightings sticks held at arm's length or between verniers in the eyepieces of binoculars. With fast moving objects which are only fleetingly visible, it is impossible to take these measurements accurately. There are also problems with the ways in which observers interpolate the values of ranges which fall between markings.

An alternative way of accurately and instantaneously measuring the angle between a floating object and the horizon is to take a photograph showing the object of interest and the horizon. The angle can then be simply calculated from the distance between the object and the horizon on the photographic image and the focal length of the lens used to take the

photograph. These measurements can also be taken from video and this is more appropriate for species which are particularly difficult to spot such as dolphins and harbour porpoises.

METHODS

Investigation of Likely Errors by Simulation

Waves and Swell The most likely cause of errors in range are variations in the height above mean sea level of both the platform and the object due to waves and swell. The effects of such errors acting independently on the platform and the object were investigated using a Monte-Carlo simulation.

Proportional standard deviation due to these effects was found to be 0.5 of the vertical movement as a proportion of camera height. Thus range errors depend on wave or swell height as a proportion of the observer's height. No significant bias was introduced by these movements, so accuracy will be improved by taking the mean of several photographs. It should also be noted that heavy objects, such as whales and boats, do not rise and fall as much as wave height.

Boat Movements Errors in height due to rocking are unlikely to result in any significant errors in height. However, consistent angles of heel, as might be encountered on sailing boats, should be measured and allowed for.

Refraction The angles subtended by distant objects will be small and it is possible that refraction (which varies slightly with atmospheric conditions) will become a cause of error. Formulae exist for calculating refraction in different atmospheric conditions. However, a more practical approach may be to check for this by regularly taking photographs of distant objects at known ranges (determined by radar or by log).

Field Techniques Photographs have usually been taken using standard 35mm cameras with 300 and 400mm lenses whose focal length has been measured. Ilford XP2 black and white film has proved particularly suitable. Polarising or coloured filters can be used to enhance the definition of the horizon. Photographs are taken from a point whose height above sea level is known. (It may be necessary to check this regularly as it is affected by factors such as the amount of fuel and water on the boat).

Suitable video images have also been obtained of animals which are difficult to photograph, such as harbour porpoises. If this approach is to be pursued, video cameras which have good freeze-frame facilities should be used. Images could be transferred to computer using a video card for analysis.

Note: In some situations whales will be photographed with a coastline in the background. This is not a problem provided that the range to the shore is known. (In such cases the boat's position and the bearing to the whale should be recorded for each photograph). Unless the land is very close, it is likely that one will still see the real horizon in front of the land. (At a height of 10m the range to the horizon is 6.5 nautical miles, at 15m it is 8.1 nautical miles.) At closer ranges, a simple adaptation of the formula can be used.

Analysis Techniques The relevant data, at least two points to define the horizon and a point to mark the waterline of the floating object, can be simply obtained by projecting photographs onto plain paper using a photographic enlarger and marking their positions using a sharp pencil. The degree of enlargement is determined by measuring the projected image of an object of known size. (Film sprocket holes which are 2mm long are useful for this). The perpendicular distance from the horizon to the object can then be determined using a ruler and set-square. If a large amount of data is to be processed, a digitising tablet (preferably one allowing back-projection) should be used.

Field Tests A series of photographs of an object at known ranges was taken to test the accuracy of the technique. Ranges were measured independently using a GPS navigator.

Range photographs were also taken in survey-type situations of sperm whales in the Azores, minke whales off Mull, Scotland, and fin whales in the Mediterranean.

RESULTS Ranges derived from the GPS and the photographic technique are compared in Fig 1. Of 53 comparisons made, the average percentage difference between the two methods was 2.9% (indicating little or no bias). The average absolute difference between photographic and GPS derived range estimates was 4.6% (indicating a useful degree of accuracy). It should be remembered that the GPS range estimation method is not without error so the differences between the two ranges are not all attributable to errors in the photographic method.

It has proved relatively easy to take photographs of sperm, fin and minke whales in field conditions. Sperm whales move slowly on the surface and blow regularly. This allows the average of several range estimates to be taken for each sighting in the survey. Useful photographs of sperm whales were taken at ranges out to 2,040 m while minke whales were photographed at ranges out to 980 m.

CONCLUSION Range is notoriously difficult to measure at sea but this simple technique which requires no specialist equipment will provide accurate and unbiased ranges and can be easily incorporated into surveys.

ACKNOWLEDGEMENTS

Photographs were taken from the International Fund for Animal Welfare's research vessel *Song of the Whale* and from Sea Life Survey's vessel *Alpha Beta*. Fieldwork would have been impossible without the hard work and co-operation of the crews of both vessels. Many of the minke whale photographs were taken by Sebastian Troeng. Lisa Steiner assisted with analysis, which was supported by International Fund for Animal Welfare.

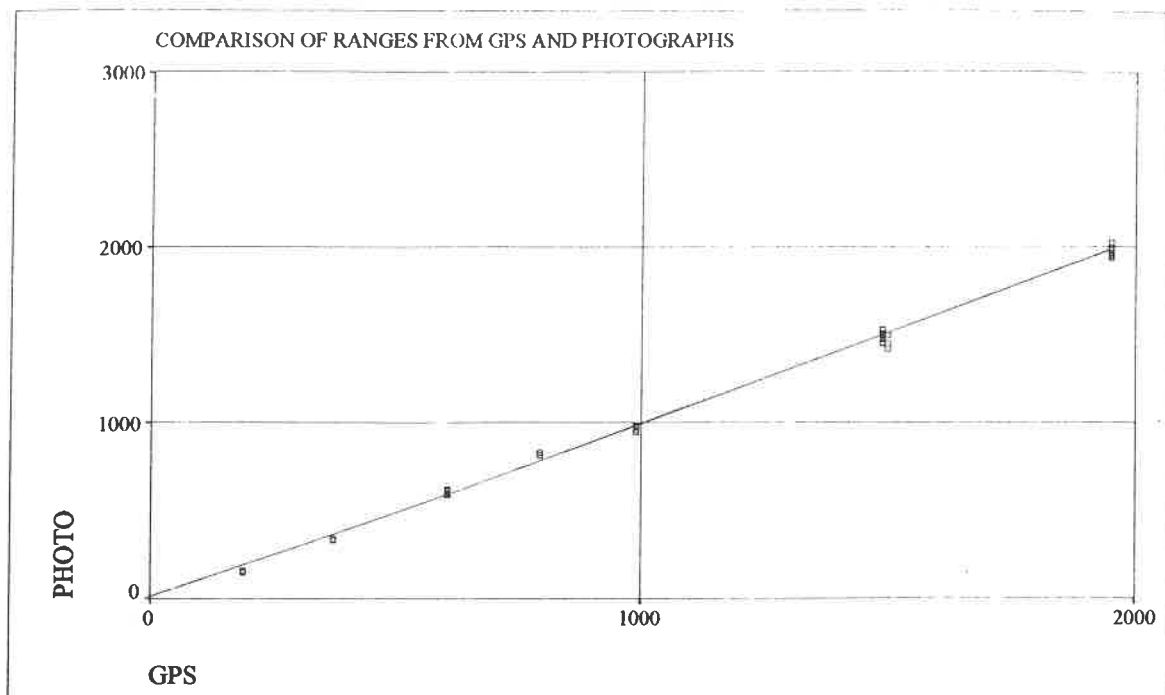

FIG. 1 Plot of ranges to floating object measured using a GPS navigator and by the Photographic method.

MEGANYCTIPHANES NORVEGICA AND FIN WHALES IN THE LIGURIAN SEA: NEW SEASONAL PATTERNS

Lidia Orsi Relini, Giulio Relini, Chantal Cima,
Giovanni Palandri, Marco Relini and Giovanni Torchia

Università degli Studi di Genova, Istituto di Zoologia,
Laboratori di Biologia Marina ed Ecologia Animale,
Via Balbi, 5, 16126 Genova, Italy

INTRODUCTION This study was carried out in an area of the NW Mediterranean where a cetacean sanctuary based on international agreements is envisaged. So far, the Italian government is alone in having placed actual restrictions on Italian fishing boats and has specifically prohibited the use of pelagic drift-nets in the Central-Western Ligurian Sea, an area which is limited by the coastline from Cap d'Antibes to Punta del Mesco and by the lines joining these two points to Cape Corso (Ministero Marina Mercantile DM 18/7/90; DM 22/5/91; DM 19/6/91; DM 12/8/92) (Orsi Relini *et al.*, 1992). Our research attempts to describe this environment from the physico-chemical and biological points of view with regard to the distribution and density of those organisms that can maintain a food supply for cetaceans.

The most numerous cetaceans in the area, striped dolphin (*Stenella coeruleoalba*), fin whale (*Balaenoptera physalus*), long-finned pilot whale (*Globicephala melas*) and Risso's dolphin (*Grampus griseus*) frequent the waters of the open sea, that is to say, a marine area of oceanic characteristics bounded by a permanent geostrophic front known as the Liguro-Provençal front (Bethoux *et al.*, 1988). An important characteristic of this area is that the processes of primary production which occur on the surface seem mainly to feed the mesopelagic rather than the epipelagic community (Boucher *et al.*, 1987; Jacques 1994; Orsi Relini *et al.*, 1994). The mesopelagic euphausiid shrimp *Meganyctiphanes norvegica* is a key species in the offshore food chains. It provides food directly for the fin whale (Orsi Relini and Giordano, 1992) and also plays a part in the diet of toothed whales in the sense that it is the food of cephalopods and fish upon which these marine mammals prey. The distribution of this species is therefore one of the main targets of our research.

METHODS In the period from 1991 to 1993, during six cruises on the R/V Urania and the R/V Minerva, we made observations in the offshore waters of the Ligurian Sea in an attempt to record simultaneously its hydrological characteristics and the presence of both *M. norvegica* and cetaceans. Three transects were established: (1) Genoa-Calvi; (2) Monaco-Calvi; (3) Marseilles-Gulf of Porto, and along these, hydrological and IKMT sampling stations were placed (Fig. 1).

The standard haul for macroplankton consisted of an oblique upward tow of a 15 feet open IKMT (2x2 mm mesh) from 750 m to the surface. The collected macroplankton was sorted into eight components (fish, cephalopods, crustacean decapods, *M. norvegica*, other euphausiids, other crustaceans, pteropods and jelly macroplankton). Bathysondes were used to provide continuous measurements of salinity, temperature and dissolved oxygen so as to obtain vertical profiles between 0 and 1000 metres.

Observer teams were organised during all the cruises, and every sighting was recorded together with its geographical position. While relatively unproblematic in summer, these operations became difficult in spring and autumn because of the small amount of time when the ship was available for use and due to adverse sea & weather conditions (Table 1).

RESULTS We report here on a study in progress, which has the aim of describing the seasonal variations in the distribution of *M. norvegica* throughout the year. Until now, the available patterns refer to summer, autumn and spring.

Summer In August 1991, the complete sampling grid was covered and a large patch of *M. norvegica* was found in the northern sector of transect B and along transect D (Fig. 2). During the cruise, a total of 52 whales was seen and a relationship between whale sighting/per mile and collected euphausiids could be established (Relini *et al.*, 1992). At the centre of the patch of *M. norvegica*, not only fin whales, but also striped dolphins, pilot whales, and tuna were recorded, so that the area can be considered a hot spot of pelagic life.

In summer 1992, only six stations could be made; however, a good quantity of *M. norvegica* was found along transect D, in a position north-east of the patch found the previous summer. During the short period of navigation, only three whales were seen, all of them around station B7.

In August 1993, nine stations were sampled along the A, B and D transects. The richest haul was recorded at B5; however, indirect observations suggest that a peak in euphausiid abundance was located at B6. In fact before sunset, tuna, striped dolphins and fin whales were seen around station B6 as had occurred the previous year at B3. The ship stopped at station B6 during the night, when an attempt was made to fish tuna. One caught specimen (Fl 88 cm; 10.6 kg) had its stomach full of *M. norvegica* (at least 1,088 specimens). Unfortunately, the next morning the rough sea prevented any sampling work.

It is interesting to note that all the above mentioned summer peaks were located on the Liguro-Provençal Front (see Fig. 1); in particular, the study of the hydrological characteristics at station B3 in summer 1991 showed that the surface water mass presented a minimum depth where the intermediate nutrient-rich waters could reach levels suitable for photosynthesis. A productive patch in terms of phytoplankton probably supported copepods and other microzooplankton (Boucher *et al.*, 1987), which in turn attracted *M. norvegica*.

Autumn Data for this season are scarce (Fig.3). However, in October 1992, *M. norvegica* was collected at station A7 in quantities similar to the 1991 summer peaks, and in December 1993 at station A3 at about 39% of this value.

Spring The transects A and B were sampled in March - April 1993. The highest value of *M. norvegica* was registered at B6 (Fig. 4), and around the station a total of ten fin whales was seen. Given that the sightings occurred when the sea was rough, the number of animals was possibly underestimated. The main result of this cruise is that *M. norvegica* proved to be abundant from the end of winter (the overall pattern is 50% of the summer values registered at the same stations) and also that the number of whales on the route covered was 38% of that registered in August 1991.

DISCUSSION In the offshore waters of the Ligurian Sea, hot spots of pelagic life may be found, where concentrations of tuna and of fin whales are the most outstanding features. Such phenomena have been repeatedly mentioned (Allain 1964, Della Croce 1969, Viale 1991).

During the present oceanographic cruises, three instances of this kind were found, two during summer and one in spring. In two cases, we established, by means of the IKMT sampling, that a concentration of *M. norvegica* (i.e. a patch) was at the basis of the concentration of large nekton. In a third case the net could not be operated, but the role of *M. norvegica* was indicated by the stomach content of the tuna.

Significant quantities of *M. norvegica* were found in all the seasons covered by the sampling, i.e. from spring to autumn. For the winter, when signs of reproduction were registered in *M. norvegica* (Casanova, 1970), the stranding of swarms provides an indirect indication of abundance.

So far as spatial distribution is concerned, it is interesting to note that the highest quantities of *M. norvegica* were sampled along the Liguro-Provençal front, in different positions according to the year and the season. The summer peaks for 1991 and 1992 were recorded on the northern edge of the front while from autumn 1992 to summer 1993, peaks of abundance were found on the southern edge (Corsica side).

It is possible that hydrological characteristics such as current gyres have a direct or indirect influence on the distribution of patches, for instance by means of accumulation of microplankton. The present data are still too meagre to allow any conclusions to be drawn; however, the variable positions of the spots suggest a mosaic turnover of resources of great biological significance.

REFERENCES

- Allain, C. 1964. Les poissons et les courants. Rev. Trav. Inst. Pêches marit., 28 (4): 401-426.
- Bethoux, J.P., Prieur, L., and Bong, J.H. 1988. Le courant ligure au large de Nice. Oceanol. Acta, 9:59-67
- Boucher, J., Ibanez, F., and Prieur, L. 1987. Daily and seasonal variation in the spatial distribution of zooplankton population in relation to the physical structure in the Ligurian Sea Front. J. Mar. Res., 45: 133-173
- Casanova - Soulier, B. 1970. Les rassemblements d' Euphausiacés en Méditerranée. Rapp. Comm. int. Mer Médit., 20, 3: 435-437
- Della Croce, N. 1969. Nota su un avvistamento di Tonni nel Mar Ligure. C.N.R. Comm. it. Oceanogr. (Ser. B), 30: 1-11.
- Jacques, G. 1994. Nouvelles vues sur le système pélagique de Mer Ligure. Biol. Mar. Médit., 1: 65-82
- Orsi Relini, L., Garibaldi, F., Palandri, G., and Cima, C. 1994. La comunità mesopelagica e i predatori "di superficie". Biol. Mar. Médit., 1: 105-112
- Orsi Relini, L., Relini, G., Cima, C., Fiorentino, F., Palandri, G., Relini, M., and Torchia, G. 1992. Una zona di tutela biologica ed un parco pelagico per i cetacei del Mar Ligure. Boll. Mus. Ist. Biol. Univ. Genova, 56-57: 247-282
- Orsi Relini, L., and Giordano, A. 1992. Summer feeding of the fin whale *Balaenoptera physalus* in the Liguro-Provençal basin. Pp. 136-139. In *European Research on Cetaceans - 6* (Ed. P.G.H. Evans). Proc. 6th Ann. Conf. ECS, 20-22 February 1992, San Remo, Italy. European Cetacean Society, Cambridge, UK.
- Relini, G., Orsi Relini, L., Cima, C., Fasciana, C., Fiorentino, F., Palandri, G., Relini, M., Tartaglia, M.P., Torchia, G., and Zaniboni, A. 1992. Macroplankton, *Meganyctiphanes norvegica* and fin whales, *Balaenoptera physalus* along some transects in the Ligurian Sea. Pp. 134-137. In *European Research on Cetaceans - 6* (Ed. P.G.H. Evans). Proc. 6th Ann. Conf. ECS, 20-22 February 1992, San Remo, Italy. European Cetacean Society, Cambridge, UK.
- Viale, D. 1991. Une méthode synoptique de recherche des zones productives en mer: détection simultanée des cétacées, des fronts thermiques et des biomasses sous-jacentes. Ann. Inst. océanogr., Paris, 67(1): 49-62.

Table 1. Cruises 1991 - 1993 of the R/V Urania and Minerva for the sampling of *M. norvegica*

	spring	summer	autumn
ship days	9	24	17
CTD profiles	13	47	16
IKMT hauls	12	35	7

Fig. 1 Sampling grid. The dotted area indicates the position of the Liguro Provençal front. **Fig.2-3-4.** Volumes of *M. norvegica* recorded in standard hauls during spring, summer and autumn.

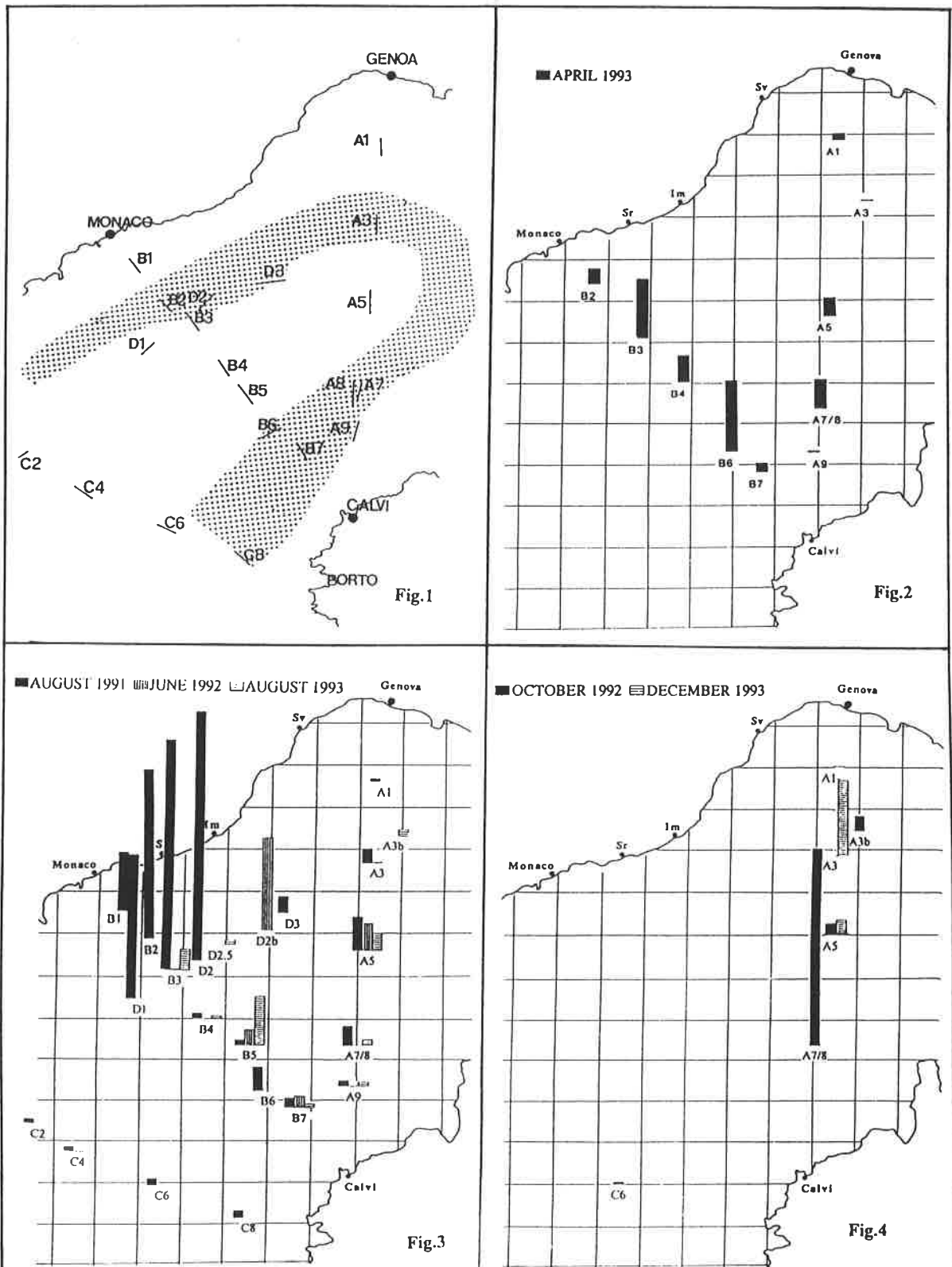

RELATIONSHIPS BETWEEN DOLPHINS, TYPE OF PREY AGGREGATION, AND THEIR GEOGRAPHICAL DISTRIBUTION

Massimo Azzali*, Lino Casini** and Claudia Virno Lamberti*

*C.N.R.-I.R.Pe.M., Molo Mandracchio, 60100 Ancona, Italy

**Fondazione Cetacea, Viale Milano 63, I-47036 Riccione, Italy

INTRODUCTION The consumption of small pelagic fish by dolphins in some areas of the Mediterranean Sea is large, perhaps of the same order of magnitude as the commercial catch. However, very little is known about the relationships between the geographical distribution of dolphins and their prey and the mechanism of predator interactions between dolphins and the fishing fleet. In an attempt to address this problem, the acoustic group of C.N.R. in Ancona, together with researchers of the Fondazione Cetacea in Riccione, have carried out a series of cruises since 1988 to collect simultaneous data on cetaceans and their prey. The sampled areas were the Adriatic Sea (1988-92), Tyrrhenian Sea (1988, 1991) and Sicily Channel (1988).

In this paper, the geographical distribution of encountered cetaceans and their prey, and the relationships between prey aggregations and dolphin species in all the sampled areas, are presented. This is followed by an analysis of the results obtained in the northern and central Adriatic Sea. We conclude by discussing some implications of the results for interaction between dolphins and the fishery.

MATERIALS AND METHODS The acoustic survey uses a line sampling technique, that takes the form of zig-zag transects, uninterrupted in space and in time (Azzali, 1980). The surveys were carried out in the same seasons for each area over several years (1988-1992). During the acoustic surveys, the following data were collected:

(1) Data on prey from hydroacoustic apparatus: (a) absolute estimates of density ($t/mile^2$) and biomass (t) of the pelagic fish populations as a whole and, within it, of some population such as anchovies (*Engraulis encrasicolus*), sardines (*Sardina pilchardus*), sprats (*Sprattus sprattus*) and other species (Azzali, 1981); (b) forms of aggregation (dispersed, schooled, and aggregations in layers) of the pelagic populations and their variability with time of day: dawn, daylight, sunset and night (Azzali *et al.*, 1985); (c) geographical and bottom depth distributions of all the above data (Azzali, 1988).

(2) Data on prey from pelagic trawls. During acoustic surveys, at intervals of 4-6 hours, a net was used to sample aggregations and to determine their structure (species and length of fish).

(3) Data on cetaceans (predators) from sightings. The presence of cetaceans was visually assessed along the transects by two experienced observers from a platform of the R/V S. Lo Bianco with 360° viewing. For each sighting, the following data were recorded: a) group size and composition; b) behaviour classified into two categories: hunting (which was related to the forms of aggregation), other activities (travelling, socialising); c) geographical position of the vessel (Latitude, Longitude, bottom depth, distance from the nearest coast, and from cetaceans); and d) date and hour. In the Adriatic Sea, the sightings from the research vessel were integrated with the ones collected from four liners of the "Adriatica" shipping company.

(4) Data on commercial catches and operational areas of the fishing fleet were obtained by official statistics (ISTAT) and from available literature.

RESULTS The total number of sightings per species and per sampled area are presented in Table 1. Ninety per cent of sightings consists of bottlenose dolphins (*Tursiops truncatus*) (53%) and striped dolphins (*Stenella coeruleoalba*) (37%).

Figure 1 shows the distribution of the sightings of these two species, which seem to have different patches. In the Ligurian Sea, Tyrrhenian Sea and in Sicily Channel, striped dolphins predominate. In the northern and central Adriatic Seas, virtually only bottlenose dolphins are present. In the southern Adriatic Sea and northern Ionian Sea, both species are found (bottlenose dolphins predominate in the western area and striped dolphins in the eastern area). Data on the average bottom depth of the sighting locations (Table 2) confirm the hypothesis that there are at least two patches in the habitat. The size of the groups varies considerably from one species to the other (Table 3).

The prey biomass in the areas covered acoustically (30,000 mile²) was assessed at around 1,130,000 t (average density: 43 t/mile²). However, its geographical distribution is very different in each area. About 67% of biomass is concentrated in the northern and central Adriatic Sea and only 5% in the southern Adriatic Sea. In the Sicily Channel, there is 15% of the total biomass, and in the Tyrrhenian Sea the remaining 18% (Azzali, 1988). In each area, the prey has its own characteristics of distribution and aggregation that influences the behaviour of fishermen and dolphins. In general, most of the dispersed or scattered forms of aggregation were found in the deep waters, and most of the schools and aggregations in layers occurred over the shelf (Azzali and Bombace, 1983).

The annual commercial catches in the sampled areas are estimated at around 300,000 t, that is 23% of the assessed biomass. About 60% of the catches came from the northern and central Adriatic Seas, where the majority of the Italian trawl fishing activity occurs. Here, the fishing effort is concentrated within the isobath of 50 m. The remaining 40% of the catches are obtained from the other areas, where the fishing fleet operates up to 200 m (ISTAT). Sightings of foraging dolphins and aggregations of their prey are reported in Table 4. The northern and central Adriatic Seas are characterised by a high variability in space and time of the resources common to fishermen and dolphins (Della Croce, 1982). Table 4 shows that 64% of schooled distributions and 68% of distributions in layers are within the 40 m isobath, where most of the fishing effort is concentrated, while 83% of bottlenose dolphins were encountered beyond this isobath. From these data, a habitat segregation between *Tursiops* and fishermen may be suggested. The data show that schooled distributions predominate during the full sunlight hours. It suggests that in this period of the day there is an overlap of activities between foraging bottlenose dolphins and the trawl fishing that operates in day time.

CONCLUSIONS The following conclusions were reached:

(1) *Coexistence of populations of bottlenose dolphins and striped dolphins* Striped dolphins and bottlenose dolphins prey upon pelagic resources (Leatherwood and Platter, 1975) similar in species but different in aggregation forms and separated by habitat. There is no interaction between the two species.

(2) *Interaction between striped dolphins and the trawl fishery* Striped dolphins hunt in deep water (Norris and Dohl, 1980) and upon scattered distributions, and so there would be a weak interaction with trawl fishing activity.

(3) *Interaction between bottlenose dolphins and the trawl fishery in the northern and central Adriatic Seas* In this semi-closed area, the population of bottlenose dolphins and trawl fishing fleet prey upon similar species and forms of aggregation (Leatherwood and Platter, 1975), probably in the same period of the day (Shane, 1977). A co-existence occurs through limited habitat segregation, possibly due to the spatial heterogeneity of the resources in this area.

REFERENCES

- Azzali, M. 1981. Comparazione circa la distribuzione e la stima di biomassa di sardine effettuata nel 1976 e 1977 con metodi elettroacustici in Alto e Medio Adriatico. *Quad. Lab. Tecn. Pesca*, 3(1): 33-48.
- Azzali, M. 1988. Una nota preliminare sulle risorse pelagiche nei mari italiani stimate con tecniche acustiche. *Atti Seminari per la Pesca e l'Acquacoltura*, 1: 98-171.
- Azzali, M. and Bombace, G. 1983. Valutazione e valorizzazione delle risorse pelagiche. *Nova Thalassia*, 6: 343-350.
- Azzali, M., Cosimi, G. and Luna, M. 1980. Valutazione elettroacustica degli stocks di Sardine (*Sardina pilchardus*) nell' Alto e Medio Adriatico. *Quad. Lab. Tecn. Pesca*, 2(5): 1-99.
- Azzali, M., Buracchi, G., Conti, S., Gambetti, S. and Luna, M. 1985. Relationships between the forms of pelagic fish distribution and nictemeral periods. A tentative model of behaviour. *Oebalia*, 11(2): 471-488.
- Della Croce, N. 1982. Biologia e pesca del pesce azzurro. Pp. 103-112. In *Il Mare e la Pesca*:
- Leatherwood, S. and Platter, M.W. 1975. A preliminary assessment of summer stocks of bottle-nosed dolphins, *Tursiops truncatus* in coastal water of Alabama, Mississippi and eastern Louisiana. *J. Wildl Manage.*
- Norris, K.S. and Dohl, T.P. 1980. The structure and functions of cetacean schools. Pp. 211-261. In *Cetacean behaviour: mechanism and functions* (Ed. L. M. Herman). Wiley, New York.
- Shane, S.H. 1977. *The population biology of the Atlantic bottle-nosed dolphin, Tursiops truncatus, in the Aransas Pass Area of Texas*. M.S. Thesis, Texas A & M University, College Station, Texas. 239 pp.

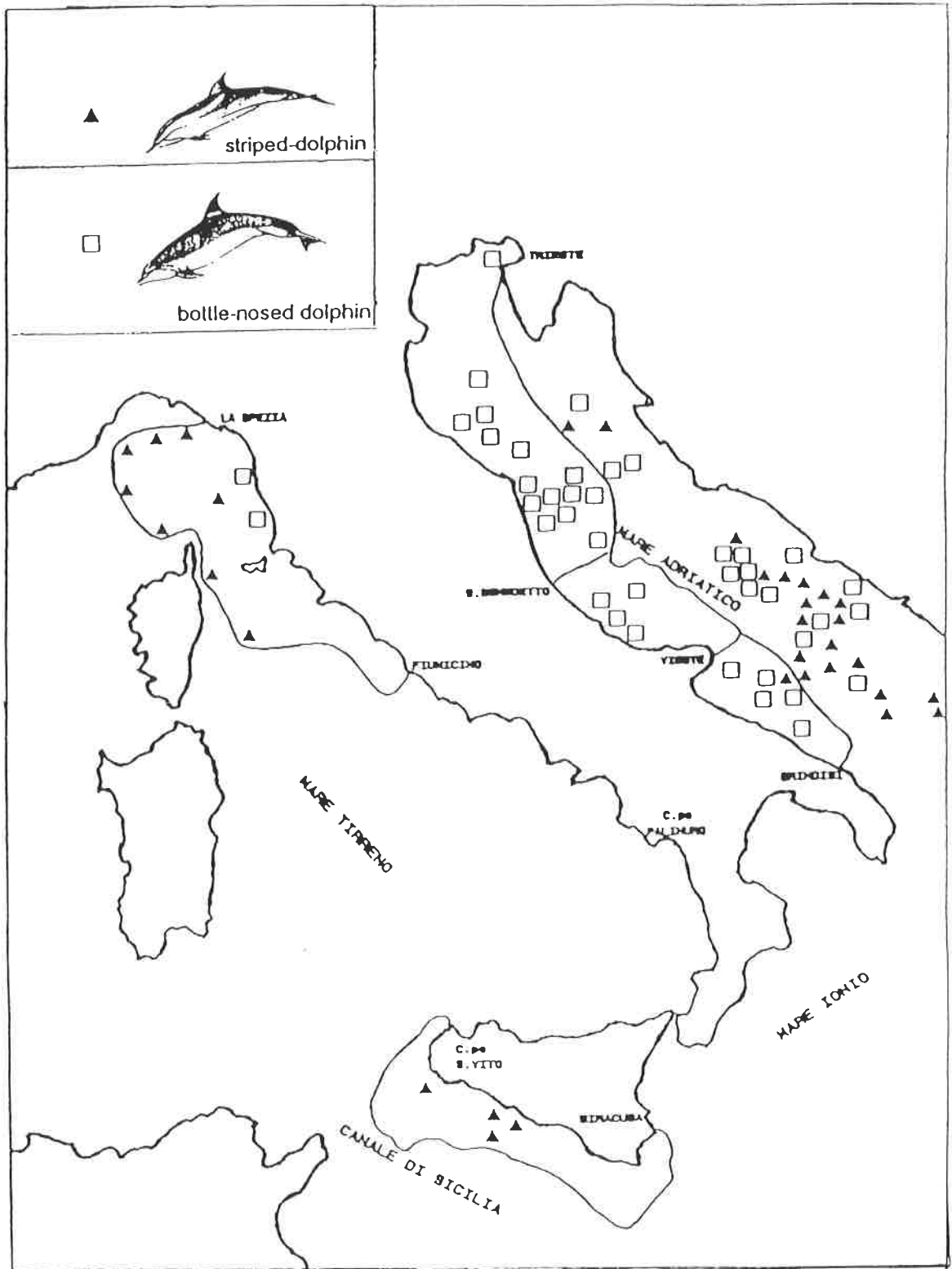

Fig. 1 Location of sightings of bottlenose dolphins (□) and of striped dolphins (▲)

Table 1 Total sightings for each cetacean species in the different sampled areas
 NA = Northern Adriatic Sea, CA = Central Adriatic Sea, SA = Southern Adriatic Sea
 NI = Northern Ionian Sea, SC = Sicily Channel, CT = Central Tyrrhenian Sea, L = Ligurian Sea

Species/Seas	NA	CA	SA	NI	SC	CT	L	Tot. Sight.
Bottle-nosed dolphin	6	31	7	2	1	2		49
Striped dolphin	3	12	5	3	3	3	5	34
Common dolphin	1	4						5
Risso's dolphin		1		1				2
Fin whale							1	1
Sperm whale		2						2

Table 2 Mean depth (m) of sighting locations of cetacean species in the sampled areas
 N = number of samples, X = mean value, S.D. = standard deviation, *t-test=3.37, p=0.0013

Species	Depth			
	N	Range	X	S.D.
Bottle-nosed dolphin	45	15-2500	256.6*	459.3
Striped dolphin	30	18-2600	705.23*	624.4
Common dolphin	5	55-1159	619.2	468.4
Risso's dolphin	2	400-600		
Fin whale	1	2000		
Sperm whale	2	416		

Table 3 Group size statistic for the encountered species in the sampled areas
 *t-test=3.25, p=0.003

Species	N	range	X	S.D.
Bottle-nosed dolphin	43	1-10	4.21*	3.17
Striped dolphin	34	2-90	14.68*	18.59
Common dolphin	5	4-20	8.40	6.66
Risso's dolphin	2	2-7		
Fin whale	1	2		
Sperm whale	2	1		

Table 4 Relationship between dolphin species and aggregation forms of prey in the in the sampled areas

Species/prey aggregation	disperse	layer	school	Chi sq.	d.f.	p
Bottle-nosed dolphin		2	21	35.04	1	0.001
Striped Dolphin	7	2	2	4.54	2	n.s.

FORAGING ACTIVITY PATTERN OF BOTTLENOSE DOLPHINS AROUND ILE DE SEIN, FRANCE, AND ITS RELATIONSHIPS WITH ENVIRONMENTAL PARAMETERS.

C. Liret*, P. Allali*, P. Creton*, C. Guinet** and V. Ridoux*

* OCEANOPOLIS, Département Mammifères Marins,
BP411, Brest 29275, France

** Current address: CEBC/CNRS, Villiers en Bois,
Beauvoir s/s Niort 79360, France

INTRODUCTION Bottlenose dolphins (*Tursiops truncatus*) are resident around *île de Sein* all the year round. The size of the group has been estimated from recent studies to be 13-14 individuals of which nearly 100% are photo-identified. Similarly the home range has been estimated at less than 3 km². Moreover, the core of this range lies very close to the inhabited island. Consequently it is easier to study the group living there than in most other more extended sites. These favourable field conditions encouraged us to start a study of feeding ecology which focuses on the relationships between environmental parameters, prey availability and dolphin activity patterns.

MATERIALS AND METHODS As a first approach, the dolphins' habitat has been mapped onto a 200 m cell-sized grid of the area. Data were collected by tracking the dolphins from a rubber boat, the dolphins' location and activity being recorded every five minutes. Field sessions took place in September 1992, April, May, August and September 1993.

The second approach is to estimate variations in prey flux in relation to the tidal cycle. Underwater video recordings were made concurrently with dolphin activity and current speed monitoring. The video camera was set at a right angle relative to the current and the records were for ten minutes every 30 minutes during the entire tidal cycle. The rather poor water clarity and the coarseness of the video pictures relative to the size of the drifting items observed precluded totally safe discrimination between fishes and other drifting items like seaweed debris and macroplankton. Consequently, all items were counted on the screen and several validation trials were performed by simultaneous counting of these items on the screen and of fishes underwater by a diver.

RESULTS The main feature evidenced by this approach was the existence of a limited number of spots where the dolphins concentrate most of their time (Fig. 1). Two of these spots are mostly foraging sites whereas the third one is both a foraging site and a place where the dolphins interact with boats. This latter site is located at the entrance of the harbour and was mostly used in August when the tourist season and boat traffic were at their highest. The two former sites were used during every study period.

We have then concentrated our efforts on only one of the foraging sites in an attempt to find a consistent temporal pattern of site utilization by the dolphins. It clearly appeared that the dolphins were present in this site mainly during rising tide and that their predominant activity was foraging in the tidal current (Fig. 2). The proportion of time spent foraging in this site increased with current speed (Fig. 3) which suggested that food availability also increased with current speed.

The next step of the study was to elucidate the biological link relating dolphin activity rhythm to tidal rhythm. The explanatory hypothesis we have tested is that the narrow pass where the dolphins consistently forage could act as a funnel in which drifting pelagic fishes would be concentrated by the tidal current. Additionally, this hypothesis would explain

why the group of dolphins can concentrate their predation on such a small home range, although local annual productivity is very unlikely to provide sufficient food.

The video recordings have shown that the flux of drifting items was not significantly related to tides (Fig. 4). Furthermore, a 1 cm mesh-size experimental pelagic trawl was deployed in the pass in order to sample the drifting pelagic fauna of the current vein; again no pelagic fauna of any significance in terms of food resource for the dolphins was noted by this method even though the fishing position of the trawl was monitored by video.

CONCLUSIONS In conclusion, it appears that the presence of the dolphins in the pass is strongly linked to the tidal rhythm since they forage there mostly during a rising tide. Secondly, no flux of drifting items was shown to be related to current speed. Thirdly, the nature of the items pelagically drifting is unknown but they can by no means be considered as direct prey for the dolphins since most of them are probably smaller than the 1 cm mesh size of the trawl. Such conclusions are not consistent with the hypothesis of pelagic fishes drifting in the current vein and being concentrated in the passes as the primary source of food for the dolphins.

This conclusion suggests an alternative explanatory hypothesis with an intermediate level of predation. The dolphins could preferentially forage in these passes at rising tide because local fishes would become more available to them as a result of their own enhanced feeding activity. However, the question of how such a small home range can support predation by thirteen species of large mammalian predators remains open.

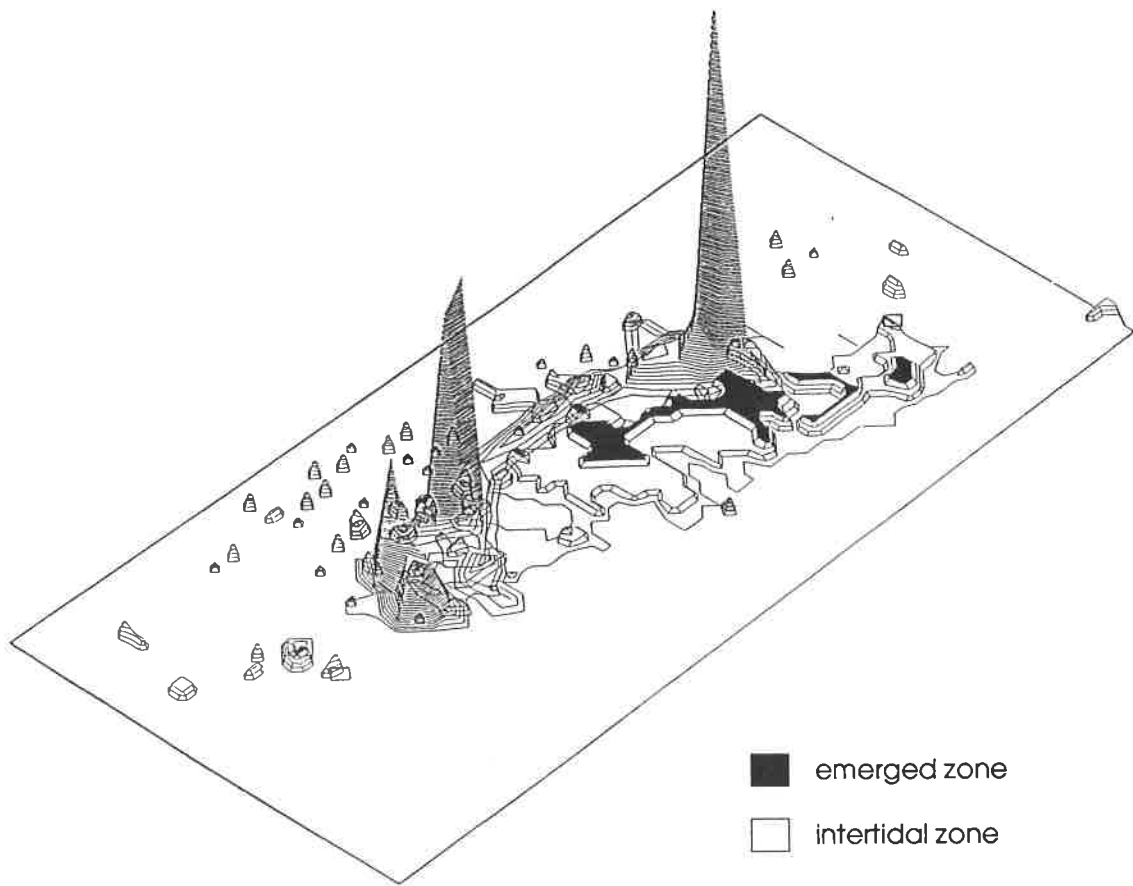

Fig. 1 - Follow-up for all seasons and activities (n=901)

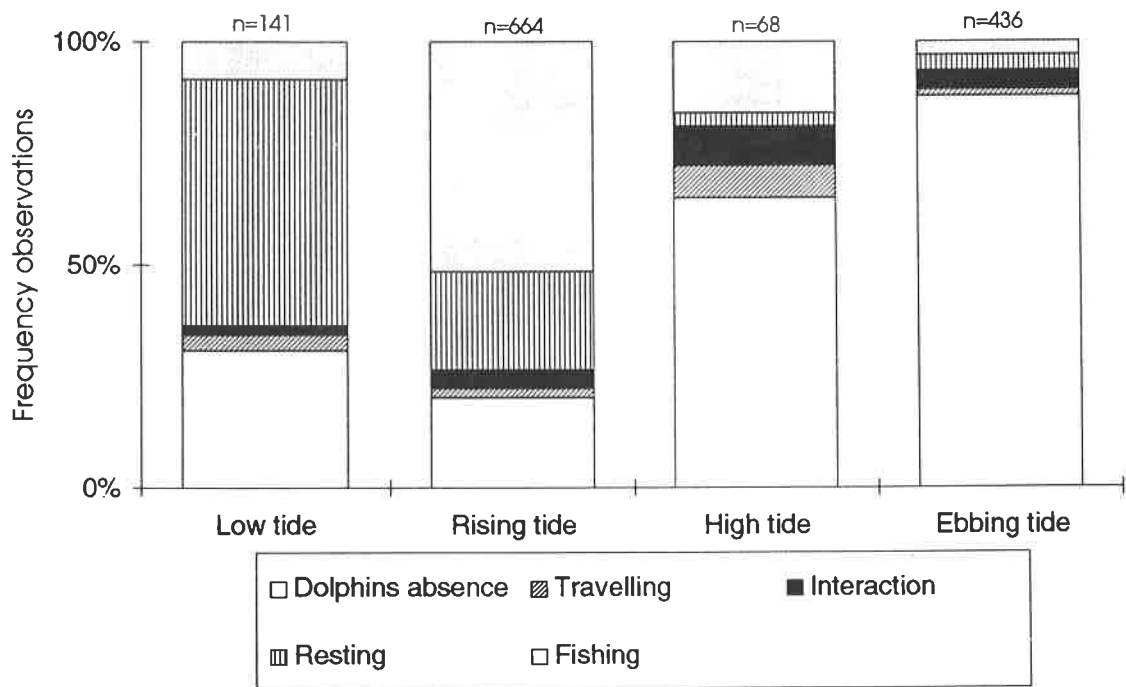

Fig. 2 - Dolphins activities versus tide cycle in "passe d'Ar Bouffe"

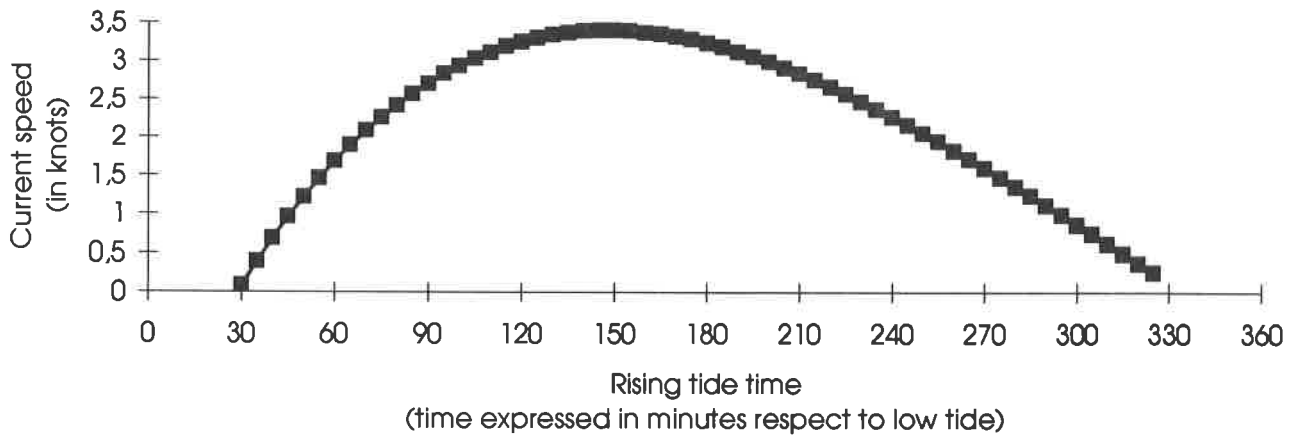
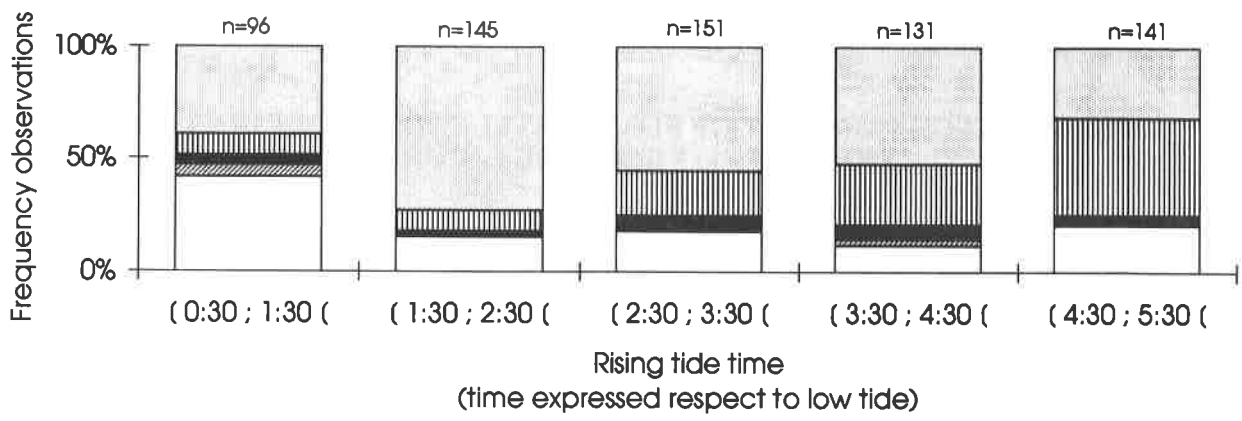

Fig. 3 - Changes in dolphins activities and current speed (coefficients 60-80) during rising tide in "passe d'Ar Bouffe"

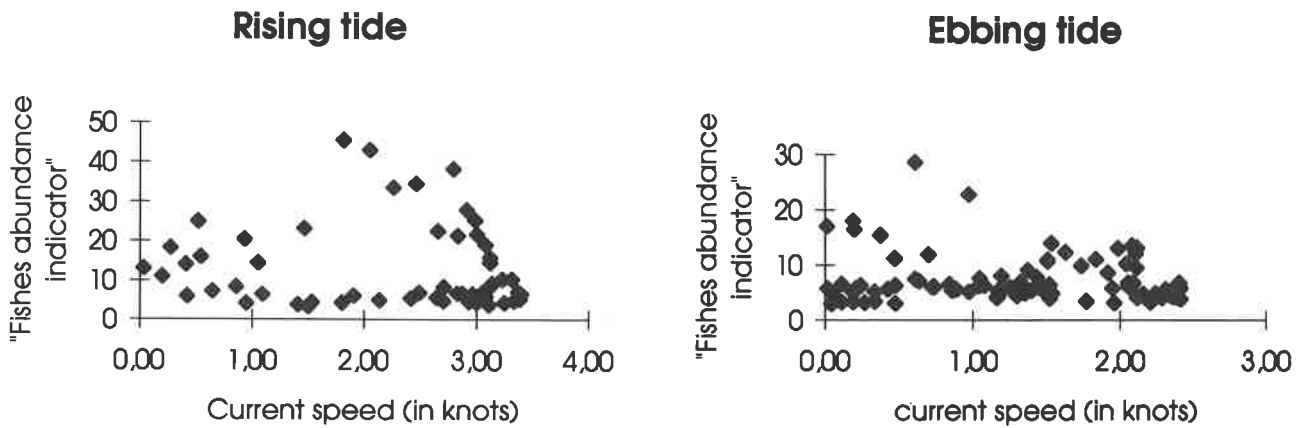

Fig. 4 - Variation in "fishes abundance indicator" versus current speed

THE STOMACH CONTENT OF SOME BOTTLENOSE DOLPHINS (*TURSIOPS TRUNCATUS*) FROM THE LIGURIAN SEA

L. Orsi Relini*, M. Cappello* and R. Poggi**

*Università degli Studi di Genova, Istituto di Zoologia,
Laboratori Biologia Marina and Ecologia Animale, Via Balbi 5, 16122 Genova, Italy

**Museo Civico di Storia Naturale, Via Brigata Liguria 9, Genova, Italy

INTRODUCTION The feeding habits of the bottlenose dolphin have recently been studied in detail in areas where natural or accidental deaths have made available hundreds of individuals for stomach content examination (Cockroft and Ross, 1990; Barros and Odell, 1990). So far as we know, in the Mediterranean, studies on feeding habits are very limited in number (Voliani and Volpi, 1990). However, it is sometimes possible to deduce information about feeding from observations of behaviour (Police, 1932; Podestà and Magnaghi, 1988).

In Liguria, the fact that the coastal waters have long been frequented by bottlenose dolphins is reflected in a famous Roman place-name: Portus delphini, the port of the dolphins, which today is known as Portofino. At the beginning of this century, bottlenose dolphins were still numerous off Portofino, as one may deduce from the fact that in the single month of May 1916, the fishermen of Camogli sent the skulls of ten specimens to the Civic Museum of Genoa (Poggi, 1986/87). In recent times, the numbers of bottlenose dolphins have declined in the Ligurian Sea, to the point where the "Centro Studi Cetacei", a national organisation that is concerned with censusing strandings and collecting study material, failed to register one single stranded bottlenose dolphin in the period from 1981 to 1989.

Since 1990, there has been a clear tendency for the species to return to those lost areas, especially around Portofino.

In the period from 1990 to 1992, six individuals were stranded, and five of these have been used for this study. The sixth stomach content comes from a young dolphin killed at a time when "musciame" was still being prepared, an activity which came to an end with the passing of the 1980 law for the protection of marine mammals.

MATERIALS AND METHODS The stomach contents were isolated at Camogli (specimen no. 1, Table 1) and, on the occasion of recent strandings, at the Civic Museum of Natural History of Genoa (spec. nos 2-6, Table 1). The nos 3-4, which had died of unknown causes had very little stomach content, made up only of fish. The remaining number, which had come to a violent end (three killed with firearms), had stomach contents respectively of 250, 273, 2,041 and 7,640 g dry weight. In this last case, the stomach isolated during dissection (wall, solid and liquid content) weighed 25 kg.

In the Marine Biology Laboratory of the Institute of Zoology, the prey were sorted out systematically, identified, and comparative collections were prepared for the purposes of species identification and weight assessment. So far as possible, the prey are indicated in terms of numbers and reconstituted biomass (Table 2).

RESULTS 223 prey were counted, comprising 24 species of fish, six species of cephalopods and one species of crustacean. In terms of biomass, crustaceans were negligible (one species less than 1 g), while fish and cephalopods were in a ratio of 7:1. Both pelagic and demersal species had been consumed.

The stomach content of the large female is of particular interest. In 55.5 kg of reconstituted biomass, the following were distinguished:

- a) a recent meal composed of three grey mullets, two sea bass, one common squid, one flying squid and one common octopus, amounting to a total of 3.5 kg;
- b) a series of fish bone remains, perhaps from one or two days before (skulls, mandibles, vertebrae, etc.), which produce a biomass (reconstituted mainly on the basis of the dental bones) of approximately 40.6 kg.
- c) a series of otoliths which produce a further biomass of 8.8 kg. The cephalopods, in the form only of beaks, correspond to a biomass of 2.54 kg. It is probable that these minute remains stay in the stomach cavities for several days.

The stomach contents of this individual indicate the consumption of coastal reef fish (Sparidae, Sciaenidae, Centracanthidae) as well as those from circa-littoral and epybathyal muddy bottoms for example *Merluccius merluccius*, *Micromesistius poutassou*. The high consumption of *Lepidopus caudatus* is probably seasonal because this mainly mesopelagic fish frequents the surface and coastal waters especially in winter. The largest weights of the ingested fish reach approximately 1 kg for *M. merluccius*, 1.5 kg for *L. caudatus* and 2.5 kg for *Dentex dentex*. This finding suggests the ability to crush the prey and/or share it with others. In fact, the number of ingested fish heads was greater than the number that could be reconstituted from the vertebral pieces.

If we compare the present findings with those of Voliani and Volpi (1990) for a specimen from Leghorn, we tentatively recognise a food preference (similar to that indicated by Cockcroft and Ross, 1990) for *M. merluccius* and *C. conger*.

ACKNOWLEDGEMENTS Our thanks go to Mrs Maria Rosa Costa and Mrs Manuela Pessina for the isolation and preservation of the stomach content of the young *Tursiops truncatus* in Camogli.

REFERENCES

- Barros, N. B. and Odell, D. K. 1990. Food habits of bottlenose dolphin in the Southeastern United States. Pp. 309-328. In *The Bottlenose Dolphin* (Eds. S. Leatherwood and R. R. Reeves). Academic Press, San Diego, California. 653pp.
- Cagnolaro, L., Cozzi, B., Magnaghi, L., Podestà, M., Poggi, R. and Tangerini, P. 1986. Su 18 Cetacei spiaggiati sulle coste italiane dal 1981 al 1986. Rilevamento biometrico ed osservazioni necroscopiche. Atti Soc. ital. Sci. nat. Museo Civ. Stor. Nat. Milano, 127: 79-106.
- Centro Studi Cetacei, 1987. Cetacei spiaggiati lungo le coste italiane. I rendiconto 1986. Atti Soc. ital. Sci. nat. Museo Civ. Stor. Nat. Milano, 128: 305-313.
- Centro Studi Cetacei, 1988. Cetacei spiaggiati lungo le coste italiane. II rendiconto 1987. Atti Soc. ital. Sci. nat. Museo Civ. Stor. Nat. Milano, 129: 411-432.
- Centro Studi Cetacei, 1989. Cetacei spiaggiati lungo le coste italiane. III rendiconto 1988. Atti Soc. ital. Sci. nat. Museo Civ. Stor. Nat. Milano, 130: 269-287.
- Centro Studi Cetacei, 1990. Cetacei spiaggiati lungo le coste italiane. IV rendiconto 1989. Atti Soc. ital. Sci. nat. Museo Civ. Stor. Nat. Milano, 131: 413-432.
- Cockcroft, V. G. and Ross, G. J. B., 1990. Food and feeding of the Indian Ocean bottlenose dolphin off Southern Natal, South Africa. Pp. 295-308. In *The Bottlenose Dolphin* (Eds. S. Leatherwood and R. R. Reeves). Academic Press, San Diego, California. 653 pp.
- Podestà, M. and Magnaghi, L., 1988. Avvistamento di Tursiopi, *Tursiops truncatus* (Montagu, 1821), in prossimità della costa ligure (*Mammalia, Cetacea*). Atti Soc. ital. Sci. nat. Museo Civ. Stor. Nat. Milano, 129: 393-395.

Poggi, R., 1986-87. I Delphinidae fatti pervenire al Museo di Genova tra il 1914 e il 1917 dal sindacato peschereccio ligure-sardo. *Annali Museo Civ. Stor. Nat. G. Doria*, 36: 1-11.

Police, G., 1932. Il *Delphinus delphis* e la sua utilizzazione nella pesca nel Golfo di Napoli. *Boll. Pesca Piscic. Idrobiol.*, 8: 360-379.

Voliani, A. and Volpi, C., 1990. Stomach content analysis of a stranded specimen of *Tursiops truncatus*. *Rapp. Comm. int. Mer Médit.*, 32: 238.

Table 1 Specimens on which stomach content analysis was performed

NUMBER	LOCALITY	DATE	SEX	TOTAL LENGTH cm	WEIGHT Kg
1	Camogli	31-5-77	indet.	-	70
2	Alassio	13-3-90	F	281	250
3	Tino Isle	27-5-90	M	244	112
4	Spotorno	20-6-91	F	280	-
5	Portofino	27-2-92	F	232	185
6	Nervi	22-3-92	F	274	200

Table 2 Stomach content in *Tursiops truncatus*: prey species, number in examined specimens. No. 1-6, total prey number, percentage number, estimated weight, percentage weight, nq = not quantified

PREY SPECIES	BOTTLENOSE DOLPHIN						PREY NUMBER	%N	WEIGHT	%W
	1	2	3	4	5	6				
FISHES										
<i>Merluccius merluccius</i>		35		1		2	38	17,040	13275	21,400
<i>Micromesistius poutassou</i>		33					33	14,798	3313	5,340
<i>Spicara sp.</i>		28					28	12,556	1203	1,939
<i>Boops boops</i>		10			10	3	23	10,314	2860	4,610
<i>Lepidopus caudatus</i>		19					19	8,520	10654	17,175
<i>Diplodus puntazzo</i>		7					7	3,139	2016	3,249
<i>Trachurus sp.</i>		6			2		8	3,587	1279	2,061
<i>Conger conger</i>		5		2	1	1	9	4,035	7380	11,897
<i>Liza sp.</i>		4					4	1,794	1881	3,032
<i>Diplodus vulgaris and/or sargus</i>		4					4	1,794	1160	1,870
<i>Dentex dentex</i>		2					2	0,897	4000	6,448
<i>Dicentrarchus labrax</i>		2					2	0,897	880	1,418
<i>Lithognathus mormyrus</i>		2					2	0,897	180	0,290
Sciaenidae		2					2	0,897	nq	-
<i>Diplodus annularis</i>		1					1	0,448	200	0,322
<i>Pagellus erythrinus</i>		1					1	0,448	750	1,209
<i>Pagellus acarne</i>		1					1	0,448	300	0,483
<i>Sparus aurata</i>		1					1	0,448	1000	1,612
<i>Aspitrigla obscura</i>					1		1	0,448	30	0,048
<i>Syngnathus sp.</i>	+						nq	-	nq	-
<i>Spondyliosoma cantharus</i>		1					1	0,448	100	0,161
<i>Simphodus tinca</i>		1					1	0,448	100	0,161
<i>Gaidropsarus sp.</i>		1					1	0,448	70	0,112
<i>Belone sp.</i>		1					1	0,448	500	0,806
Unidentified fish		+	+	+	+	+	nq	-	nq	-
total fish							190	85,197	53131	85,643
CEPHALOPODS										
<i>Loligo vulgaris</i>			6		4	8	18	8,071	6173	9,951
<i>Ancistroteuthis lichtensteini</i>		5					5	2,242	183	0,295
<i>Todarodes sagittatus</i>		4	1				5	2,242	2303	3,712
<i>Onychoteuthis banksi</i>		1					1	0,448	20	0,032
<i>Abralia veranyi</i>						1	1	0,448	1,5	0,002
<i>Octopus vulgaris</i>			2				2	0,897	220	0,355
total cephalopods							32	14,348	8900,5	14,347
CRUSTACEANS										
<i>Meganycitiphanes norvegica</i>					1		1	0,448	0,5	-
total							223	99,993	62032	99,990

**FOOD HABITS OF *STENELLA COERULEOALBA* IN THE WESTERN
MEDITERRANEAN DURING THE 1990 DIE-OFF,
WITH SPECIAL REFERENCE TO SQUIDS**

C. Blanco, F. J. Aznar and J.A. Raga

Departamento de Biología Animal, Universidad de Valencia,
Dr. Moliner 50, 46100 Burjasot, Valencia, Spain

INTRODUCTION The striped dolphin *Stenella coeruleoalba*, is the most common cetacean species in the Western Mediterranean, particularly in its northern half. However, studies on the feeding ecology of this species in the area are scarce. This study shows new data about diet and feeding strategies of this odontocete species in the Mediterranean.

MATERIALS AND METHODS The animals used in this study were affected by a viral infection in 1990 which caused an epizootic throughout the Mediterranean Sea (Aguilar and Raga, 1993). The analysis was based on 26 stranded dolphins (15 males and 11 females) in the Spanish Mediterranean coast between 40°25'N, 0°32'W and 37°35'N, 0°45'E. The strandings occurred from 23 August to 31 September, 1990. Stomachs were stored deep frozen (-20° C) and the contents of each stomach compartment were collected, and flushed through stalked sieves of 0.4-0.2 mm mesh. Material collected was preserved in 70% ethanol.

RESULTS AND DISCUSSION Only one of the 26 stomachs studied was empty (vacuity index of 3.8%). Cephalopods occurred in 92.6% of the animals, while fishes occurred in 62.9%. The majority of the dolphins with food remains (55.5%) showed a mixed diet of squid and fish, and 37.0% of squid only.

Five hundred and twenty-four beaks belonging to 15 cephalopod species were identified (see Table 1). The most important species - *Abraliopsis pfefferi*, *Onychoteuthis banksii*, *Todarodes sagittatus* and *Brachioteuthis riisei*, corresponded to the four families most represented in the diet. The distribution of species in relation to the geographical location of the strandings seemed homogeneous, with the exception of *B. riisei*, which was not found in animals stranded south of 39° 52'N, and *Abralia veranyi*, whose northern limit was 39° 38'N. These data are in closer agreement with those from other *Stenella* species in the eastern tropical Pacific (Perrin *et al.*, 1973) than those known in Mediterranean striped dolphins (Wurtz and Marrale, 1991) or from the North-west Pacific Ocean (Miyazaki *et al.*, 1973).

Cephalopods show a variable caloric value because of their different body composition. Species with high ammoniacal levels have generally lower energetic values than those with muscular bodies. The high presence of ammoniacal squids in the diet agrees with the results inferred by us from data of other Mediterranean striped dolphins (Wurtz and Marrale, 1991). On the other hand, the general size distribution of squids clearly shows a more frequent ingestion of individuals of 60-70 mm mantle lengths.

The importance of cephalopods with luminous organs in the diet of the striped dolphin has been noticed in the literature, and might indicate that the striped dolphin, in addition to echolocation, may use vision for prey capture, as shown in other cetaceans (Clarke, 1986). The preference for pelagic or bathipelagic and oceanic species conforms with information from other *Stenella* spp. Most of the cephalopod species also undergo daily vertical migrations.

CONCLUSIONS According to this study, cephalopods are the main prey of striped dolphins in Spanish Mediterranean waters during summer. The cephalopod diet is a

mixture of squid species with muscular and ammoniacal bodies, including an important amount of luminous species.

A diet comprising a majority of squid species with nocturnal vertical migrations might indicate more active feeding at night. After comparison with the literature, the diet of the striped dolphin seems to be opportunistic, with cephalopods playing a variable role. There is a high variability in the composition of species, possibly related to their availability and natural fluctuations in numbers. This cetacean species, like others of the same genus, mainly feeds on oceanic (pelagic or bathipelagic) cephalopod species.

ACKNOWLEDGEMENTS This study was supported by the Generalitat Valenciana, ICONA and CICYT of the Spanish Government (projects NAT90-1254E and NAT91-1128-1).

REFERENCES

- Aguilar, A. and Raga, J. A. 1993. The striped dolphin epizootic in the Mediterranean Sea. *Ambio*, 22 (8): 524-528.
- Clarke, M. R. 1986. Cephalopods in the diet of odontocetes. Pp. 181-231. In *Research on dolphins*. (Editors M.M. Bryden & R. Harris). Clarendon Press, Oxford. 478 pp.
- Desportes, G. 1985. *La nutrition des odontocetes en Atlantique Nord-Est (Côtes Françaises, Iles Feroë)*. Ph. D. Thesis, Université de Poitiers. 190 pp.
- Miyazaki, N., Kusaka, T. and Nishiwaki, M. 1973. Food of *Stenella coeruleoalba*. *Sci. Rep. Whales Res. Inst.*, 25: 265-275.
- Perrin, W. F., Warner R. R., Fiscus, C. H. and Holts, D. B. 1973. Stomach contents of porpoise, *Stenella* spp., and yellow tun *Thunnus albacares*, in mixed species aggregations. *Fish. Bull.*, 4: 1077-1092.
- Wurtz, M. and Marrale, D. (1991). On the stomach contents of striped dolphins (*Stenella coeruleoalba*, Meyen 1933) from the Ligurian coast, Central Mediterranean Sea. Pp. 62-64. In *European Research on Cetaceans - 5* (Ed. P.G.H. Evans). Proc. 5th Conf. ECS, Sandefjord, Norway. 21-23 February 1991. European Cetacean Society, Cambridge.

Table 1 Estimated cephalopod prey number (n), wet weight (W), frequency of occurrence (F.O.) and index of relative importance: IRI and IRI* (see Desportes, 1985). The mode of lower rostral length (LRL) and the estimated mantle length (ML) of each species are also given.

	n	W	F.O.	% n ²	% W	% F.O.	IRI	IRI*	modal LRL	ML
Enoploteuthidae										
<i>Abrialopsis pfefferi</i>	129	1334.7	13	24.6	8.1	52.0	1701	13.6	1.4-1.6	52.8
<i>Ancistrocheirus leaueuri</i>	14	1884.7	8	2.6	11.4	32.0	452	7.4	2.8-3.0	76.8
<i>Abrialia veranyi</i>	11	211.5	5	2.1	1.3	20.0	67	3.7	1.2-1.4	3.7
Onychoteuthidae										
<i>Onychoteuthis banksii</i>	98	4089.7	9	18.7	24.8	36.0	1567	12.7	1.8-2.0	87.0
Ommastrephidae										
<i>Todarodes sagittatus</i>	28	2570.2	15	5.3	15.6	60.0	1257	12.9	3.0-3.2	116.8
<i>Todaropsis eblanae</i>	26	2312.9	8	4.9	14.0	32.0	608	8.2	3.2-3.4	105.3
Brachioteuthidae										
<i>Brachioteuthis riisei</i>	115	185.0	10	21.9	4.7	40.0	1068	10.6	2.4-2.6	66.7
Octopoteuthidae										
<i>Octopoteuthis sicula</i>	34	1076.9	12	7.0	6.5	48.0	653	9.8	3.4-3.6	60.2
Sepiolidae										
<i>Heteroteuthis</i> sp.	36	36.9	8	6.8	0.2	32.0	227	6.2	1.0-1.2	-
<i>Sepietta</i> sp.	3	15.1	3	0.5	0.1	12.0	8	2.0	-	-
<i>Sepioida</i> sp.	1	9.6	1	0.2	<0.1	4.0	<1	0.6	-	-
Chiroteuthidae										
<i>Chiroteuthis veranii</i>	14	505.9	7	2.6	3.0	28.0	160	5.4	3.4-3.6	97.0
Histioteuthidae										
<i>Histioteuthis</i> sp.	9	1178.8	4	1.7	7.1	16.0	142	3.9	3.8-4.0	73.0
Loliginidae										
<i>Loligo</i> sp.	2	440.6	2	0.4	2.6	8.0	24	1.7	-	-
<i>Alloteuthis</i> sp.	1	4.1	1	0.2	<0.1	4.0	<1	0.6	-	-

STOMACH CONTENTS OF SMALL CETACEANS FROM IRISH WATERS

E. Rogan, S. D. Berrow and M. Maloney

Department of Zoology, University College, Cork, Ireland

The stomach contents from small cetaceans, stranded or incidentally caught in Irish waters from 1990-93, were examined. Stomachs from 19 common dolphins (*Delphinus delphis*), 19 harbour porpoises (*Phocoena phocoena*), four striped dolphins (*Stenella coeruleoalba*), four Atlantic white-sided dolphins (*Lagenorhynchus acutus*), two white-beaked dolphins *L. albirostris* and one Risso's dolphin (*Grampus griseus*) were analysed.

Food remains were identified using otoliths and bones for fish species and beaks for cephalopods. Otoliths were used to back-calculate size of fish eaten, in an attempt to estimate prey biomass. Results are presented as frequency of occurrence and proportion of total biomass.

A comparison is made between the diet of different species and between stranded and incidentally caught individuals.

ABNORMAL MINKE WHALE CAUGHT AT WEST GREENLAND

Jette Jensen

Greenland Fisheries Research Institute, Marine Mammal Section,
Tagensvej 135, 2200 Copenhagen N, Denmark

INTRODUCTION Whalers have always been fascinated by "abnormal" whales. As early as 1839, Beale reported on a sperm whale with a deformed lower jaw. Indeed, most accounts of abnormal whales have referred to deformities in sperm whale jaws (see the review by Nakamura, 1968). Reports of abnormal baleen whales are considerably rarer. Ohsumi (1959) described a severely deformed fin whale foetus. Perhaps the most striking feature was the curved upper jaw. The rostrum had curled backwards, covering the blowholes.

Kato (1979) described an adult minke whale from the Antarctic with a deformed upper jaw, the only reported case out of several thousand minke whales taken by Japanese whaling operations in the Antarctic since 1972.

In this note, I describe the first record of an abnormal minke whale *Balaenoptera acutorostrata* caught in Greenlandic waters.

CATCH INFORMATION Greenlanders are allowed to take a limited number of minke whales under IWC (International Whaling Commission) regulations. Within this quota, the Greenland Home Rule Government allocated the settlement Ammassivik in Lichtenau Fjord on the southwest coast of Greenland (60°35'N 45°25'W) one minke whale for 1991.

On 31 August 1991, five local hunters went out in Lichtenau Fjord and caught their whale of the year, using rifles.

DESCRIPTION OF THE ANIMAL When the whale was dragged ashore for flensing, the hunters discovered that what they had taken during their hunt to be a normal minke whale, had a strange-looking head. They described it as looking "as if the whale had swum directly into a cliff".

Three photos were taken by the hunters, but unfortunately they were taken at the end of the flensing process and only show the head from rather poor angles. Figure 1 is a drawing based on the photos and shows the rostrum strongly arched, and the upper surface of the upper jaw descended at a steep angle anteriorly, somewhat reminiscent of a right whale (see Fig. 2 - a drawing of a normal minke whale for comparison).

The baleen plates were mainly yellowish white and those at the back were dark. However, according to the hunters, they were harder in texture than normal and could not easily be removed by being broken off or pulled out as usually done.

The hunters also said that both jaws appeared to have protruding lips anteriorly. With the mouth closed, the lip of the upper jaw fitted into a groove/hole in the lip of the lower jaw. Unfortunately this is not possible to see on the photos.

Apart from the shape of the head, the whale appeared to be a typical northern hemisphere minke whale in terms of its body morphology, with white bands on the flippers and a dorsal fin.

The hunters found no foetus in the 6.8 m female, and it was not lactating. In general, northern hemisphere minke whales reach sexual maturity between about 7-8 m (see Horwood, 1990), and so the whale was probably immature.

After flensing, as is normal practice, the hunters towed away the skeleton and it is now at the bottom of the fjord near the settlement. I visited Ammassivik during the summer of 1992 to see if it was possible to retrieve the skull but unfortunately it was not.

CONCLUSION Where possible, hunters should send a skin sample of all whales caught to GFRI for stock identity and other studies. They did so in this case, and in order to investigate the possibility of the animal being a hybrid, the sample was analysed to determine the species of the mother (using mitochondrial DNA); the maternal genes were from a minke whale. Analyses of nuclear DNA to determine the paternal genes has not yet been completed.

The cause of the deformity is thus still unknown. However, it seems likely that the whale is a minke whale and that the abnormal skull is the result of either a genetic disorder or damage to the foetus before the bone was fully developed. The deformity caused no feeding problems for the whale since it was in a good condition. Indeed, the hunters asserted that the meat tasted better than usual!!

ACKNOWLEDGEMENTS Thanks to Finn Larsen and Greg Donovan for commenting on the manuscript, and for suggesting additional references. Also thanks to Martine Berubé for technical assistance with the genetic analysis.

REFERENCES

- Beale, T. 1839. *The Natural history of the sperm whale*. 2nd ed. Voorst, London. 393 pages. (Reprinted in 1973 by The Holland Press, London.)
- Horwood, J.W. 1990. *Biology and Exploitation of the Minke Whale*. CRC press, Boca Raton. 238 pp.
- Kato, H. 1979. Unusual minke whale with deformed jaw. *Sci. Rep. Whales Res. Inst.*, 31: 101-103.
- Nakamura, K. 1968. Studies on the whale with deformed lower jaw, with special reference to its feeding. *Bull. Kanagawa Prefect. Mus. Nat. Sci.*, 1(1): 13-27 + xii plates.
- Ohsumi, SK. 1959. A deformed fin whale foetus. *Sci. Rep. Whales Res. Inst.*, Tokyo, 14: 145-147.

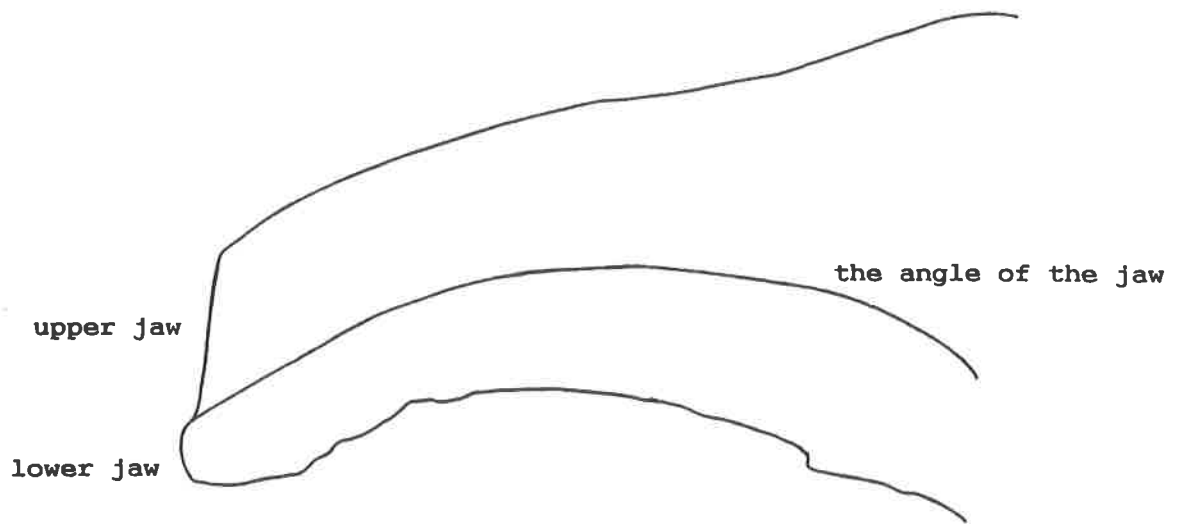

Fig. 1. Redrawing of the abnormal minke whale. The mouth is tightly closed, and the ventral grooves were removed during flensing.

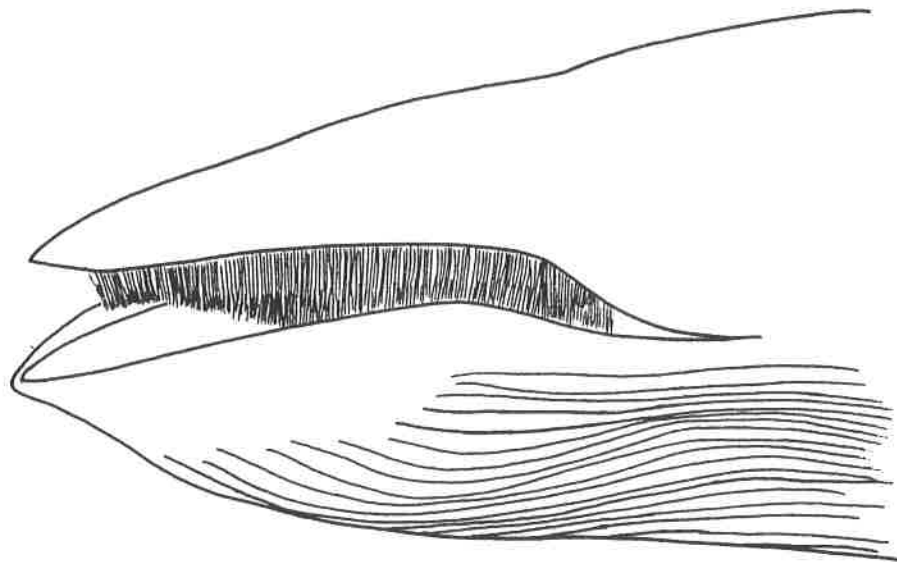

Fig. 2 A normal (but blind) minke whale with its narrow, pointed rostrum, which is a very different shape compared to what is seen on Fig. 1.

A STUDY OF THE DISTRIBUTION AND PATHOLOGY OF CETACEANS IN GREECE

E. Androukaki and E. Tounta

Hellenic Society for the Study and Protection of the Monk Seal,
Solomou 53, 104 32, Athens, Greece.

INTRODUCTION The Hellenic Society for the Study and Protection of the Monk Seal (HSSPMS) is a non-governmental, non-profit organisation established in 1988, which works mainly on the research and active protection of one of the 12 most endangered species in the world, the Mediterranean Monk Seal (*Monachus monachus*). For this purpose, the HSSPMS conducts the following activities in collaboration with national and international authorities and scientific institutes:

- Study of the biology, ecology and behaviour of the Mediterranean monk seal.
- Active protection of the National Marine Park of Alonissos N. Sporades in Greece; public awareness, surveillance of protection measures, safeguards.
- Environmental education in schools.
- Rehabilitation of orphan, sick or wounded seals.
- Organisation of a rescue and information network for the Mediterranean Monk Seal in Greece.

After the appearance of the dolphin morbillivirus (DMV) epidemic in the striped dolphin (*Stenella coeruleoalba*) in Greek waters in the summer of 1991, we started to collect data on dead cetaceans through a rescue and information network distributed throughout Greece. The striped dolphin was first infected by DMV (identified by Domingo *et al.*, 1990) in the Western Mediterranean in 1990. The virus, belonging to the family of Morbilliviridae, is related to the phocid distemper virus (PDV), which caused the death of 70% of the North sea harbour seal population in 1988 (Osterhaus & Vedder, 1988). The DMV caused immunodeficiency in striped dolphins and the animals died mainly from pneumonia and encephalitis (Domingo *et al.*, 1992).

Apart from data collected through the stranding reports related to the DMV epidemic, important information was collected on the distribution of cetaceans in Greece, a subject where very limited information is available.

METHODS A marine mammal stranding questionnaire form was prepared containing questions relating to species, location of stranding, date and time of finding, sex, length, body condition, etc. This form was distributed to 550 coastal authorities in Greece - port police, municipalities, veterinary services, fishery services and fishery co-operatives. It was also handed personally to all interested people in the areas visited by our team. Furthermore, a 24-hour phone line is available to any observer who may want to report a stranding. For the confirmation of the reports, the observers were requested to take photographs of the stranded animals, whenever possible. Despite this, the questionnaire method has disadvantages due to the low reliability of the results (Zanardelli *et al.*, 1992). These disadvantages were minimised in our study, since we used only reports from dead animals, which are easier to observe and identify.

In cases of fresh carcasses, autopsies were performed and tissue and blood samples were collected for further analysis, in order to determine the cause of death. For the virological analysis of the organ samples, the ELISA technique (Ag detection) and virus isolation techniques were used (Van Bresseem *et al.*, 1993). Blood cells from Mediterranean monk seals (*Monachus monachus*) were used, in order to determine *in vitro*, whether or not the viruses of the genus Morbilli could constitute a threat for the monk seal population (Osterhaus *et al.*, 1992).

RESULTS AND DISCUSSION In the period August 1991 - February 1994, 235 reports of stranded cetaceans were collected: 87 (37.02%) were of striped dolphins (*Stenella coeruleoalba*), 7 (2.98%) of common dolphin (*Delphinus delphis*), 17 (7.23%) of Cuvier's beaked whale (*Ziphius cavirostris*), 11 (4.68%) of bottlenose dolphin (*Tursiops truncatus*), one (0.43%) of long-finned pilot whale (*Globicephala melas*) and one (0.43%) of Risso's dolphin (*Grampus griseus*). In 111 cases (47.23%), the species was not identified unequivocally (Fig. 1).

The stranding reports collected in this way show a distinct pattern of spread of the epidemic in both time and space. (Fig. 4). Summarising the results for the whole of Greece, the peak in the number of strandings is from winter to summer 1992 (Fig. 2). After winter 1993, only sporadic deaths of striped dolphins have been reported, indicative of a probable decrease in the epidemic.

The fact that very limited information is available on the distribution and abundance of cetacean species in Greek waters, makes it difficult to evaluate death rates through this study (Fig. 3). However we get some indication on the relative importance of various habitats in the different areas. The Ionian, Crete, Dodekanese and Eastern Islands seem to be the areas with the highest frequency of cetaceans, while Cyclades is the area with the lowest.

From the total number of stranded animals, we were able to identify only 32 (13.62%) direct kills, and four (1.70%) accidental captures in nets. The low percentage of the deaths due to deliberate and accidental killing of cetaceans identified in this study, must be considered as an under-estimate. This is mainly because the fishermen do not report them due to fear of the legal consequences. Personal contacts with the fishermen suggest that the number could be much higher.

Fourteen complete autopsies have been performed by several teams (HSSPMS, Seal Rehabilitation and Research Centre of Holland, Greenpeace Greece, WWF) in Greece over the period August 1991 - April 1993. In five striped dolphins, DMV antigen was detected. In none of the cases of other species (Cuvier's beaked whale and common dolphin), was the virus detected (Van Bresse *et al.*, 1993; Osterhaus pers. comm.). From the reports collected it is evident that the species most affected by the DMV is the striped dolphin. Other cetaceans that were reported in this study or that are known to exist in Greek waters - bottlenose dolphin, Cuvier's beaked whale, long-finned pilot whale, Risso's dolphin, fin whale (*Balaenoptera physalus*), killer whale (*Orcinus orca*), sperm whale (*Physeter macrocephalus*), harbour porpoise (*Phocoena phocoena*) and others (Cebrian *et al.*, 1992; Politi *et al.*, 1993) did not appear to exhibit increased mortality due to the DMV epidemic.

For two stranded, sick striped dolphins veterinary care was given: once in Aegina in November 1991 and once in Zakynthos in November 1992. In both cases, the animals died within 72 hours. The virological analyses showed that both had died from the DMV disease, with symptoms related to pneumonia and encephalitis. (Osterhaus *et al.*, pers. comm.).

Lastly, it has been shown in vitro (Osterhaus *et al.*, 1992) that DMV can affect bottlenose dolphin cells, but not the cells of the Mediterranean monk seal and the harbour seal. However, the data collected in this study did not show a high incidence of deaths in this dolphin species. Although there are no indications that DMV is a direct threat for the Mediterranean monk seal, an epizootic by another morbilli virus (such as phocid distemper virus or canine distemper virus) can be a danger for this species. The fact that hooded seals (*Cystophora cristata*) affected by a morbillivirus have appeared in the Mediterranean (Osterhaus, unpubl. observation), makes the existence of an emergency conservation programme for the Mediterranean monk seal imperative.

ACKNOWLEDGEMENTS We would like to thank S. Admantopoulou, A. Kottas and R. Klabatsea for their help in preparing the presentation; the port police, fishery and veterinary authorities, the Ministry of Environment, the Rhodes Hydrobiological Station, Greenpeace Greece and all the people who contributed in the information collection; the Seal Rehabilitation and Research Centre (SRRC) and A.D.M.E. Osterhaus and his co-workers for their help in the autopsies and the analysis of the samples.

Part of the above study was financed by the EEC through the contract no 4-3010 (92) 7829 and the SRRC.

REFERENCES

- Cebrian, D. and Papkostantinou, C. 1992. Distribution of cetaceans in Greece, 1990-1992. Unpubl. Report.
- Domingo, M., Ferrer, L., Pumarola, M. and Marco, A. 1990 Morbillivirus in dolphins. *Nature*, Lond., 348: 21.
- Domingo, M., Visa, J., Pumarola, M., Marco, A. J., Ferrer L., Rabanal R. and Kennedy S. 1992. Pathologic and Immunocytochemical Studies of Morbillivirus Infection in Striped Dolphins *Stenella coeruleoalba*. *Vet. Pathol.*, 29: 1-10.
- HSSPMS 1993. Continuation of Establishment of a Rescue Network for Orphan, Wounded and Sick Seals and Gathering of Seal Observations from the whole of Greece. April 1992 - March 1993. Progress Report to the EEC of contract no 4-3013 (92) 7829 Pp. 1-15 + Appendix.
- Osterhaus, A. D. M. E. and Vedder, E. J. 1988. Identification of virus causing recent seal deaths. *Nature*, Lond., 335: 20.
- Osterhaus, A. D. M. E., Visser, I. K. G., De Swart, R. L., Van Bresseem, M. F., Van der Bilt, M. W. G., Orvell, C., Barret, T. and Raga, J. A. 1992. Morbillivirus threat to Mediterranean Monk seals? *Vet. Rec.*, 130: 141-142.
- Politi, E., Bearzi, M., Notarbartolo di Sciara, G., Cussino, E. and Gnone, G. 1992. Distribution and Frequency of Cetaceans in the waters adjacent to the Greek Ionian islands. Pp. 75-78. In *European Research on Cetaceans - 6* (Ed. P.G.H. Evans). Proc. 6th Ann. Conf. ECS, 20-22 February 1992, San Remo, Italy. European Cetacean Society, Cambridge, UK.
- Van Bresseem M. F., Visser I. K. G., De Swart, R. L., Orvell, C., Stanzani, L., Androukaki, E., Siakavara, K. and Osterhaus A. D. M. E. 1993. Dolphin Morbillivirus infection in different parts of the Mediterranean sea. *Arch. Virol.*, 129: 235-242.
- Zanardelli, M., Notarbartolo di Sciara, G. and Acquarone, M. 1992. Cetacean sighting report by amateurs: A two sided coin. Pp. 79-82. In *European Research on Cetaceans - 6* (Ed. P.G.H. Evans). Proc. 6th Ann. Conf. ECS, 20-22 February 1992, San Remo, Italy. European Cetacean Society, Cambridge, UK.

Fig. 1 Frequency of cetacean species in reported strandings

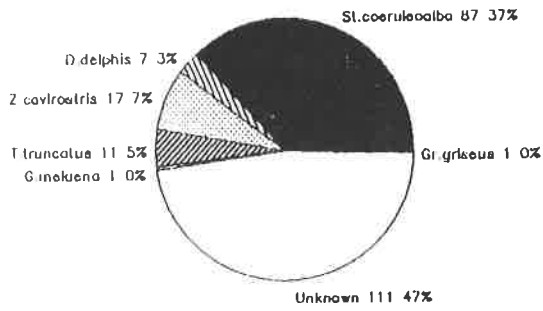

Fig. 2 Time of occurrence of striped dolphin strandings in Greece

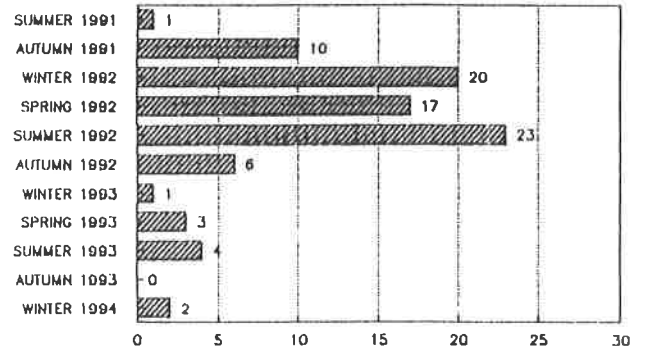

Fig. 3 Geographical distribution of stranded cetaceans

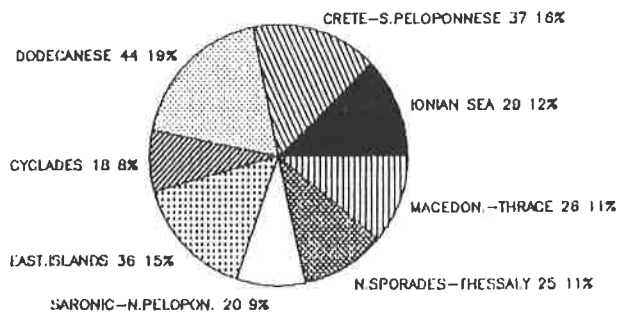
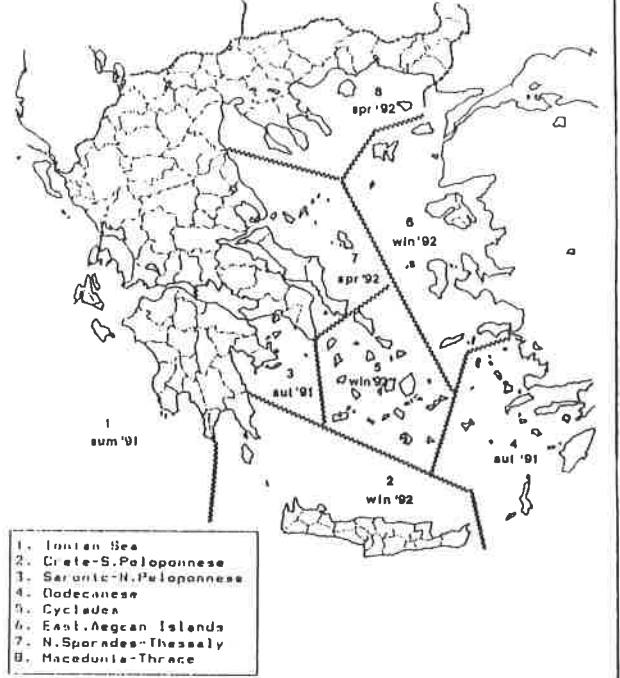

Fig. 4 Geographical pattern of appearance of DMV epidemic in Greek waters



AN OUTBREAK OF MORBILLIVIRUS DISEASE IN ATLANTIC BOTTLENOSE DOLPHINS OF THE GULF OF MEXICO

T. P. Lipscomb* and S. Kennedy**

*Department of Veterinary Pathology, Armed Forces Institute of Pathology, Washington, D.C. 20603-6000, U.S.A.

**Department of Agriculture for N. Ireland, Veterinary Sciences Division, Stoney Road, Stormont, Belfast, N. Ireland

On 5 June 1993, a free-living adult female Atlantic bottlenose dolphin (*Tursiops truncatus*) was found dead in shallow water near Panama City, Florida. Pathologic and immunocytochemical findings indicate that while the immediate cause of death was disseminated aspergillosis, the dolphin also had morbillivirus-induced disease.

Since this initial case, one bottlenose dolphin with morbillivirus disease has been identified on the Mississippi coast and five additional cases have been found in the vicinity of Mobile Bay, Alabama, bringing the total of confirmed cases in the Gulf of Mexico to seven. Histologic lesions attributed to morbillivirus infection include proliferate interstitial pneumonia with syncytial cells and eosinophilic intranuclear and intracytoplasmic inclusion bodies, lymph node syncytial cells, and intracytoplasmic inclusion bodies in transitional epithelial cells of the urinary bladder; morbillivirus has been demonstrated within these and other tissues by an immunoperoxidase technique. Additionally, five of the seven morbillivirus-infected dolphins had concomitant aspergillosis suggesting that morbillivirus-induced immunosuppression may predispose bottlenose dolphins to secondary fungal infections.

In Alabama and Mississippi, the strandings of bottlenose dolphins with morbillivirus disease coincide temporally with significantly elevated bottlenose dolphin stranding rates. Previous serological studies of Gulf bottlenose dolphins have indicated that only a small proportion have antibodies to morbillivirus; thus, the potential exists for a major morbillivirus epizootic among dolphins in the Gulf of Mexico.

**A REVALUATION OF THE UNITED STATES 1987-88 ATLANTIC
COAST BOTTLENOSE DOLPHIN MORTALITY EVENT
WITH EVIDENCE FOR A VIRAL ETIOLOGY**

F. Y. Schulman*, T. P. Lipscomb* and S. Kennedy**

*Department of Veterinary Pathology, Armed Forces Institute of Pathology,
Washington, D.C. 20603-6000, USA

**Department of Agriculture for N. Ireland, Veterinary Sciences Division,
Stoney Road, Stormont, Belfast, N. Ireland

Beginning in New Jersey in June 1987 and extending southward to Florida, over the next eleven months, over 740 Atlantic bottlenose dolphins (*Tursiops truncatus*) washed ashore. It is estimated that approximately 2,500, representing one half of the inshore population of bottlenose dolphins, died.

A government-sponsored investigation concluded that brevetoxin, a "red-tide" neurotoxin, was the most cause of the mortality. There are several problems with this theory. There was no red tide that coincided geographically and temporally with the event and no associated mortality of other species known to be susceptible to brevetoxin. Brevetoxin is not known to cause the lesions found in the dolphins. The assay used to identify brevetoxin has been found to be unreliable.

Another proposed cause for the dolphin mortality is anthropogenic contaminants. While high levels of anthropogenic toxins were present in some of the dolphins, these levels are generally similar to those found in captive dolphins. Evidence supportive of a primary role for toxins has not been presented. The epidemiology is most consistent with a viral infection, i.e. beginning at one location, spreading geographically over time, and affecting large numbers of only one species.

A review of specimens collected during this mortality event revealed histologic and immunohistochemical evidence of morbillivirus disease in a significant number of the dolphins.

**HERPES VIRUS INFECTION OF THE GENERAL TRACT IN
HARBOUR PORPOISE *PHOCOENA PHOCOENA***

H.M. Ross*, R.J. Reid*, F.E. Howie** and E.W. Gray***

*SAC Veterinary Services, Drummondhill, Stratherrick Road, Inverness, IV2 4JZ, UK

**SAC Veterinary Services, Bush Estate, Penicuik, Midlothian, EH26 0QE, UK

***ADRA, Moredun Research Institute, 408 Gilmerton Road, Edinburgh, EH17 7JH, UK

Post-mortem examinations of cetaceans found stranded around the Scottish coast have revealed a disease of harbour porpoise (*Phocoena phocoena*) in which there are focal, raised epithelial lesions in the cervix of females and on the penis of males.

Histopathological examinations have shown the presence of viral inclusion bodies in affected epithelial cells and the presence of virus particles with typical herpes virus morphology has been confirmed by electron microscopy.

The comparative pathology of herpes virus infection of the genital tract in this and other species will be discussed and its importance in relation to reproductive success will be reviewed in the light of on-going studies of other infectious agents of the cetacean reproductive tract.

METHODOLOGICAL APPROACHES TO MONITOR ORGANOCHLORINE POLLUTANTS AND THEIR EFFECTS IN CETACEANS

A. Aguilar

Department of Animal Biology, Faculty of Biology,
University of Barcelona, 08071 Barcelona, Spain.

Surveys on pollutants in cetaceans are usually devoted to one of these three objectives:

- 1) monitoring pollutant exposure of a given species or population;
- 2) establishing the interspecific, intraspecific, or intrapopulation patterns of variation of pollutant exposure and levels; and
- 3) determining the effects of pollutants in a species or a population.

These three objectives are interrelated, and proper design of surveys and control of significant ecological and biological variables are essential to ensure reliability of results and correctness in their interpretation.

The main factors known to affect pollutant loads and effects in cetaceans are identified, together with advantages and drawbacks of the various approaches to conduct surveys focused on this subject. This includes consideration of sampling methodology, selection of the pollutant, pollutant index, or pollutant response to monitor, and limitations and potentials in the interpretation of results.

**THE STUDY OF DOLPHIN CONTAMINATION:
THE NEED TO IMPROVE THE DEFINITION OF OBJECTIVES
AND METHODOLOGICAL APPROACHES IN ORDER TO
ATTAIN CONCRETE SCIENTIFIC INTEREST**

J.M. André

Université de Pau & Pays de l'Adour, Département de Biologie Appliquée,
IUT de Mont de Marsan, Rue du Ruisseau, 40000 Mont de Marsan, France

Because of their position at the top of the food chain, their long life span, and their specialised adaptations to a marine lifestyle, delphinids are considered as particularly interesting biological material for ecotoxicological studies. However, confronted with many restrictions associated with sampling difficulties due to economic, technical and legal reasons, many authors have only published occasional studies on dolphin's contamination by trace elements. Thus, amongst the previous works published in this field, only a few of them had sufficient samples and biological and ecological information at their disposal, to enable them to conduct a thorough study supported by a statistical approach. Nevertheless, the collection of a "suitable" sample is far from being the only difficulty met in this field of research. As with many ecotoxicological approaches "in situ", the study of the bioaccumulation of trace elements is confronted with the following problems: (i) the number and complexity of the influence of environmental factors; (ii) the lack of knowledge concerning the biology and physiology of the studied organisms; (iii) the uncertainty surrounding the physico-chemical behaviour of the elements analysed.

One must separate the two ways of obtaining samples for dolphin contamination studies: (i) occasional surveys: these involve groups of dolphins very often limited in numbers, from one to five. Specimens studied are often stranded dolphins. The organs and tissue samples are very few. Biological information such as age, body or organ weight, and the cause of death, is generally difficult to determine due to either the poor preservation of the specimens, or to difficult working conditions in the field. The scientists involved are not always the necessary specialists, but often are people who have found themselves in the fortunate position of having been offered these types of biological samples; (ii) full research programmes: we know that these are very few and concern a relatively large number of individuals.

What position should one adopt concerning these possibilities? Due both to the rarity of this type of biological material and to all the difficulties related to the organisation of large research programmes, we have to consider the occasional studies with a particular interest. They represent a palliative to the deficiency of more structured studies. Nevertheless, the accumulation of such sparse data will not be useful if they do not correspond to some minimal quality criteria, with common specifications. It is important that these latter should allow further comparative studies.

What parameters should constitute the list of specifications required ? We consider that each author should mention:

- Biological information: number of individuals, sex, species, total length, are easy to collect. The age can be determined by counting tooth layer groups. These delicate tasks would have to be delegated to specialised laboratories (this will have to be determined);
- Organs and tissues to be sampled: a list will have to be established, with groups of organs rated in order of priority depending on the elements or contaminants studied. The protocol for sampling, manipulation and storage of the samples will also have to be established for each contaminant.
- Analytical methods. Two suggestions could be considered: (i) minimal guarantees must be given when publishing results, concerning techniques used and reference should be made to the results of intercalibration exercises; (ii) an analytical technique renowned for

its simplicity and reliability could be proposed for each element considered. Such homogeneity in the examination of the sample would guarantee the validity of the comparative approach in space (between different geographical areas), in time (between successive studies), between species, etc.

- Results: isolated results can only be of real scientific interest if they complement existing data.

Thus, the raw data should be published in a useful and comprehensive presentation. Far too often, authors only publish synthetic parameters, for instance average values, which do not have a significant further use.

The previous comments could similarly be applied to more important research programmes. However, following previous works published in that field, it seems necessary now to develop an original research subject. Despite a strong scientific interest, the weakness of the methodological approach of many works in this field currently affects their credibility. Faced with the methodological problems in our own programme of research, we have developed a method of approach and procedure for data analysis based on a particularly large sample of specimens. This has been already described in previous publications (see André *et al.*, 1990a,b,c; André *et al.*, 1991; Calmet *et al.*, 1992; André *et al.*, in press). It has allowed us to go beyond the simple establishment of contamination levels, and to reveal and quantify the actions of the different factors taken into account.

The continuation or even the development of this type of research depends on our capacity to define coherent objectives which will open the door for a solid scientific perspective, making necessary the establishment of a common method of approach. There are numerous possibilities for the development of future research programmes. Nevertheless, these will still rely on obtaining convenient biological material and, particularly, fresh samples for histological and cytological studies, electronic microscopy and genetics.

REFERENCES

- Andre, J. M., Ribeyre, F. and Boudou, A. 1990a. Relations entre l'âge, la longueur totale, le poids total et le poids des organes chez trois espèces de dauphins de la zone tropicale Est de l'Océan Pacifique. *Mammalia*, 3: 479-488.
- Andre, J. M., Ribeyre, F. and Boudou, A. 1990b. Mercury contamination levels and distribution in tissues and organs of delphinids (*Stenella attenuata*) from the eastern tropical Pacific, in relation to biological and ecological factors. *Mar. Env. Res.*, 30: 43-72.
- Andre, J. M., Amiard, J. C., Amiard-Triquet, C., Boudou, A. and Ribeyre, R. 1990c. Cadmium contamination of tissues and organs of delphinid species (*Stenella attenuata*) - influence of biological and ecological factors. *Ecotox. Env. Safety*, 20 (3): 290-306.
- Andre, J. M., Boudou, A., Ribeyre, F. and Bernhard, M. 1990d. Comparative study of total mercury contamination of dolphins from Atlantic and Mediterranean coasts. *Sci. Tot. Environ.*, 104: 191-209.
- Andre, J. M., Boudou, A. and Ribeyre, F. 1991. Mercury accumulation in delphinidae. *Water, Air and soil pollution*, 56: 187-201.
- Calmet, D., Woodhead, D. and Andre, J. M. 1992. Pb 210, Cs 137 and K 40 in three species of porpoises caught in the Eastern Tropical Pacific Ocean. *Journal of Environmental Radioactivity*, 15 (2): 153-169.
- Andre, J. M., Amiard-Triquet, C., Amiard, J. C., Ribeyre, F. and Boudou, A. (in press) Selenium concentrations and contents in tissues and organs of dolphins (*Stenella attenuata*) from the Eastern tropical Pacific - Distribution and variation with biological and ecological factors.

**ASPECTS OF BIOLOGY AND POLLUTANT LEVELS IN
HARBOUR PORPOISES *PHOCOENA PHOCOENA*
STRANDED ON THE DUTCH COAST, 1990-1993**

M. J. Addink*, M. Garcia Hartmann**,* , C. Smeenk*,
P. Mulder*** and A. J. I. M. Verhoeven***

*National Museum of Natural History, P.O. Box 9517, 2300 RA Leiden, the Netherlands

**Seal Research and Rehabilitation Centre, Hoofdstraat 94a,
9968 AG Pieterburen, Netherlands

***Centre for Chemistry and the Environment, Leiden University, Gorlaeus Laboratories,
P.O. Box 9502, 2300 RA Leiden, Netherlands

Blubber, liver and kidney samples of 22 stranded harbour porpoises (*Phocoena phocoena*) from the Dutch North Sea have been analysed for PCBs. Levels of the planar PCBs number 77, 126 and 169 were determined within a subsample of ten animals. A thorough pathological examination of these animals took place according to an extended version of the European Cetacean Society dissection protocol for small cetaceans, and all relevant biological parameters were recorded.

The animal with the highest pollutant burden, a juvenile male, contained 19,188 ng/g blubber PCB 153. Mature females showed the lowest burdens. Based on the gross pathological examination, some frequently encountered lesions were adrenal cystic degeneration, adrenal hyperplasia and affections of the mammary glands. In a few cases, different thyroid disorders were encountered, as well as severe disease syndromes that are possibly indicative of a compromised immune response.

POLYCHLORINATED BIPHENYL CONCENTRATIONS IN STRIPED DOLPHINS *STENELLA COERULEOALBA* BEACHED ALONG THE PROVENÇAL FRENCH SEA COAST

A. Arnoux*, H. Augier**, J. L. Monod* and S. Mialon**

*Laboratoire d'hydrologie et de molysmologie aquatique,
Faculté de Pharmacie, 13385 Marseille cedex 5, France

**Laboratoire de biologie marine fondamentale et appliquée et Centre d'Etudes,
de Recherches et d'Informations sur la Mer (CERIMER),
Faculté des Sciences de Luminy, 13288 Marseille cedex 9, France

INTRODUCTION PolyChlorinated Biphenyls (PCBs) are extremely stable molecules widely used in the electrical industry and in the manufacture of plastic, paint and varnish. Their contamination of the environment is the result of sewage inputs, of accidental liquid wastes, and of emanations due to the burning of materials containing PCBs.

In the natural environment, PCBs have a tendency to adsorb onto colloidal particles and to become integrated into organic matter. They are therefore found in greater quantities in sediments and organisms than in water (Jensen, 1966). In the case of fish, concentrations between 1,000 and 100,000 times higher than in water have been found, and up to 10^8 in the case of fish-eating birds.

The high concentrations of metallic pollutants are well documented in beached dolphins found dead along the Provençal seashore (Augier *et al.*, 1991, 1992, 1993a,b, 1992). We therefore found it interesting to also investigate the PCB contents of the same samples used to determine heavy metal concentrations in these animals.

MATERIALS AND METHODS

1. Sampling Figure 1 shows the precise point of sampling of the five dead dolphins beached on the coast while the names of the collectors and the main characteristics of these cetaceans are shown in Table 1. Only melon, fat, liver, brain and muscle tissues have been analysed.

2. Preparation of the samples PCBs extraction and purifying methods are not standardised. These techniques vary with the biochemical composition of the material to analyse. In the case of the tissues of dolphins, the following procedure were used:

(a) *Preparation of the samples* The organs were stored at - 15° C in a freezer. First, they were cut into thin sections to facilitate lyophilisation. Lyophilisation took 72 hours. The lyophilised samples were reduced to powder, then homogenised. Melons and fats were not lyophilised.

(b) *Extraction* The aim was to extract the lipids from organic substances and hence the PCBs which are linked to them. A Soxhlet apparatus was used for the purpose. The powdered tissues were put at the bottom of a porous crucible. The thinly cut fat tissues were put directly into the crucibles. Hexane (99% Pestipur quality S.D.S.) was used to extract lipids and organochlorinated compounds. Constant heating coupled with a cooling column enables hexane to be changed from vapour into liquid by impregnating the crucible regularly. The siphon system of the Soxhlet then drains the hexane loaded with lipids and organo-chlorinated compounds into a balloon flask. The balloon heater brings the hexane to boiling, then the cycle repeats. The extraction time was 23 hours, which included about 276 cycles. All lipids were thus extracted.

(c) *Purification* The tissues of dolphins contain high quantities of fatty acids with long polyunsaturated chains (1/3 of total fatty acids - Grompone, 1990). A double purification was necessary in order to be able to inject the hexane phase with a minimum of impurities.

- Mineralisation of organic matter by Murphy's method (1972).

The fatty acid / alcohol bonds were broken by adding 50 ml of sulphuric acid H_2SO_4 at 96 % (36 eq/l) in a separatory funnel. Alcohols and fatty acids with short chains remained in the hydrosoluble acid phase. The acid phase was eliminated after decantation. The organic matter load required a second purification with 30 ml of H_2SO_4 . The acid phase was eliminated.

- Purification by reflux alcoholic potash.

Polyunsaturated fatty acids with long chains remained in the hexane phase. 50 ml of normal alcoholic potash were added to the solvent in a balloon flask with a cooling column. The mixture was refluxed for 30 minutes. The double bonds were broken and the hydrolysed fatty acids became hydrosoluble. We eliminated these last organic compounds by rinsing with distilled water. The pH of the hexane phase was then brought back to neutrality with 3 water rinsings.

(d) *Drying and dilutions* The last fraction of water was eliminated by pouring solvent through anhydrous sodium sulphate. The quantity of hexane was reduced to 100 ml with an evapo-rotor. The precise dilutions were then prepared in 10 ml test tubes, according to the assumed contamination of organ and to the calibration of the gas chromatograph.

(e) *Internal standard* A detectable quantity of Mirex was added to each sample. Mirex is a synthetic molecule of pesticide unknown in the environment. Mirex comes out almost last among the substances eluting from the chromatograph column and it serves as a standard. The computer coupled to the chromatograph calculates the speed at which each peak comes out relative to the speed of Mirex.

3. Analyses Analyses were carried out with a Varian 3400 gas chromatograph fitted with a capillary column of D.B.S. type and electron capture detector. The choice of congeners was based on the recommendation of Duinker *et al.*, (1988). Among the 209 congeners possible to find in commercial mixtures, seven were selected as being tracers of PCB contamination. They are the following numbers: 10, 52, 58, 118, 138, 153, and 180. The selection of congeners has taken into account the following criteria: toxicity, constant presence in the environment, preponderance in commercial mixtures, facility of identification and dosage, solubility in the lipids, and propensity for absorption to particles. The linearity of the electron capture detector was defined, thanks to a calibration experiment with IFREMER.

RESULTS AND DISCUSSION The results and the main characteristics of the analyses are listed in Table 1.

1. Importance and characteristics of PCB's identified in dolphin tissues As already mentioned, the seven PCBs congeners were chosen according to specific criteria. However, other PCBs exist. The calculation of equivalent concentrations in total PCB has taken this into account.

The results show a significant contamination by "heavy" PCBs, i.e. those containing six or more chlorine atoms, ranging from 12 to 138.6 mg/kg and varying among tissues and dolphins. Dolphin D appeared to be far less contaminated than the others. The main congeners were numbers: 118, 138, 153 and 180. This distribution is similar to the commercial mixture DP6.

This type of mixture is entirely different from what it is possible to find in sediments or suspensives. The latter have a broad spectrum of chlorinated organic molecules going from congener 28 to 180, i.e. an estimation of about 41 % of the total PCB.

In the case of dolphins situated at the end of food chains, we may consider that the light congeners have been largely metabolised, either by different organisms at lower levels of the trophic chain, or at the level of the dolphin itself. Congeners 118, 138, 153, and 180 constituted 58 % of the totality of heavy PCBs contaminating the dolphins (Abarnou *et al.*, 1986).

2. Change factors Table 1 shows significant variations among the individual dolphins as well as among the different tissues and organs that have been analysed. An effect of size and sex is, on the other hand, not obvious. This result probably comes from the fact that the number of dolphins analysed is statistically not high enough (three females and two males) and that the difference in weight and size was not considerable. However, some authors have found lower concentration in females. They explain this result by the fact that females, because of parturition and suckling, eliminate a substantial proportion of PCB. (Azieu & Duguay, 1979. Abarenou, 1986). Consequently they will have a tendency to have lower PCB loads. This was not the case for the samples analysed here.

3. Distribution of PCB's according to tissues and organs Although the analysed dolphins did not show the same degree of contamination, and in spite of the small number of samples, the variation of PCBs, concentrations among different tissues and organs was significant:

- The highest concentration was shown in the melon for all the individual dolphins.
- We found that the sub-epidermal fat showed the next highest concentrations, except for dolphin C whose hepatic tissue was more heavily charged.
- Liver tissues were third in all the samples.
- Lastly, we found the brain (except for dolphin B), and then the muscle tissues to be the least contaminated.

It would have been interesting to calculate the lipid content in the liver of dolphins A, B and D with a view to explaining their low PCB concentrations compared with the very high contamination of the melon of these dolphins. Dolphins C and E were strongly contaminated in the liver (27.2 and 30.4 ppm), even though their fats showed average concentrations similar to those of dolphins A and B.

In spite of the lipidic character of the brain, PCB concentrations were relatively low (from 1.3 to 12.2 ppm). The richness of that kind of tissue in phospholipids with a more polar tendency as well as the relative efficacy of the hemato-encephalic barrier, can explain these lower PCBs levels. The contamination of the muscles of these five animals was low, about the same as that found in the brain tissues (from 1.2 to 8.5 ppm). Muscles are poor in fat, and PCBs will have a tendency to join more hydrophobic tissues.

4. Comparison with other studies After melon and fat, the highest concentrations were found in liver, which is in accordance with the results of Alzieux & Duguay (1979). Exceptions were found for dolphins A and B which showed a low contamination of that organ (from 2.8 to 3.7 ppm respectively).

Other quantifications of PCBs in the organs of dolphins have been carried out in various laboratories. The studies of Alzieux & Duguay (1979) on marine mammals, as well as the works on the dolphins of Kerguelen Island by Abarnou *et al.* (1986) and the recent ones by Aguilar and Borrell (1991) on the striped dolphins of the Mediterranean sea are well known. However, the variations in the experimental procedure (conservation of samples, methods of purification, etc.), the diversity of the techniques of calibration and of the instruments used (capillary or glass column chromatography), make the quantitative comparison of the results rather difficult. Yet it is worth pointing out that the quantities found by Alzieux & Duguay (1979) represent an average of 266.9 ppm in the fat, with a variation of 250.7. That study was carried out on 27 samples and the results were comparable to the concentrations found in the present work.

5. Consequences of this contamination The use of the expression "low concentrations" is not appropriate because the minimum concentrations found were far from being negligible by comparison with those usually observed in the environment. For example, sea water normally contains a few ppb of PBCs and it is possible to find up to several hundreds of ppb in the sediments collected in the vicinity of the French Mediterranean sea coasts.

A study of sardines revealed contamination ranging from 0.7 to 5.1 mg/kg of fresh weight (Monod *et al.*, nd). Sardines are an important component in the diet of dolphins, so it is therefore normal to find high concentrations in marine mammals.

Various toxicological studies have shown the different effects of these substances on the Guinea pig, mainly the perturbation of the metabolism of its steroids (Kuratsone, 1972), of its calcium mechanism (Peakall 1967, Welch, 1969), and of the synthesis of carbonic anhydrase (Birman *et al.*, 1970). A depression of the immune system of mammals suffering from PCB-contamination has also been revealed (Loose *et al.*, 1977, Thomas and Hinsdill 1978; Kunita *et al.*, 1985, Brouwer *et al.* 1970).

We have also noticed the accumulation of PCB in the frontal hump of dolphins, the melon being involved in the echolocation system. On the other hand, some observations by Alzieux & Duguy (1979) suggest an upper limit of 20 ppm of lyophilised liver as the maximum acceptable for the health of the dolphins. However, a simple quantification of PCB concentrations does not allow us to conclude that this pollutant was responsible for the death of the dolphins. Biochemical, histological and anatomical studies would be necessary, but the method of collecting dolphins makes it difficult to carry them out; moreover toxicological studies are forbidden by law.

Previous works have revealed a very high contamination of these dolphins by metals and metalloids (Augier *et al.*, 1991, 1992a,b, 1993a,b,c,d, Park, 1992). Dolphins suffer from a massive toxicity because of their high trophic level and because of the diversity of pollutants present in the sea. It is likely that the added effects of these different substances may disturb their metabolism at a serious and irreversible level. In the same way, the cumulative effects and the synergistic interactions between the different toxic products are responsible for the general weakening of these mammals and this increased sensitivity is going to make dolphins prone to infections by viruses such as Morbillivirus (Dhermain, 1991, Dhermain *et al.*, 1992; Bompar *et al.*, 1991a, b).

Finally, these results once more show the danger, for sea animals, of the simultaneous concentration of remnant pollutants concentrated within the food chains in spite of the fact that these concentrations are only found in traces in the environmental water.

ACKNOWLEDGEMENTS We thank all the people who helped us for the collection and sampling of dolphins: the Fanny Observatory team (MM. Charreire, Nieri, Bellon Gravez, Jengou, Miss Dilasser, Jimenez, Pillore and Portal), and M. Bompar of the Groupe d'Etude des Cétacés En Méditerranée (G.E.C.E.M.)

REFERENCES

- Abarnou, A., Robineau, D. and Michel, P. 1986. Contamination par les organochlorés des dauphins de Commerson des îles Kerguelen. *Oceanol. Acta*, 9(1): 19-29.
- Addison, R. F. 1989. Organochlorine and marine mammal reproduction. *Can J. Fish Aquat. Sci.*, 46: 360-368.
- Aguilar, A., 1985. Compartmentation and reliability of sampling procedures in organochlorine pollution surveys of cetaceans. *Residue Rev.*, U.S.A., 95: 91-114.
- Aguilar, A., 1989. Organochlorine pollutants and Cetaceans: a perspective. Pp. 10-11. In *European Research on Cetaceans - 3*. Proc. 3rd Ann. Conf. of the ECS, La Rochelle, France, 24-26 February 1989 (Eds. P.G.H. Evans & C. Smeenk). European Cetacean Society, Cambridge.

- Allen, J. R., Carstens, L. A. and Norback, D. H. 1974. Biological effects of the Polychlorinated biphenyls in nonhuman primates. *International Symposium, Environment and Health*, N° 55, Paris, June 1974:12-16.
- Alzieu, C. L. and Duguy, R. 1978. Teneurs en composés organochlorés chez les Cétacés et Pinnipèdes fréquentant les côtes françaises. *Rapp. Assembl. Plen. Comm. Inter. Et Sci. Medit.*, Monaco: 1-5.
- Alzieu, C. L. and Duguy, R. 1979. Teneurs en composés organochlorés chez les Cétacés et Pinnipèdes fréquentant les côtes française. *Oceanol. Acta.*, 2(1): 107-120.
- Alzieu, C. L. and Duguy, R. 1981. Nouvelles données sur la contamination des Cétacés par les organochlorés. *Rapp. Assembl. Plén. Comm. Intern. Et. Sci. Medit.*, Monaco : 1-4.
- Alzieu, C., Duguy, R. and Babin, P. 1982. Pathologie des Delphinidae: contamination foetale et néonatale par les P.C.B., lésions cutanées ulcératives. *Rev. Trav. Inst. Pêches Marit.*, Fr., 46(2): 157-166.
- Andre, J. M. 1983. *Approche écotoxicologique de la contamination des Cétacés Odontocètes par le mercure et les polychlorobiphényles*. D.E.A.. Univ. of Bordeaux, France. 59 pp.
- Andre, J. M. 1988. *Recherches en écotoxicologie marine sur la contamination des Delphinidés par les micropolluants - métaux traces et composés organochlorés*. Doct. Thesis. Univ. of Bordeaux , France 282 pp.
- Augier, H. 1991. Les dauphins, un statut national de protection peu efficace. Colloque International sur "Les espèces marines à protéger en Méditerranée". Carry-le-Rouet 18-19 novembre 1989. G.I.S. Posidonie Edit. Marseille, France: 307-315.
- Augier, H. 1991. Pourquoi les dauphins viennent-ils mourir sur nos plages? *La lettre de la région, France*, 86: 8-11.
- Augier, H., Park, W.K., Ramonda, G. and Santimone, M. 1991. Menace des polluants métalliques sur les dauphins de nos rivages. Colloque International sur "Les espèces marines à protéger en Méditerranée". Carry-le-Rouet 18-19 Novembre 1989.G.I.S. Posidonie Edit. Marseille, France: 317-338.
- Augier, H., Park, W. K. and Roneau, C. 1992. Mercury contamination of the striped dolphin *Stenella coeruleoalba* Meyen from the French Mediterranean coasts. *Marine Pollut. Bull.*, G.B., 26: 306-310.
- Augier, H., Park, W. K. and Ronneau, C. 1992. Mercury, zinc and selenium bioaccumulation in tissues and organs of Mediterranean striped dolphins *Stenella coeruleoalba* Meyen. Toxicological results of their interaction. *Cellular and molecular biology, France*, 6: 621 - 634.
- Bitman, J., Cecil, H. C. and Fries, G. F. 1970. DDT, Induced Inhibition of Avian Shell Gland Carbonic Anhydrase: a Mechanism for thin Eggshells. *Science*, 168: 18-31.
- Bompar, J. M., Dhermain, F. and Poitevin, F. 1991. *Stenella coeruleoalba* affected by morbillivirus: Preliminary study for the French Continental coast of the Mediterranean. Pp. 27-31. In *Proceedings of the Mediterranean striped dolphin mortality international workshop, Palma de Mallorca* Greenpeace Public.
- Bompar, J. M., Dhermain, F., Poitevin, F. and Cheylan, M. 1991. Les dauphins de méditerranée victimes d'un virus mortel. *Recherche, France*, 22(231): 506-508.
- Borrell, A. 1989. Variation in organochlorine pollution (DDT and PCB) level in a non-preserved stranded dolphin. Pp. 24-28. In *European Research on Cetaceans -3*. Proc. 3rd Ann. Conf. of the ECS, La Rochelle, France, 24-26 February 1989 (Eds. P.G.H. Evans & C. Smeenk). European Cetacean Society, Cambridge.
- Borrell, A. and Aguilar, A. 1990. Loss of organochlorine compounds in the tissues of a decomposing stranded dolphin. *Bull. Environ. Contam. Toxicol.*, U.S.A., 45: 46-53
- Borrell, A. and Aguilar, A. 1991. Pollution by PCB in Striped Dolphins affected by the Western Mediterranean epizootic. Pp. 121-128. In Proc. Mediterranean Striped Dolphin Mortality Intl Workshop, Palma de Mallorca. Greenpeace public.
- Borrell, A. and Aguilar, A. 1991. Were PCB levels in striped dolphins affected by the western mediterranean die-off abnormally high? Pp. 14-22. In *European Research on Cetaceans -5*. Proc. 5th Ann. Conf. of the ECS, Sandefjord, Norway, 21-23 Feb 1991 (Ed. P.G.H. Evans). European Cetacean Society, Cambridge.

- Brisou, J. 1973. Recherche des pesticides chlorés dans les mammifères marins. *Ann. Soc. Sci. Nat. Char. Mar., Fr.*, 5(9): 393-396.
- Brouwer, A., Reijnders, P. J. H., and Koeman, J. H. 1989. Polychlorinated biphenyl (PCB) contaminated fish induces vitamin A and thyroid hormone deficiency in the common seal (*Phoca vitulina*). *Aquat. toxicol.*, U.S.A., 15: 99-106.
- Deschamps, P. 1986. Eléments de toxicologie et d'écotoxicologie des PCB et de certains de leurs produits de dégradation thermique in PCB, "Dioxines", "Furanes". Prévention des risques dus aux transformateurs électriques. Journée d'Information technique, CFDE (18 mars).
- Dhermain, F. 1991. Mammifères marins, l'hécatombe. *Eurovet., Fr., suppl.*, 2, 614: 1.
- Dhermain, F., Bompar, J. M., Poitevin, F., and Cheylan, M. 1992. Morbillivirus chez les dauphins bleus et blancs *Stenella coeruleoalba* de Méditerranée. Actes des 1ères Rencontres Cétologie Méditerranéenne, Port La Nouvelle, 8-9 juin 91, France: 30-33.
- Duinker, J. C., Schultz, D. E. and Petrick, G. 1988. Selection of Chlorinated Biphenyl Congeners for Analysis in Environmental Samples. *Mar. Poll. Bull.*, 19(1): 19 - 25.
- Kennedy, S. 1991. Morbillivirus infections in marine mammals. Pp. 65-73. In *Proceedings of the Mediterranean striped dolphin mortality International Workshop, Palma de Mallorca*, Greenpeace public.
- Kunita, N., Hori, S., Obana, H., Otake, T., Nishimura, H., Kashimoto, T. and Ikegami, N. 1985. Biological effects of PCBs, PCQs and PCDFs presents in the oil causing yusho and yu-cheng. *Envir. Hlth; Perspec.*, U.S.A., 59: 79-84.
- Kuratsune, M. 1972. An abstract of results of laboratory examinations of patients with yusho and of animal Experiments. *Environmental Health Perspectives.*, U.S.A: 129-136.
- Kuratsune, M., Yoshimura, T., Matsuzana, J. and Yamaguchi, A. 1972. Epidemiologic Study on Yusho, a Poisoning caused by Ingestion of Rice oil contaminated with a commercial brand of Polychlorinated Biphenyls. *Environmental Health Perspectives*, U.S.A.: 119-127.
- Loose, L.D., Pitman, K. A., Bentitz, P. and Silkworth, J. B. 1977. Polychlorinated biphenyl and hexachlorobenzene induced humoral immunosuppression. *J. Reticuloendo. Soc.*, U.S.A., 22 : 253-271.
- Mialon, S. 1993. Teneurs en PolyChloroBiphényles de cinq dauphins bleus et blancs (*Stenella coeruleoalba*) échoués le long des côtes provençales. Rapport stage I.U.T. de Perpignan. Laboratoire de biologie marine fondamentale et appliquée, CERIMER et laboratoire d'hydrobiologie et de molysmologie aquatique. Edit. Marseille. 56 pp.
- Monod, J.L., Raybaud, H., Venot, C. and Carra, G. N.D. Identifications et dosages des polychlorobiphényles (PCB° et des métabolites du D.D.T. chez la sardine (*Sardine pilchardus* L.). Rapport LHMA (Laboratoire d'Hydrologie et de Molysmologie aquatique) et Centre Océanologique de Marseille. France. 34 pp.
- Murphy, P. G. 1972. *J. Ass. Off. agric. Chem.*, U.S.A., 55: 1360-1362.
- Park, W. K. 1992. *Variation de la composition élémentaire et de la contamination métallique chez quatre bio-indicateurs (posidonies, moules, oursins, dauphins) le long des côtes provençales*. Thèse doctorat, université d'Aix-Marseille III. Fr., 294 pp..
- Peakall, D. B. 1967. *Nature.*, Lond., 216: 505.
- Peakall, D. B. 1970. p'-DDT : effect on calcium metabolism and concentration of estradiol in the blood, *Science*, 168.
- Thomas P. T. and Hinsdill, R. D. 1978. Effect of polychlorinated biphenyls on the immune responses of rhesus monkeys and mice. *Toxicol. appl. Pharmacol.*, G.B., 44:41-51

De Voogt, P. and Brikman, V. A. 1989. Production, properties and usage of polychlorinated biphenyls in halogenated biphenyls, terphenyls, naphthalenes, dibenzodioxins and related products. Elsevier Science Publishers.

Welch, R.M., Levine, M. and Conney, A.H. (Eds) *Proceedings of First. Rochester Conf. on Environmental Toxicity*. University of Rochester.

Table 1 Poly Chlorinated Biphényl concentrations ($\mu\text{g/g}$) in 5 dolphins *Stenella coeruleoalba* beached along the provençal French sea coast. (°= lyophilised samples, *= no lyophilised)

Dolphins	A	B	C	D	E
Collectors	Charreire	Charreire	Bompar	Bompar	Bompar
Date and location	29/12/88 Golfe de Fos	11/01/89 Golfe de Fos	26/10/90 Six-Fours	18/10/90 La Capte	11/10/90 Sainte Maxime
Sex	Female	Male	Female	Male	Female
Weight (Kg)	68	77	87	75	68
Length (cm)	170	175	203	185	183
Melon *	116.1	138.6	48.2	8.1	76.0
Fat *	83.2	62.2	12.4	2.7	65.5
Liver °	2.8	3.7	27.2	2.7	30.4
Brain °	3.9	3.1	11.2	1.3	12.2
Muscle °	2.5	4.3	3.6	1.2	8.5

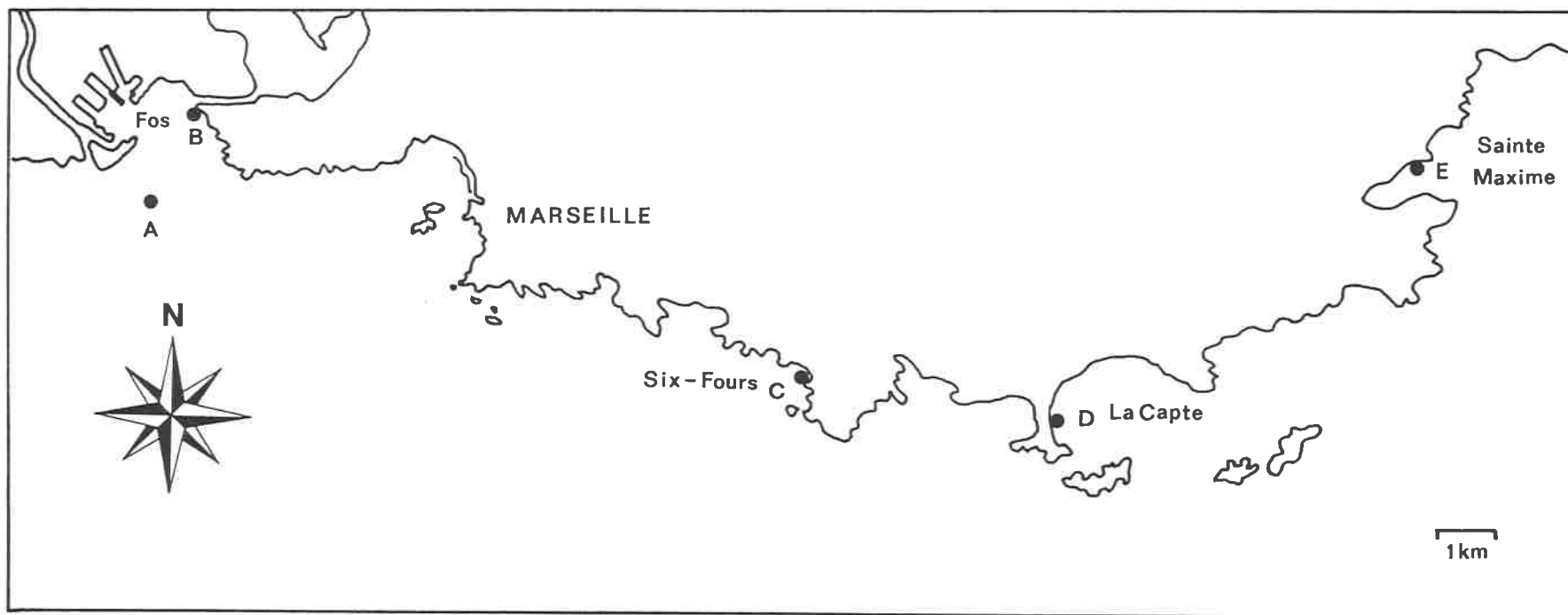

Fig. 1 Location of sampling areas of dolphins *Stenella coeruleoalba* along the French Mediterranean coast

EVALUATION OF TOXICITY AND SEX-RELATED VARIATION OF COPLANAR PCB LEVELS IN MEDITERRANEAN STRIPED DOLPHIN

A. Borrell, S. Corsolini and S. Focardi

Dipartimento Biologia Ambientale, Università di Siena,
v. delle Cerchia 3, 53100 - Siena, Italy

INTRODUCTION Coplanar polychlorinated biphenyls (PCBs) and Σ PCB concentrations in the blubber of 30 striped dolphins (*Stenella coeruleoalba* - 17 females and 13 males), collected during an epizootic that affected the Mediterranean Sea in 1990, were determined to evaluate toxicity and differences between the sexes. Non-ortho chlorinated PCB congeners and mono-ortho and di-ortho (to a lesser extent) have similar properties to TCDD, making them the most toxic members of this class of halogenated aromatics. Previous studies in other mammals have shown that these compounds cause weight loss, reproductive impairment, thymus atrophy, immune disorders, teratogenesis and Ah receptor binding (Safe, 1993). Based on these results, Safe proposed a set of Toxic Equivalence Factor (TEF) values for the non-ortho, mono-ortho and di-ortho coplanar PCB congeners (Table 1). The TEF is a measure of the relative toxicity of different compounds with respect to 2,3,7,8-TCDD, the most potent member of this family of chemicals. Although the high toxicity of coplanar PCB congeners has been clearly demonstrated, little information is available on environmental contamination and their longterm effects. Coplanar PCB congeners occur in technical mixture (Kannan *et al.*, 1987) and then they are likely to disperse in the environment in the same way as the other PCBs. They are ubiquitous and persistent and their toxic mode of action is similar to that of dioxins; in addition to this, their residue levels in environmental samples are higher than dioxins. Therefore, their bioaccumulation in the food webs and the ensuing residues in the tissues of the organism may have a great importance in the toxic risk assessment of the most harmful contaminants.

MATERIALS AND METHODS Blubber from the posterior region of the dorsal fin was excised from dolphins collected during the epizootic of 1990, wrapped in aluminum foil, and kept in the deep freezer at -20°C until analysis. PCBs were analysed by alkaline-alcohol digestion (Wakimoto *et al.*, 1971). An aliquot of hexane extract (3-6 ml) was used for non ortho-chlorinated determination, according to Tanabe *et al.* (1978). In this paper, PCB concentrations in tissues are always expressed on an extractable lipid basis. Sex and reproductive condition were determined by examination of dolphin gonads.

RESULTS AND DISCUSSION

Concentrations - Table 1 shows the mean concentrations of coplanar PCB congeners and Σ PCBs for all individuals as well as the mean values for males and females separately. Both Σ PCBs and coplanar levels were extraordinarily high compared with other cetaceans, and among the highest in the literature (Kannan *et al.*, 1989; Ford *et al.*, 1993). The results are similar to those of Kannan *et al.* (1993) in the same population. A t-test between concentrations in males and females indicated a significant difference ($p < 0.05$). Concentrations of all congeners and Σ PCBs were two times higher in males than in females (Figure 1). When each group was divided into mature and immature animals, ANOVA and the Tukey test revealed a significant difference between mature males and mature females for all congeners ($p < 0.05$). In marine mammals, organochlorine loads tend to increase with age during the juvenile stage, both in males and females, because the uptake of contaminant usually exceeds metabolism and excretion. In adult males, this pattern continues and their contaminant levels increase with age. In females, transfer of contaminants to offspring during gestation and lactation cause pollutant concentrations to decline with age (Aguilar and Borrell, 1988). The dissimilarity in organochlorine accumulation pattern between the two sexes undoubtedly explains the differences observed between males and females.

Toxicity - Toxic equivalent factors (TEFs) developed by Safe were used to calculate TCDD-equivalents (TEQ; Table 1). As we can see in Figure 2, mono-ortho congeners, and especially congener 118, had the highest TEQ concentrations. Figures 3 and 4 show the toxicity contribution of the coplanar compounds. Mono-ortho congeners accounted for 70% of the overall toxicity, whereas non-ortho and di-ortho each only contributed 15% each. Mono-ortho compound 118 contributed 42% of total toxicity. In terrestrial mammals, the percentage of the TEQ contributed by non-ortho congeners is generally much higher, about 30-40%, whereas in marine mammals, it is only 5-15% (Kannan *et al.*, 1993). This difference suggests that marine mammals have a higher capacity than terrestrial mammals to metabolise non-ortho congeners or a higher degradation rate of these compounds along complex food webs.

ACKNOWLEDGEMENTS During this survey, A. Borrell was supported by a post-doctoral fellowship from the Ministerio de Educacion y Ciencia of Spain.

REFERENCES

- Aguilar, A. and Borrell, A. 1988. Age- and sex-related changes in organochlorine compound levels in fin whales (*Balaenoptera physalus*) from the eastern North Atlantic. *Mar. Environ. Res.*, 25: 195-211.
- Ford, C.A., Muir, D.C.G., Norstrom, R.J., Simon, M. and Mulvihill M.J. 1993. Development of a semi-automated method for non-ortho PCBs: application to Canadian arctic marine mammal tissues. *Chemosphere*, 26: 1982-1991.
- Kannan, N., Tanabe, S., Ono, M. and Tatsukawa, R. 1989. Critical evaluation of polychlorinated biphenyl toxicity in terrestrial and marine mammals: increasing impact of non-ortho and mono-ortho coplanar polychlorinated biphenyls from land to ocean. *Arch. Environ. Contam. Toxicol.*, 18: 850-857.
- Kannan, K., Tanabe, S., Borrell, A., Aguilar, A., Focardi, S. and Tatsukawa R., 1993. Isomer-specific analysis and toxic evaluation of polychlorinated biphenyls in striped dolphins affected by an epizootic in the western Mediterranean Sea. *Arch. Environ. Contam. Toxicol.*, 25(2): 227-233.
- Safe, S. 1993. Polychlorinated biphenyls (PCBs), dibenzo-p-dioxins (PCDDs), dibenzofurans (PCDFs), and related compound: environmental and mechanistic considerations which support the development of toxic equivalency factors (TEFs). *Toxicology*, 21(1): 51-88.
- Tanabe, S., Kannan, K., Wakimoto, T. and Tatsukawa R., 1987. Method for the determination of three toxic non-ortho chlorine substituted coplanar PCBs in environmental samples at part-per-trillion levels. *Int. J. Environ. Anal. Chem.*, 29: 199-213.
- Wakimoto, T., Tatsukawa, R. and Ogawa T. 1971. Analytical methods of PCBs. *J. Environ. Pollut. Control*, 7: 517-522.

		NON-ORTHO PCBs			MONO-ORTHO PCBs				DI-ORTHO PCBs				ΣPCBs	
		LIP. CONT.	77	126	169	60	105	118	156	138	153	170		180
ALL	TEF		0,01	0,1	0,05	0,001	0,001	0,001	0,001	0,00004	0,00004	0,00004	0,00004	
	CONC.	0,46	0,122	0,043	0,021	1,77	7,87	18,894	3,260	102,20	146,43	46,54	62,88	855,90
	S.D.	0,16	0,075	0,025	0,014	1,25	4,99	12,52	2,370	66,28	91,54	38,59	50,10	569,04
	TCDD		1,220	4,287	1,058	1,77	7,869	18,894	3,260	2,04	2,93	0,93	1,26	331,66
FEMALE	CONC.	0,49	0,096	0,032	0,015	1,22	5,82	13,43	2,214	75,65	108,57	28,31	36,90	594,85
	S.D.	0,19	0,068	0,022	0,011	1,17	5,00	12,18	2,130	70,18	93,34	30,79	37,45	537,78
	TCDD		0,963	3,168	0,775	1,22	5,82	13,43	2,214	1,51	2,17	0,57	0,74	236,73
MALE	CONC.	0,42	0,156	0,058	0,029	2,50	10,55	26,04	4,620	136,92	195,95	70,39	96,86	1197,28
	S.D.	0,10	0,070	0,021	0,013	0,95	3,48	8,82	1,930	39,62	60,15	34,54	43,84	404,20
	TCDD		1,557	5,750	1,428	2,50	10,55	26,04	4,620	2,74	3,92	1,41	1,94	455,79

Table 1: Means and standard deviation of lipid content, concentrations (µg/g lip. wt.) and TCDD-equivalents (ng/g lip.wt.) of the coplanar PCB congeners and of ΣPCBs for all individuals (n=30) and means for males (n=13) and females (n=17).

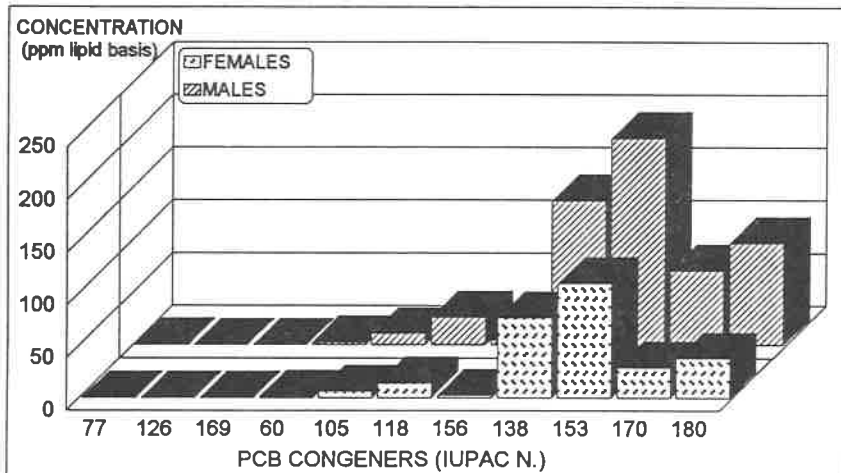

Figure 1: difference in PCB congeners concentrations between the two sexes

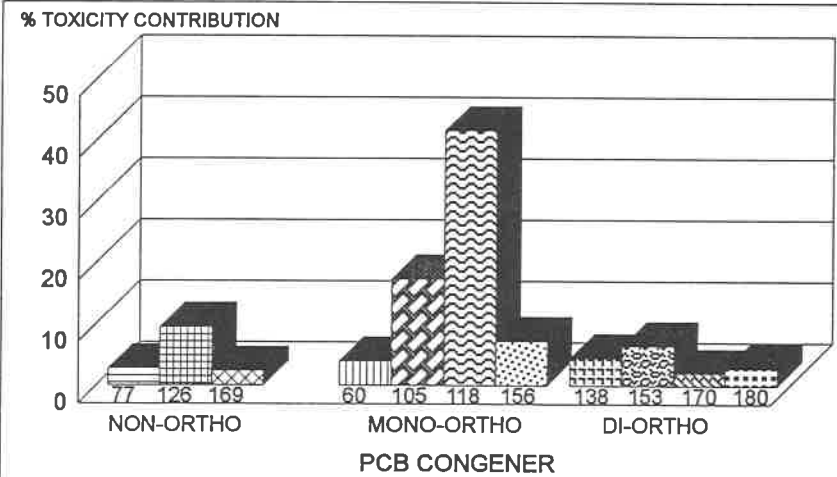

Figure 3: percentage toxicity of some planar PCBs respect to the total TEQs

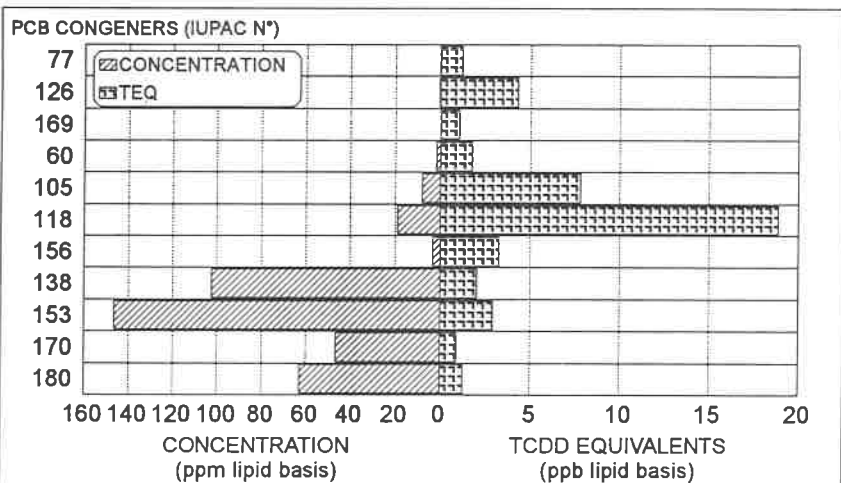

Figure 2: concentration of PCB congeners and TCDD-Equivalents

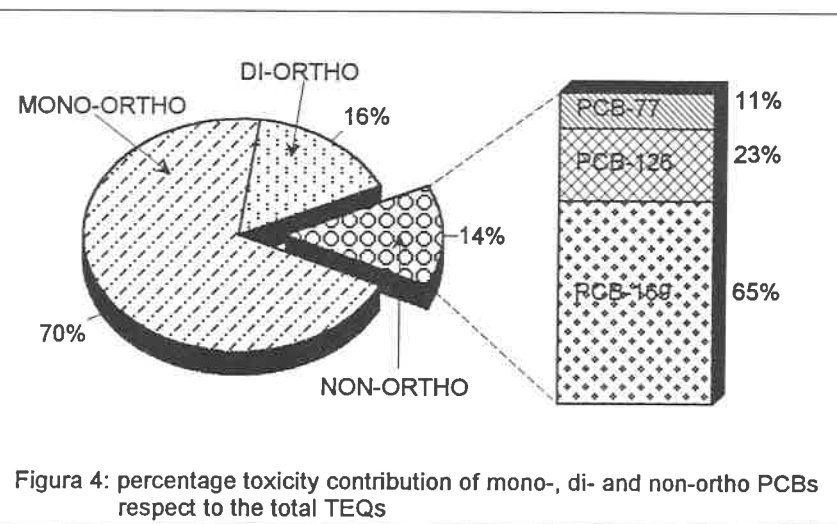

Figure 4: percentage toxicity contribution of mono-, di- and non-ortho PCBs respect to the total TEQs

**CADMIUM AND MERCURY TRANSFER DURING PREGNANCY
IN THE MARINE MAMMAL, LONG-FINNED PILOT WHALE
GLOBICEPHALA MELAS OFF THE FAROE ISLANDS**

F. Caurant* and M. Navarro**

*ERS 77 CNRS, University of Nantes, 1 rue G. Veil,
44035 Nantes Cédex, France

**Department of Nutrition and Bromatology, Faculty of Pharmacy,
University of Granada, E-18012 Granada, Spain

Cadmium (Cd) and mercury (Hg) are generally considered to be the elements most likely to give rise to pollution problems in marine ecosystems. Since they are relatively long-lived species and at the end of the food chain, marine mammals accumulate relatively high levels of metals. This is the case for the long-finned pilot whale (*Globicephala melas*) off the Faroe Islands, which exhibit high levels of Cd and Hg: respectively 50.2 and 63.5 µg/g wet weight in their liver; 74.2 and 5.3 in their kidney, 0.12 and 0.88 in their central ventral muscle.

The Faroese year-round fishery allowed us to obtain samples from the whole schools, including pregnant females and foetuses, and therefore to investigate the transfer of Hg and Cd between mothers and their foetuses. Mean levels of Cd and total Hg were respectively 0.02 and 0.82 µg/g in foetus liver. These two metals were already cumulative in foetuses. It is well known that mercury organic forms cross the placenta and reach the developing foetus.

In the adult females, the mean levels of methyl-Hg were, respectively, 4.83 and 1.79 µg/g in the liver and the muscle. In the foetuses, the mean levels of methyl-Hg were respectively 0.23 and 0.30 µg/g in the liver and the muscle.

In adult livers, most of the mercury is associated with selenium and forms tiemannite, a non-biodegradable component. In the liver of the foetuses, there was no correlation between total Hg and Se. This would indicate that the foetus is not yet able to demethylate methylmercury.

NEUTRON ACTIVATION STUDY OF THE ELEMENTARY COMPOSITION OF STRIPED DOLPHINS (*STENELLA COERULEOALBA* MEYEN) COLLECTED FROM THE FRENCH MEDITERRANEAN COAST

Augier, H.^{*,**}, Park, W. K.^{**} and Ronneau, C.^{***}

*Centre d'Etudes de Recherches et d'Informations sur la Mer (CERIMER) et Laboratoire de Biologie Marine Fondamentale et Appliquée, Faculté des Sciences de Luminy, 13288 Marseille Cedex 9, France

**Groupe d'Etude des Cétacés En Méditerranée (GECM), 344000 Montpellier, France

***Laboratoire de Chimie Inorganique et Nucléaire, Université de Louvain, B-1348 Louvain-la-Neuve, Belgium

INTRODUCTION Frequent beachings of striped dolphins (*Stenella coeruleoalba*) along the French Mediterranean coast are the object of a study which includes histopathological investigations (Augier *et al.*, 1993a) and chemical analysis for the determination of pollutants such as pesticides and heavy metals (Augier *et al.*, 1991, 1993) and elements. In the present article, the focus is on these elements.

MATERIALS AND METHODS

Sampling procedure Samples of 13 striped dolphins found dead along the French Mediterranean coasts were collected by G.E.C.E.M. (Groupe d'Etudes des Cétacés En Méditerranée) collectors, whose names are listed in Table 1. The main characteristics of the dolphins, and the locations of their discovery are indicated on a map of the region (Fig 1).

Animal dissections provided samples of blubber, muscle and skin as well as of the following organs: brain, heart, kidney, liver, lung, and testicles. Samples, cut into small pieces, were lyophilised and stored before analysis, according to Augier (1970).

Neutron-activation analysis The samples, dried out in a hot-air drying oven at 105°C for 24 hours, were then ashed at 560°C in an oven, according to Foulquier & Philippot (1982). The ashes were exposed to thermal neutron bombardment for 3 x 8h at a rate of 3 x 10¹¹ particules cm⁻² s⁻¹. Standard samples of various elements were irradiated at the same time as experimental samples. Because of the difficulties in transport between the reactor and the x-ray spectrometry laboratory, only the elements whose isotopes had a half-life of more than a few hours could be analysed (thus Al, Cl, Ge, I, In, Mg, Ti and V were excluded). Gamma spectrometry was performed on an assembly line consisting of a 80 cm³ Ge (Li) detector coupled with a 4096 channel pulse height analyser (Camberra Series 35 plus). Twenty or thirty hours after irradiation, we could detect the emission-energy decay rates of As, Au, Br, K, Na, Sm and U. The samples were then stored for approximately 20 days, and then the long life radionuclides could be identified (Ba, Ce, Co, Cr, Cs, Fe, Hg, Rb, Sb, Sc, Se, Th and Zn). Several elements could not be detected by neutron activation, because either the probability of their absorption of neutron was low (e.g., C, Cd, F, H, N, O, Pb, Sn, etc) or the radionuclides they created were not gamma emitters (e.g., Cu, P, S, Si, etc.).

Data treatment For an easy interpretation of data, three variables (individuals, metals and organs) of our results were analysed by the following mathematical and statistical treatments: correspondence analysis performed by programs according to Benzecri (1980, 1983), Legende & Legendre (1979b), Diday *et al.*, (1982), Bouroche & Saporta (1983), Lefebvre (1983) & Cibois (1987) for the visualisation of distances between metals and between organs; cluster analysis using main association as an aggregation index based on Legendre & Legendre (1979a), Benzecri (1982) for the grouping of metals and/or of organs and non parametric statistics (Mann-Whitney test and Spearman correlation in Caperaa & Van Cutsem, 1988) for the determination of significant differences.

RESULTS AND DISCUSSION

Elementary composition The following elements were identified: antimony, arsenic, barium, bromine, cerium, cesium, chrome, cobalt, gold, iron, lanthanum, uranium and zinc. We can add: cadmium, copper, lead, manganese, nickel, titanium and vanadium which were determined by atomic absorption spectrometry (Viale, 1974, 1978 ; Honda *et al.*, 1982, 1983; Capelli *et al.*, Augier *et al.*, 1991); this led to the identification of 31 elements in *Stenella coeruleoalba*. Complementary experiments using other identification methods resulted in the discovery of yet more elements. No experiment has been carried out to date to determine which elements are naturally included in the elementary composition of the dolphin and which elements are brought by pollution. We can assume, however, that arsenic, cadmium, lead, mercury, titanium and vanadium are due to pollution. It should be confirmed though, by the analysis of the tissues and organs of dolphins that they have not been in contact with polluted water nor eaten contaminated prey.

Quantitative data Identified elements can be divided into two categories (all organs, tissues and dolphins mixed):

Major elements, whose concentration is over 1 ppm and **Minor elements**, whose concentration is under 1 ppm

< 15,000 ppm: Na, K	< 0.50 ppm: Co, Ce, Cs
< 2,500 ppm: Fe	< 0.25 ppm: U, La, Th, Sb
< 1,500 ppm: Se	< 0.05 ppm: Au
< 1,000 ppm: Zn	< 0.01 ppm: Sm, Sc
< 500 ppm: Hg, Sr	
< 100 ppm: Br, Ba	
< 10 ppm: As, Cr, Rb	

Elementary shares in tissues and organs The concentration of each element varies according to the individuals and the parts considered. The results show the following classification:

- *Non-detected elements*

- . Uranium in blubber, brain, heart, kidney, liver, lung, and melon samples of all the dolphins. It is only detected in two muscle samples and one skin sample.
- . Samarium in heart, liver, lung and skin samples of all the dolphins. It is found in blubber, kidney & muscle samples from dolphin no. 9 collected at Frioul island, near Marseille; in brain samples of dolphin no. 1 (Fos-sur-Mer) and in melon samples of dolphin no. 13.
- . Barium in blubber, liver and skin samples of all the dolphins.
- . Thorium in liver and muscle samples of all the dolphins.
- . Silver in heart samples of all the dolphins.
- . Chrome and antimony in brain samples of all the dolphins.

The most elevated concentrations are found in liver for cerium, iron, mercury, selenium, and silver; in kidney for antimony and bromine; in lung for chromium, cobalt and sodium; in heart for strontium, uranium and zinc; and in muscle for caesium.

- In decreasing order of concentrations, the elements show the following affinities: *sodium* for lung, kidney & brain; *potassium* for brain, heart & muscle; *iron* for liver, lung & muscle ; *selenium*, *mercury* and *cerium* for liver, lung & kidney; *zinc* and *strontium* for skin, liver & lung; *bromine* for kidney, lung, and heart; *barium* for muscle, heart, lung; *silver* for liver & kidney; *arsenic* for heart, kidney & liver; *rubidium* for heart, kidney & muscle; *chromium* for lung, heart & muscle; *cobalt* for lung, kidney & heart; *caesium* for muscle & brain; *thorium* for melon, lung & brain; *antimony* for kidney & blubber.

Multiple correspondence analysis allows the following remarks :

- Factor 1 has the strongest positive correlation, with blubber and melon. This confirms that they are the parts of the dolphin where the concentrations of identified elements are generally low.
- The contents increase according to the elementary affinities of the organs. The most visible elements are mercury and selenium for liver, zinc for skin, and potassium and bromine for lung and kidney.

Cluster analysis shows similarities between Br and Na, between Rb and K, and particularly between Hg and Se. Applications of Spearman correlation to each organ (Table 3) also show strong positive correlations between Br and Na for all the organs and between Hg and Se for all the organs except skin. On the other hand, there is no significance, at organ level, between Rb and K.

The Mann-Whitney test applied to the ratio between Hg and Se (Table 2) and the Spearman correlation test show that skin may play an important part either in storage by internal drainage or in absorption from ambient sea water. It will certainly be difficult to check these hypotheses as well as to identify their effects at skin level. This question will be the subject of a further study.

Toxicological problems The presence of important quantities of selenium, mercury, iron, zinc, strontium, bromine, silver, arsenic and rubidium, particularly in vital organs such as liver, kidney, lung, heart, and often brain, raises certain toxicological problems. Due to the absence of experimental *in vitro* contamination, which is incompatible with our laboratory ethics and prohibited by law anyway, lethal doses are not known in this domain. Therefore, it is difficult to estimate the consequences of the presence of these metals and of toxic metalloids on the health and death of the dolphins. An example of the relationship between Hg and Se reveals how complex it is. Our estimates of mercury contents are too high compared with the maximum admissible mercury dose of 0.5 ppm and 0.7 ppm fresh weight for sea products and tuna fish respectively. There exist references where significantly lower mercury contents have induced serious damage to hepatic, renal and encephalic tissues (Fowler, 1972; Singhal *et al.* 1974; Nordberg, 1976). We cannot say, however, that these results entirely prove that mercury concentration caused the death of those dolphins. A detoxication action of selenium is indeed possible.

In fact, Martoja and Viale (1977) emphasised numerous Hg-Se concretions in conjunctive tissues of odontocetes by microscopic and cytochemical methods. The concretions are not biodegradable and therefore eliminate the toxicity of each metal in the contaminated individual, as well as in any predators (Martoja and Martoja, 1985). The process of Hg-Se formation in marine mammals for organic and inorganic Hg has been taken up by Pelletier (1985). According to Thibaud (1978), it is a defence mechanism against mercury which is also found in tuna fish. The simultaneous presence of mercury and selenium was also noted in the main organs of Atlantic, Adriatic and Tyrrhenian *Stenella coeruleoalba*.

We hope to improve our knowledge of the subject through the histopathological research programs that we have just carried out.

How is it possible to find such toxic levels for various elements in dolphins? The first explanation concerns food-chains. It is this phenomenon that was at the origin of the historical Minamata drama (O.C.D.E., 1974 ; Gigon, 1975 ; O.M.S., 1979). So we analysed stomach contents (Augier *et al.*, 1991). Their heavy metal concentrations were sufficiently in accordance with the common rule of a build-up to the highest stages in the trophic chain. We must also take into account the fact that elements are residual and accumulate in tissues and organs.

Two other means of contamination, via sea water, are ingestion and transdermal penetration. Viale (1974) supposed that, due to its particular structure and dense vascular network, the skin of the dolphin would be a means of transport for the pollutants existing in

sea water. It must be noted that there may also be penetration through the respiratory organs (André *et al.*, 1990). Even if contamination by food chains has generally been considered as being more important than the others (André *et al.*, 1990), it is difficult to determine the relative importance of each form of penetration because of the absence of experimental investigations.

ACKNOWLEDGEMENTS We thank all the people who have helped us in the collection and sampling of dolphins: the Fanny Observatory team (MM. Charreire, Nieri, Bellon Gravez, Jengou, Miss Dilasser, Jimenez, Pillore and Portal), Mrs. Duron and Mr. Millo of the Museum d'Histoire Naturelle de Marseille, MM. Bompar, Dhermain, Cheylan and Miss Poitevin of the Groupe d'Etude des Cétacés En Méditerranée (GECM), and Mr. Cara in charge of gamma-spectrometry determinations.

REFERENCES

- André, J. M., Ribeyre, F. and Boudou A. 1990. Mercury contamination levels and distribution in tissues and organs of Delphinids (*Stenella attenuata*) from the eastern tropical Pacific, in relation to biological and ecological factors. *Mar. Environ. Res.*, U.S.A., 30: 43-72.
- Augier, H. 1970. La lyophilisation, son utilisation en phycoécologie. *Bull. Mus. Hist. nat.*, Marseille, Fr., 30: 229-251.
- Augier, H., Park, W. K., Ramonda G. and Santimone, M. 1991. Menaces des polluants métalliques sur les dauphins de nos rivages. Colloque international des espèces marines à protéger en Méditerranée. 18-19 novembre 1989, Carry-Le-Rouet. G.I.S Posidonies Edit., Marseille, France: 317-338.
- Augier, H., Park, W. K. and Ronneau, C. 1993. Mercury contamination of the striped dolphin *Stenella coeruleoalba* Meyen from French Mediterranean coasts. *Mar. Pollut. Bull.*, G.B., 26: 306-310.
- Benzecri, J. P. 1980. *Pratique de l'analyse des données. Tome 2.* Dunod Edit. Paris, France. 456 pp.
- Benzecri, J. P. 1982. *L'analyse des données. Tome 1. Taxinomie.* Dunod Edit. Paris, France. 615 pp.
- Benzecri, J. P. 1983. *L'analyse des données. Tome 2. L'analyse des correspondances.* Dunod Edit. Paris, France. 619 pp.
- Bouroche, J. M. and Saporta, G. 1983. *L'analyse des données.* Presses Universitaires de France, Paris, France, 127 pp.
- Capeaa, P. and Van Curtsem, B. 1988. Méthodes et modèles en statistique non paramétrique. *Presses de l'Université, Laval et Dunod Edit.*, Paris, Fr: 358 p.
- Capelli, R., de Pellegrini, R., and Minganti, V. 1989. Preliminary results on the presence of inorganic mercury and selenium in dolphins (*Stenella coeruleoalba*) from the Ligurian Sea. Pp. 19-24. In *European research on cetaceans - 3.* (Eds. P.G.H. Evans, A. Aguilar & C. Smeenk). 3rd Ann. Conf. of ECS, La Rochelle, France, 24-26 Feb 1989. European Cetacean Society, Cambridge, England.
- Cibois, P. 1987. *L'analyse factorielle.* Presses Universitaires de France, Paris, France. 127 pp.
- Diday, E., Lemaire, J. and Testu, F. 1982. *Éléments d'analyse des données.* Dunod Edit. Paris, France. 462 pp.
- Foulquier, L. and Philippot, J. C. 1982. Métrologie de l'environnement, échantillonnage et préparation d'organismes d'eau douce. Mesure des radionucléides émetteurs gamma. Rapport Centre d'Etudes Atomiques, Cadarache, France, 5163: 1-53.
- Fowler, B. P. 1972. Ultrastructural evidence of nephropathy induced by long term exposure to small amounts of methyl mercury. *Science*, U.S.A., 175: 780-7.

- Gigon, F. 1975. *Le 400ème chat ou les pollués de Minamata*. Robert Laffont Edit., Paris, France. 232 pp.
- Honda, K., Tatsukawa, R., Itano, K., Miyazaki, N., and Fujiyama, T. 1983. Heavy metals concentrations in muscle, liver and kidney tissues of striped dolphin *Stenella coeruleoalba* and their variations with body length, weight, age and sex. *Agric. Biol. Chem., U.S.A.*, 47(6): 1219-28.
- Lefebvre, J. 1983. *Introduction aux analyses statistiques multidimensionnelles*. Masson Edit., Paris, France. 275 pp.
- Legendre, L. 1979. *Ecologie numérique. Tome 1. Le traitement multiple des données écologiques*. Masson Edit., Paris, France and Presses de l'Université du Québec, Canada. 184 pp.
- Legendre, L. and Legendre, P. 1979. *Ecologie numérique. Tome 2. La structure des données écologiques*. Masson Edit., Paris, Fr. et Presses de l'Université du Québec, Canada. 248 pp.
- Martoja, M. and Martoja, R. 1985. La bioaccumulation des métaux: processus physiologique normal et conséquence de la pollution. *Le Courrier du Centre Nat. de la Rech. Sci., France*, 54: 32-37.
- Martoja, R. and Viale, D. 1977. Accumulation de granules de séléniure mercurique dans le foie d'Odontocètes (Mammifères, Cétacés) ; un mécanisme possible de détoxication du méthyl-mercure par le sélénium. *C. R. de l'Acad. des Sci., Fr.*, 285: 109-112.
- Nordberg, E. 1976. *Effects and dose-response relationships of toxic metals*. Elsevier Scientific Publi. Compagny, Amsterdam, Holl: 281 pp.
- O.C.D.E. 1974. *Le mercure et l'environnement*. Organisation de Coopération et du Développement Economiques, Paris, France. 207 pp.
- O.M.S. 1979. *Critères d'hygiène de l'environnement 1 : Mercure*. Organisation Mondiale de la Santé, Genève, Suisse : 150 p.
- Pelletier, E. 1985. Mercury-selenium interactions in aquatic organisms: a review. *Mar. Environ. Res., U.S.A.*, 18: 11-32.
- Singhal, R., Kowc, I. and Sutherland, J. 1974. Metabolic alterations in liver and kidney following chronic methyl-mercury treatment and with drowal. *Environ. Res., U.S.A.*, 7(2): 220-299.
- Thibaud, Y. 1978. Présence simultanée de mercure et de sélénium chez le dauphin et le thon rouge. IVe Journées Etudes Pollutions Comm. Intern. Et. Sci. Mer Médit., Antalya: 193-196.
- Viale, D. 1974. Divers aspects de la pollution par les métaux chez quelques Cétacés de Méditerranée occidentale. *Compte Rendu Travaux Comité Lutte contre Pollution Marine, Comm. Intern. Et. Sci. Médit., Monaco, décembre 1974*: 183-192.
- Viale, D. 1978. Evidence of metal pollution in Cetacea of the western Mediterranean. *Ann. Inst. Océan., France*, 54, 1: 5-16.

Table 1 Main characteristics of striped dolphin *Stenella coeruleoalba*.

Code	Date	Site	Sex	W./L.	C.S.	Collector
1	29/12/88	BdR	F	68/170	Sardine Squid	Charreire
2	11/01/89	BdR	M	77/175	Sardine	Charreire
3	29/11/89	BdR	M	95/191	Squid	Charreire
4	nc 90	BdR	nc	nc		M.H.N.M.
5	nc 90	BdR	nc	nc		M.H.N.M.
6	01/10/90	BdR	M	91/203	Squid	M.H.N.M.
7	30/09/90	BdR	M	79/195	Squid	M.H.N.M.
8	22/09/90	BdR	F	nc/197	Squid	M.H.N.M.
9	01/11/90	BdR	F	100/200	-	Dhermain
10	26/10/90	Var	F	87/203	-	Bompar
11	18/10/90	Var	M	75/185	-	Bompar
12	24/09/90	Var	M	83/206	-	Bompar
13	11/10/90	Var	F	68/183	-	Bompar

W. = Weight (kg), L. = Length (cm), C.S. = Contents of Stomach, BdR = Bouches du Rhône, M.H.N.M = Museum d'Histoire Naturelle de Marseille, nc = not communicated

Table 2 Mann-Whitney tests of Hg/Se ratio between skin samples and other samples of *Stenella coeruleoalba*.

Skin	Blubber	Brain	Heart	Kidney	Liver	Lung	Melon	Muscle
	<<	<<	<<	<<	<<	<<	<<	<<

<< = Significant at $p < 0.05$

Table 3 Metal correlations between metals in organs and tissues of *Stenella coeruleoalba*

	Bl	Br	He	Ki	Li	Lu	Me	Mu	Sk
As + Br :	0	0	0	0	+1	0	0	0	0
As + Na :	0	0	0	0	0	0	0	0	0
As + K :	-1	0	0	-1	0	0	0	0	0
As + Se :	0	0	-1	-1	0	0	0	0	0
As + Hg :	0	0	2	-2	0	0	0	-1	+2
As + Co :	0	0	0	-2	0	0	0	0	-1
As + Rb :	0	*	0	-2	0	0	0	0	0
As + Zn :	0	0	0	-1	0	0	0	0	+1
As + Cs :	*	0	*	0	0	0	*	0	+1
Br + Na :	+1	+3	+3	+3	+1	+3	+3	+3	+3
Br + K :	0	0	0	0	0	0	+3	0	0
Br + Se :	+1	0	0	0	-1	0	+3	0	0
Br + Hg :	0	0	0	0	-1	0	+2	0	0
Br + Co :	0	0	0	0	0	0	0	0	0
Br + Rb :	0	+2	0	+1	0	0	0	0	0
Br + Zn :	0	+1	0	0	0	0	+3	0	0
Br + Cs :	*	0	*	+1	0	0	*	0	0
Na + K :	+2	0	0	+3	0	0	+3	0	0
Na + Se :	+1	0	0	0	-3	0	+3	0	+1
Na + Hg :	+1	0	0	0	-3	0	+3	0	0
Na + Co :	+1	0	0	0	0	0	0	+1	0
Na + Rb :	0	0	0	+1	0	0	0	0	0
Na + Zn :	+2	+1	0	0	0	0	+3	0	0
Na + Cs :	*	+1	*	0	0	0	*	0	0
K + Se :	+1	0	0	0	0	-1	+3	0	+2
K + Hg :	+1	0	0	0	0	-1	+3	0	0
K + Co :	0	0	0	+1	+1	0	0	0	0
K + Rb :	0	0	0	+2	0	0	0	+1	+2
K + Zn :	+1	0	0	0	+1	0	+3	0	+3
K + Cs :	*	0	*	0	0	0	*	0	0
Se + Hg :	+2	+3	+2	+3	+3	+3	+3	+3	0
Se + Co :	0	0	0	+1	0	0	0	0	0
Se + Rb :	+2	0	0	0	0	0	0	0	+2
Se + Zn :	+1	0	0	+2	0	0	0	0	+3
Se + Cs :	*	0	*	0	0	0	*	0	0
Hg + Co :	0	0	+1	+1	0	0	0	0	0
Hg + Rb :	+1	0	0	0	0	0	0	0	0
Hg + Zn :	0	0	0	+2	0	0	+3	0	+1
Hg + Cs :	*	0	*	0	0	0	*	0	0
Co + Rb :	0	0	+1	+2	0	0	0	0	0
Co + Zn :	0	0	0	+1	0	0	0	0	0
Co + Cs :	*	0	*	0	0	0	*	0	-1
Rb + Zn :	0	0	0	+1	0	0	0	0	+2
Rb + Cs :	*	0	*	0	0	0	*	0	0
Zn + Cs :	*	+3	*	0	0	0	*	0	0

- and + = directions of correlation, *=non-test, 0=not significant at $p < 0.05$, 1,2,3 = significant respectively at $0.05 > p > 0.01$, $0.01 > p > 0.001$ and $p < 0.001$
 BL=Blubber, Br=Brain, He=Heart, Ki=Kidney, Li=Liver, Lu=Lung,
 Me=Melon, Mu=Muscle, Sk=Skin.

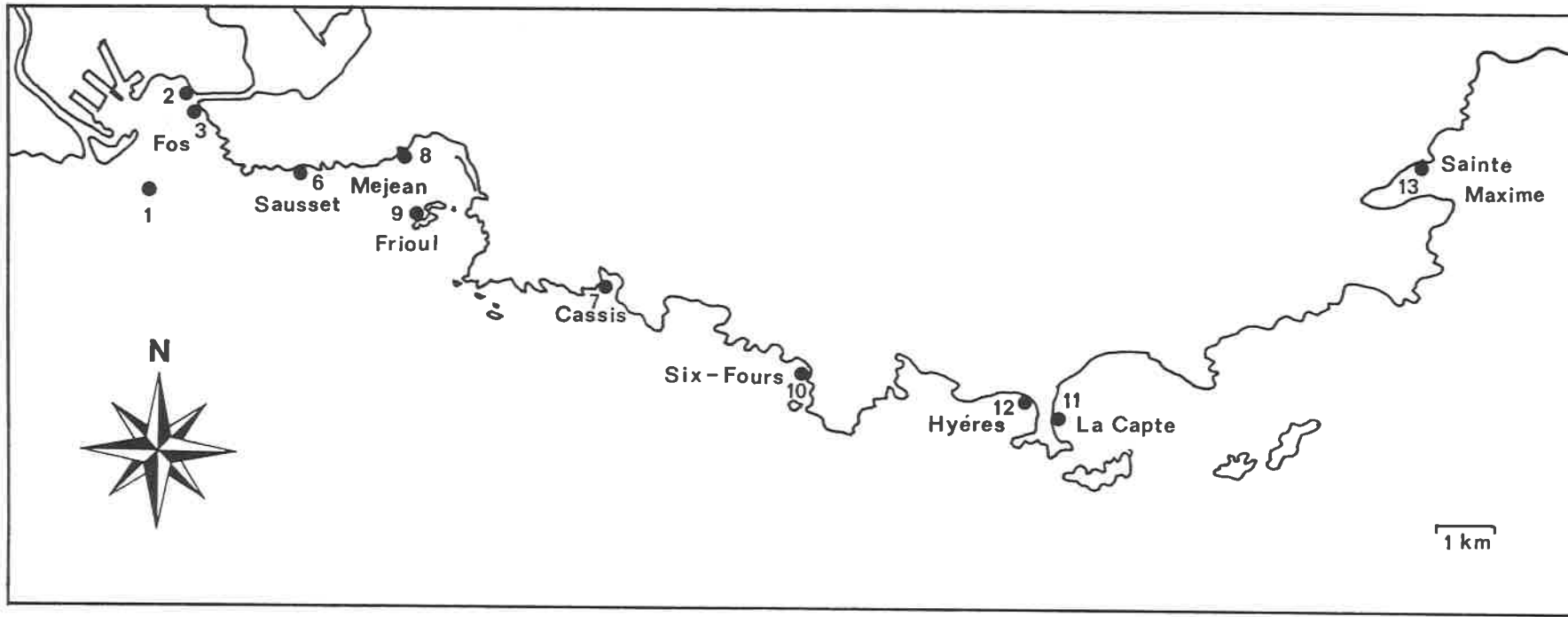

Fig. 1 Location of sampling areas of dolphins *Stenella coeruleoalba* along the French Mediterranean coast (we do not have locations for sites 4 and 5 whilst No. 1 was collected by boat).

THE ALGAL INVESTIGATIONS FOR WATER POLLUTION DETERMINATION IN MARINE MAMMAL CAPTURE SITES

Evgeny B. Gol'din

BREMA Laboratory, 333720, Simferopol, Crimea, Ukraine

INTRODUCTION The algae are a very significant environmental component of a variety of aquatic ecosystems, and play an important role in the sanitary valuation of covered or open-air pools, tanks and reservoirs. There are clear differences between algal vegetation in an environment affected by human activities. It is known that water enrichment with simple forms of nitrogen, phosphorus and carbon leads to algal growth and reproduction, and changes in species composition leading to eutrophication (Hutchinson, 1969). Water pollution can not only suppress algal growth, but also stimulate it (for example marine benthic species) in a different sea area. Their comparative analyses make it impossible to determine some species of algae, the pollution presence and its level indicated (South and Whittick, 1987). The quest for such microphytic algae and their practical application in dolphinarium is one of our scientific objectives.

MATERIALS AND METHODS During recent investigations in the Karadag dolphinarium and bordering Black Sea coasts (Eastern Crimea), about 400 algal samples were collected. This material included planktonic, benthic and bottlenose dolphin *Tursiops truncatus* skin scraped specimens. All samples were fixed with 70% ethanol or weak formalin solution, or placed in the Gol'dberg media, then identified. The resulting data were analysed in accordance with the existing systems for biological indicators of contaminated waters and the list of algal indicators of water pollution levels (Vodorosli, 1989).

RESULTS AND DISCUSSION The algal material contained 57 species, intra-specific taxa and their associations, related to four systematic groups (Bacillariophyta, Dinophyta, Cyanophyta and Chlorophyta), but pennate diatoms were dominated as the most widely founded forms of marine algae. This situation predominates throughout the year: in temperate coastal waters, the diatoms always prevails over all other forms of algae, but the size of the dinoflagellates population increases in summer.

The comparative analysis of aquatic pools and aquatic concentrations of algae bordering the sea had a number of interesting features:

- (1) The algal vegetation of the dolphinarium was as rich as the littoral zone with a variety of forms.
- (2) On the other hand, algal concentrations forming in a dolphinarium have their own peculiarities. Several factors within the pool play a definite role - temperature, chlorination, organic enrichment, and a correlation between growth at the surface and water volume. The algal vegetation distinctions, occurring between different ecological groups, are shown in Table 1.
- (3) Stable algal associations from resistant species (mainly diatom concentrations) in the dolphinarium pools. For example, some benthic diatoms (*Achantes longpipes* and others), due to their composition, structure and metabolism features, are very resistant to the negative influence of the environment. They have an exceptional ability for the detoxification of copper (Kucherova, 1969).
- (4) Amongst algal blooms in dolphinarium, a number of pollution indicator species were presented: *Oscillatoria* sp., *Prorocentrum cordata* (indicates organic pollution), *Bacillaria*

paradoxa (indicating high chloride content). These findings support the case for prompt measures to improve pool conditions.

(5) The algal vegetation on the skin surface of dolphins differed markedly between captive and free-living animals. Skin algae are present on almost all the captured dolphins, whereas wild animals are virtually free from skin surface algae.

CONCLUSIONS The distinctions between the algal vegetation of different ecological zones dependant upon anthropogenic influences show that the chosen method is very suitable for future investigations of dolphinaria using microalgae as bio-indicators of water pollution.

ACKNOWLEDGEMENTS We sincerely thank the BREMA Laboratory for help with this study.

REFERENCES

- Odum, E. P. 1971. *Fundamentals of Ecology*. Philadelphia, London and Toronto. 740 pp.
 Veb Gustav Fischer Verlag. 1985. *Bioindikation in terrestrischen Okosystemen*. Jena. 350 pp.
 Hutchinson, L. E. 1969. Eutrophication past and present. Pp. 17-26 in *Eutrophication: Causes, Consequences, Correctives*. Academy of Sciences, Washington D. C.
 South, G. R. and Whittick, A. 1987. *Introduction to Phycology*. Blackwell Scientific Publications. 597 pp.
 Vodorosli. 1989. *The reference book*. Naukova dumka, Kiev. 608 pp.
 Kucherova, Z. S. 1969. The influence of copper on the development of diatom blooms. Pp. 143-147. In *Biological investigations of the Black Sea and its resources*. Nauka, Moscow.

Table 1 The distribution of the main species of diatom algae

The Algae genus	Plankton	Pool walls overgrow-ings	Dolphins skin surface scra-pings
Achnantes	3	2	2
Amphora	3	4	2
Grammatophora	1	2	1
Licmophora	3	5	3
Melosira	1	2	1
Navicula	3	4	4
Nitzschia	5	7	4
Pleurosigma	3	2	1
Striatella	1	2	1
Synedra	-	1	1

ACTION PLAN FOR RESCUE, REHABILITATION AND REINTRODUCTION OF WILD SICK AND TRAUMATISED BLACK SEA CETACEANS

A. Birkun, Jr.*, A. Stanenis** and M. Tomakhin***

*BREMA Laboratory, Simferopol, Crimea 333720, Ukraine

**Laspi Dolphinarium, Sevastopol, Crimea 335001, Ukraine

***Ministry of Environmental Protection of Ukraine, Kiev 252001, Ukraine

INTRODUCTION An action plan for the rescue, rehabilitation and reintroduction of wild sick and traumatised cetaceans (RRR-plan) is a constituent part of the Ukrainian National Programme for the conservation of Black Sea dolphin populations. This plan prepared by BREMA Laboratory and Laspi Dolphinarium was ratified by the Ministry of Environmental Protection of Ukraine on 6 October, 1993. Numerous cases of human-associated damage to marine mammals are the grounds for the establishment of the RRR-plan.

AIMS AND METHODS

- 1) Rapid passive collection of all possible information on suffering animals (network of informants including state fisheries control service, regional environment protection committees, frontier guards, local non-governmental nature protection organisations and amateur groups).
- 2) Active search for suffering animals (regular patrol observations at fishing areas and other places with a heightened risk for cetaceans).
- 3) Criteria for rescue and rehabilitation activities (list of animal conditions where urgent human help or stationary support are desirable).
- 4) Rescue service (mobile detachment(s) equipped for dolphin search, individual capture, immediate technical and veterinary assistance and animal transportation).
- 5) Rescue and rehabilitation techniques adapted for bottlenose dolphins, common dolphins and harbour porpoises (medical care and maintenance of stranded, by-caught, sick and traumatised animals).
- 6) Marine mammal rehabilitation centre (re-organisation and reconstruction of existing facilities in Laspi Dolphinarium, South Crimea).
- 7) Dolphin reacclimatising and releasing techniques.
- 8) Technical systems and methods for monitoring released animals in nature.

PRELIMINARY RESULTS (Crimea, January - February 1994) One harbour porpoise was rescued from a poaching dogfish gillnet in Laspi Bay. The animal was released after disentanglement and an antibiotic injection.

As a result of an active search at the South Crimea fishing area, six dead harbour porpoises were registered in one bottom fixed plaice net. Stranded carcasses were found in Laspi Bay (one harbour porpoise) and on the Tarhankut peninsular coast (two bottlenose dolphins).

ACKNOWLEDGEMENTS The RRR-plan is being carried forward with a grant from the Ministry of Environmental Protection of Ukraine and with the financial support of Marineland-Antibes. We particularly wish to thank Jon Kershaw (Marineland-Antibes) and Andrew Greenwood (International Zoo Veterinary Group) for all their help and consultations.

SOME CHANGES IN THE HELMINTH FAUNA OF BLACK SEA DOLPHINS

Sergei Krivokhizhin and Alexei Birkun, Jr.

BREMA Laboratory, Simferopol, Crimea 333720, Ukraine

INTRODUCTION The first information on Black Sea dolphin helminths was published in 1935 by L. Borcea. She noted two cestode species in the bowels of harbour porpoise (*Diphylobothrium stemmacephalum*, *D. latum*) and common dolphin (*D. stemmacephalum*) and one nematode species (*Anisakis simplex*) in the gastrointestinal tract of harbour porpoise. Since then, nobody has observed *D. latum* and *A. simplex* in Black Sea cetaceans.

The most important findings were made between 1945 and 1966 during the industrial mass dolphin killing, when ten more Black Sea dolphin parasites were described: trematodes *Campula palliata* (common dolphin), *Synthesium tursionis*, *Braunina cordiformis* (bottlenose dolphin), *Pholeter gastrophylus* (harbour porpoise) and nematodes *Halocercus kleinenbergi*, *Skrjabinalius cryptocephalus* (common dolphin), *Stenurus ovatus* (bottlenose dolphin), *H. taurica*, *H. ponticus*, *S. minor* (harbour porpoise) (Delamure, 1955, 1971; Delamure *et al.*, 1963; Delamure and Serdyukov, 1966; Greze *et al.*, 1975). Moreover cestode *D. stemmacephalum* was found in bottlenose dolphin (Delamure, 1971).

Thus, thirteen species of Black Sea dolphin helminths were known up to the start of our investigation.

MATERIALS AND METHODS During the period February 1989 to February 1994, 414 stranded dolphins were found on the coast of Crimea: 104 animals (six bottlenose dolphins, 22 common dolphins, and 76 harbour porpoises) were examined by means of traditional helminthological and pathomorphological techniques.

RESULTS Parasitic worms of five previously described species were isolated from dead dolphins. *P. gastrophylus* was not only in harbour porpoises, but in bottlenose and common dolphin stomachs also. Four other well known helminths were observed in intestines (*D. stemmacephalum*), lungs (*H. taurica*, *H. ponticus*), the internal ear and cranial sinuses (*S. minor*) of harbour porpoises.

At the same time, we have never seen *C. palliata*, *D. stemmacephalum*, *H. kleinenbergi* and *S. cryptocephalus* in common dolphins, *S. tursionis*, *B. cordiformis*, *D. stemmacephalum* and *S. ovatus* in bottlenose dolphins, and *D. latum* and *A. simplex* in harbour porpoises.

Nematodes *Crassicauda* sp. not recorded between the 1940s and 1960s were revealed in the cranial air sinuses of all three Black Sea cetacean species. The maximum prevalence (100%) of harbour porpoises *Halocercus* spp. and *S. minor* invasions (Fig. 1) was in full accordance with similar data from previous years (Delamure, 1956).

CONCLUSION It is very possible that significant changes in the Black Sea cetacean helminths fauna have occurred during the last 2-3 decades: some worms have probably been lost, some become predominant, and a nematode *Crassicauda* sp. - a new parasite - has spread to all Black Sea dolphin species. Apparently these changes are the components of a more global process connected with regional environmental problems.

REFERENCES

Borcea, L. 1935. Sur la presence du cestode *Diphyllobothrium stemmacephalum* Cobbold comme parasite chez le marsouin, *Phocoena phocoena* de la Mer Noir. Ann. Sci. Univ. Jassi., 21: 524-525.

Delamure, S. L. 1955. *Helminths fauna of marine mammals in connection with their ecology and phylogeny*. Publ. House USSR Acad. Science, Moscow. 517 pp.

Delamure, S. L. 1971. *Diphyllobothrium ponticum* n. sp. - parasite of Black Sea bottlenose dolphin. Proc. Allunion Helminthol. Soc. Conf., Moscow.

Delamure, S. L., Skryabin, A. S. and Alexeyev, Ye. V. 1963. The first finding of *Braunina cordiformis* Wolf in bottlenose dolphin of the Black Sea. Pp. 104-106. In *Helminths of Man, Animals and Plants and the struggle against them*. Publ. House USSR Acad. Science, Moscow.

Delamure, S. L. and Serdyukov, A. M. 1966. Trematode *Synthesium tursionis* (Marchi, 1872) discovery in bottlenose dolphin of the Black Sea. Proc. Scientific Session Allunion Helminthol. Soc., 3: 104-106.

Greze, V. N., Delamure, S. L. and Nikolayeva, V. M. (eds.). 1975. *Manual for Black Sea of Azov vertebrates parasites determination*. Naukova Dumka, Kiev. 522 pp.

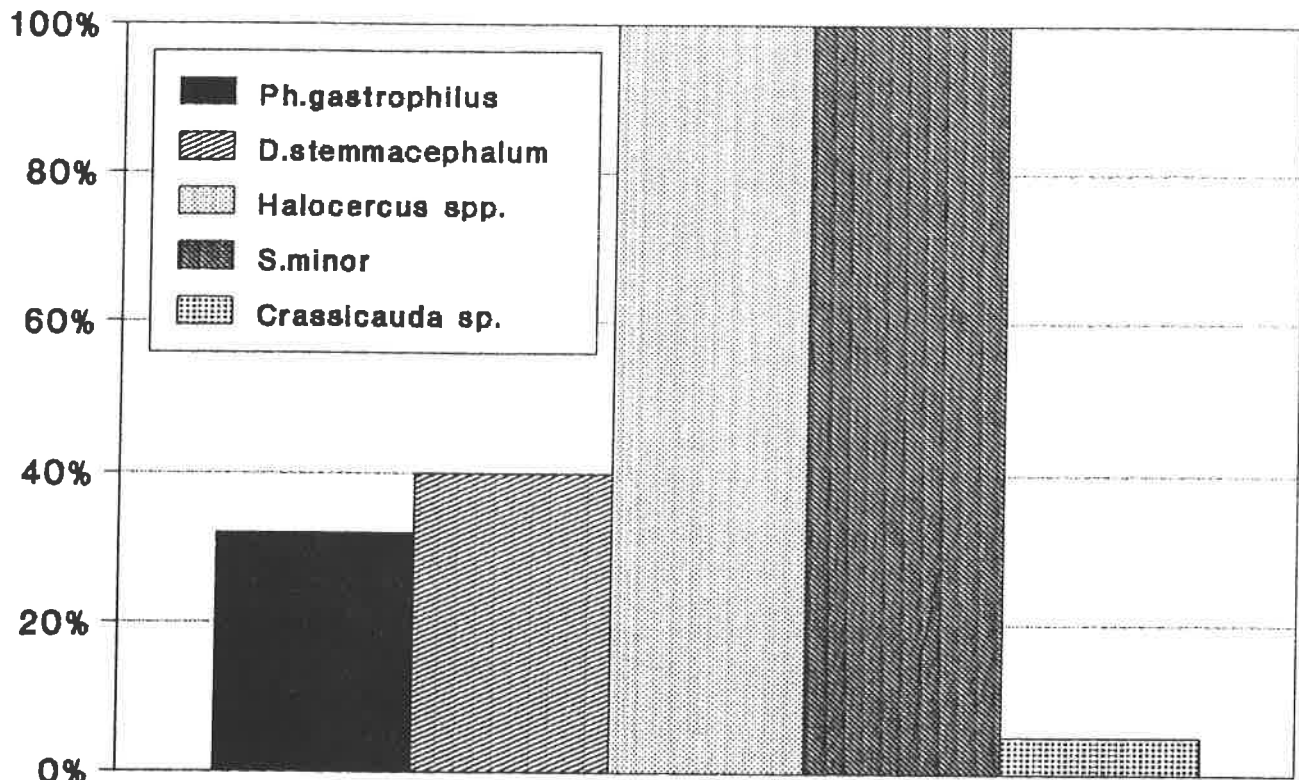

Fig. 1 Prevalence of Black Sea harbour porpoise helminth invasions

INTESTINAL HELMINTHS AS BIOLOGICAL INDICATORS OF LONG-FINNED PILOT WHALES OFF THE FAROE ISLANDS

J. A. Balbuena, J. A. Raga, F. J. Aznar and M. Fernández

Department of Animal Biology, University of Valencia,
46100 Burjassot, Valencia, Spain.

INTRODUCTION Various studies have employed parasite data to obtain information on the biology of cetacean species (Balbuena and Raga, 1991; Dailey and Vogelbein, 1991; Walker, 1990). However, due to methodological reasons, these techniques are difficult to apply to these animals. The purpose of this study is to illustrate the usefulness and limitations of this approach. We focus here on two important biological aspects of the long-finned pilot whale (*Globicephala melas*:) their population identity and the social structure of the pods.

MATERIALS AND METHODS We studied 101 pilot whales, belonging to seven pods, caught in the traditional Faroese drive fishery (Table 1). The comparison across pods was based on four helminth species, occurring regularly in the host sample (prevalence $\geq 10\%$). The statistical methods used are described elsewhere (Balbuena and Raga, 1994).

Genetic studies suggest that sexually males avoid inbreeding by moving between pods, or remain but do not mate in their home pods (Amos *et al.*, 1993). To determine whether this behaviour had any effect on the helminth faunas of the pods, we carried out two resampling experiments concerning mature males (Balbuena and Raga, 1994).

RESULTS The seven pods differed significantly in overall abundances of helminth species. However, they could not be distinctly separated by a canonical analysis when all animals were considered: only 43.6% of the whales were correctly classified in their pods. A similar ordination of the pods was observed when mature males (those 12+ yrs old - Desportes, 1990) were omitted. However, a cluster analysis of the centroids based on Mahalanobis' distances suggests that pods 1, 2 and 3 are closer to each other than a more heterogeneous group formed by the remainder (Fig. 1). Considering these two groups, 89% of animals from pods 1-3 and 86% from pods 4-7 were correctly classified. We observed a similar overall pattern of separation between two groups when adult males were excluded (Fig. 1): 89.1% of animals from pods 1-3 and 88.2% from 4-7 were correctly allocated to either of the groups.

Apparently, the exclusion of adult males in the analyses had little effect on the patterns observed. On the other hand, this may be because they were not numerically important in the sample. The resampling experiments showed that (i) adult males were more difficult to allocate to their particular pods than the remainder; and (ii) their exclusion in the canonical analysis improved the classification results significantly.

DISCUSSION The differences between pods 1-3 and 4-7 seem congruent with previous genetic and pollutant studies (Aguilar *et al.*, 1993; Andersen, 1993; Caurant *et al.*, 1993), supporting the hypothesis that there might be a certain degree of segregation, either geographical, seasonal or behavioural, between pods of Faroese pilot whales. Although pods may feed on different grounds, this evidence does not seem conclusive enough to confirm the presence of separate stocks or populations of pilot whales.

The comparison between adult males and the remaining individuals in parasite infections strongly suggests different food habits. Either sexually mature males differed in feeding behaviour within the pods or they foraged in different areas than the rest of the individuals from their pods. To our knowledge, there is no evidence available supporting the first hypothesis, while the second agrees with previous genetic studies suggesting that adult

males avoid inbreeding by moving between pods (Amos *et al.*, 1993). Most (12 of 18) of the sexually mature males belonged to pods taken in the summer (Table 1), coinciding with the peak of male sexual activity in the Faroes (Desportes, 1990). This is consistent with either of the two mating systems proposed for the long-finned pilot whale (Amos *et al.*, 1993).

This work was supported by a DGICYT grant (Project No. PB87-997).

REFERENCES

- Aguilar, A., Jover, L., and Borrell, A. 1993. Heterogeneities in organochlorine profile of Faroese long-finned pilot whales: indication of segregation between pods? Rep. Int. Whal. Commn (Special Issue 14): 359-367.
- Amos, B., Schlötterer, C., and Tautz, D. 1993. Social structure of pilot whales revealed by analytical DNA profiling. *Science*, 260: 670-672.
- Andersen, L. W. 1993. Further studies on the population structure of the long-finned pilot whale, *Globicephala melas*, off the Faroe Islands. Rep. Int. Whal. Commn (Special Issue 14): 219-231.
- Balbuena, J. A., and Raga, J. A. 1991. Ecology and host relationships of the whale-lice *Isocyamus delphini* (Amphipoda: Cyamidae) parasitizing long-finned pilot whales (*Globicephala melas*) off the Faroe Islands (N.E. Atlantic). *Can. J. Zool.*, 69: 141-145.
- Balbuena, J. A., and Raga, J. A. 1994. Intestinal helminths as indicators of segregation and social structure of pods of long-finned pilot whales (*Globicephala melas*) off the Faeroe Islands. *Can. J. Zool.*, 72: in press.
- Caurant, F., Amiard-Triquet, C., and Amiard, J. C. 1993. Factors influencing the accumulation of metals in pilot whales (*Globicephala melas*) off the Faroe Islands. Rep. Int. Whal. Commn (Special Issue 14): 219-231.
- Dailey, M. D., and Vogelbein, W. K. 1991. Parasite fauna of three species of Antarctic whales with reference to their use as potential stock indicators. *Fish. Bull. U.S.*, 89: 355-65.
- Desportes, G. 1990. Pilot whale research in the Faroe Islands - presentation and preliminary results. Pp. 47-54. In *North Atlantic Studies. Vol. 2 - Whaling Communities*. (Editor E. Vestergaard). Aarhus University Press, Aarhus, Denmark.
- Walker, W. A. 1990. Geographic variation of the parasites *Crassicauda* (Nematoda) and *Phyllobothrium* (Cestoda) in *Phocoenoides dalli* in the northern North Pacific, Bering and Okhotsk Sea. Document SC/42/SM16 presented to the 42nd Scientific Committee of the IWC, Noordwijk, The Netherlands, 2-6 July 1990, 15 pp.

Table 1 Data concerning 101 long-finned pilot whales from seven pods used for comparison of helminth abundances

Pod No.	Locality	Date	Age (yrs)		♂♂ ^a	♀♀	N
			$\bar{X} \pm SD$				
1	Leynar	22 Jul. 1987	10.7 ± 8.8		3(1)	12	15
2	Miðvágur	24 Jul. 1987	17.8 ± 11.4		4(0)	5	9
3	Miðvágur	2 Aug. 1987	14.5 ± 9.7		6(4)	7	13
4	Vágur	18 Sep. 1987	10.8 ± 9.1		4(1)	8	12
5	Tórshavn	8 Oct. 1987	10.6 ± 10.7		9(3)	9	18
6	Vágur	20 Oct. 1987	13.8 ± 12.3		5(2)	10	15
7	Leynar	10 Jun. 1988	10.5 ± 8.6		9(7)	10	19
Totals for whole sample			12.2 ± 10.0		40(18)	61	101

^a Numbers in parentheses correspond to mature males (see materials and methods section).

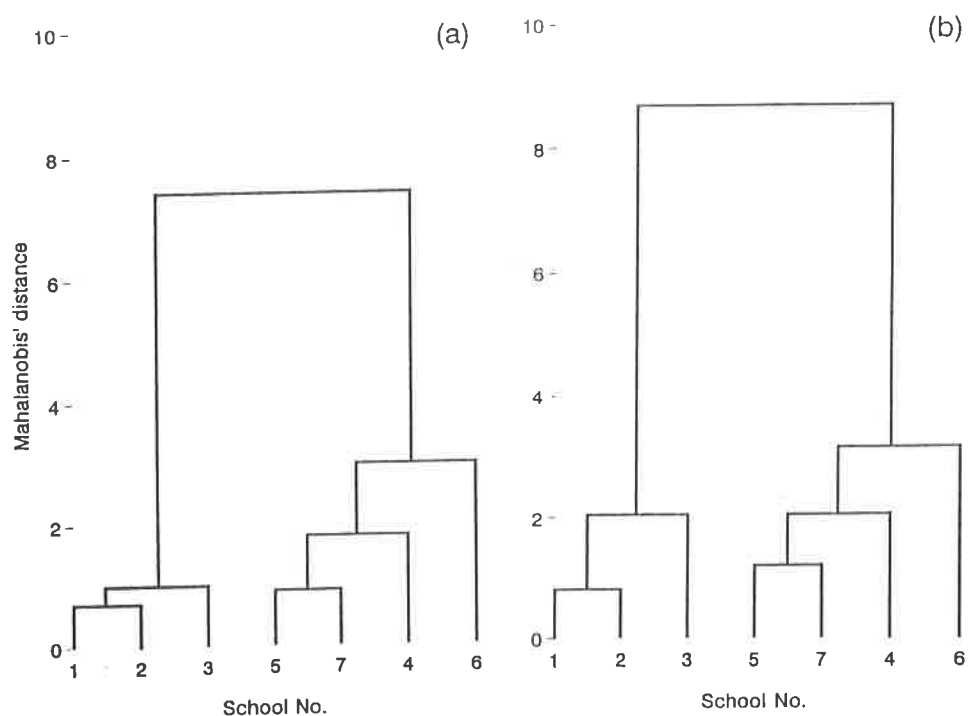

Figure 1 Cluster based on Mahalanobis' distances between seven pods of pilot whales (numbered as in Table 1), including all animals (a) and excluding mature males (b)

ON THE IDENTITY AND EMIGRATION OF *SCOLEX PLEURONECTIS* LARVAE (CESTODA) IN THE STRIPED DOLPHIN

F. J. Aznar, J. A. Balbuena and J. A. Raga

Department of Animal Biology, University of Valencia,
Dr. Moliner 50,46100 Burjasot, Valencia, Spain

INTRODUCTION Tetrphyllidean larval cestodes (plerocercoids) occur in almost all cetaceans. Morphologically, three forms can be distinguished: *Phyllobothrium delphini*, *Monorygma grimaldii* and *Scolex pleuronectis*, whose taxonomic status and location in cetaceans are shown in Table 1. Although the existence of these plerocercoids is known from pre-Linnean times, today there are still many unanswered questions left: (i) What and how many species do they represent? (ii) What is the role of cetaceans in their life cycle? (iii) How can *S. pleuronectis* reach the blubber and mesenteries and so become immobile larvae? So far, there are no clear answers to the first question; current hypotheses for (ii) and (iii) are summarised in Figs 1 and 2.

All these larval forms occur in striped dolphins (*Stenella coeruleoalba*) from the Western Mediterranean (Raga *et al.*, 1990). We show here new data on the identity of *S. pleuronectis*, discussing its relationship with *M. grimaldii* and *P. delphini*.

MATERIALS AND METHODS Intestines of 19 striped dolphins were cut in 20 equal sections. The wall of each section was carefully examined under a stereo microscope for potential burrowing of *S. pleuronectis*. Serial sections of areas with positive results were stained with Masson Trichromic. Groups of ten *S. pleuronectis* specimens, from the rectum and anus, were chosen in five hosts at random and measured under a stereo microscope at 50x magnification for differences in size.

RESULTS Two types of *S. pleuronectis* were found (Table 2). We termed these morphotypes 'large' and 'small'. Both occurred in all dolphins. Few specimens of either morphotype were found free in the intestine. Most (often several hundreds) burrowed in very specific, separate sites: 'Large' did so in the anus, and 'small' in the rectum. Large plerocercoids did not seem to burrow deeper than the intestinal submucosa, while small ones were restricted to the mucosa.

DISCUSSION The occurrence of several *S. pleuronectis* morphotypes is well documented in cetaceans (Skrjabin, 1972). Our morphotypes seem to conform with some of the specimens described by Skrjabin (1972) in the sperm whale. This author considered the morphotypes as developmental stages of the same plerocercoid species. However, Skrjabin's emigration model (Fig. 2) did not consider different sites of burrowing for each hypothetical developmental stage as observed here. The spatial segregation between morphotypes could be considered more parsimonious with the existence of two groups of *S. pleuronectis* species. Establishing an unambiguous relationship between each *S. pleuronectis* morphotype, and *Monorygma* and *Phyllobothrium*, although tempting, is premature. Certainly, all these larval groups showed similar high prevalences (see Raga *et al.*, 1991), and the site of burrowing of these two *S. pleuronectis* morphotypes might be the shortest way to reach the ano-genital area of the dolphin, where most *Monorygma-Phyllobothrium* larvae usually appear. However, we have no clear evidence of *S. pleuronectis* entering blood or lymphatic vessels. In addition, *S. pleuronectis* might not be tetrphyllidean larvae, but plerocercoids of the family Tetrabothriidae which become adult in striped dolphins (for example *Tetrabothrius forsteri*, *Strobilocephalus triangularis*).

ACKNOWLEDGEMENTS This work has been supported by CICYT projects NAT90-1254E and NAT91-1128-C4-1.

REFERENCES

- Baer, J. G. 1932. Contribution à l'étude des Cestodes des Cétacés. *Rev. Suisse Zool.*, 39: 195-229.
- Dailey, M. D. 1985. Diseases of Mammalia: Cetacea. Pp. 805-847. In *Diseases of Marine Animals*. Volume IV, Part 2 (Ed. O. Kinne). Biologische Anstalt Helgoland, Hamburg. 355 pp.
- Dollfus, R. P. 1964. À propos de la récolte, à Banyuls d'un cystique de Cestode chez *Tursiops truncatus* (Montagu, 1821). Les cystes de Cestodes chez les Cétacés et Pinnipèdes. *Vie Milieu, Suppl.* 17: 177-204.
- Raga, J. A., Aznar, J., Balbuena, J. A. and Fernández, M. 1991. Parasites and Epizoots in Striped Dolphins examined during the Western Mediterranean. *Proc. Mediterranean Striped Dolphin Mortality Intern. Workshop, Palma de Mallorca, 4-5 November, 39-46.* 192 pp.
- Skrjabin, A. S. 1972. Larvae of cestodes of the genus *Phyllobothrium* Van Beneden, 1850 (Tetraphyllidea), parasites of whales and other marine animals. *Parazitol. (Leningr.)*, 6: 426-434.
- Testa, J. and Dailey, M. D. 1977. Five new morphotypes of *Phyllobothrium delphini* (Cestoda: Tetraphyllidea), their relationship to existing morphotypes, and their zoogeography. *Bull. South. Calif. Acad. Sci.*, 76: 99-110.
- Williams, H. H. 1968. The taxonomy, ecology and host specificity of some Phyllobothriidae (Cestoda: Tetraphyllidea). *Phil. Trans. Roy. Soc. Lond.*, 253: 231-307.

Table 1 Taxonomic status and location of tetraphyllidean larvae in cetaceans (after Williams, 1968, Skrjabin, 1972, Testa & Dailey, 1977; Dailey, 1985; Raga *et al.*, 1991).

PLEROCERCOID GROUP	TAXONOMIC STATUS	LOCATION
<i>Phyllobothrium delphini</i>	Probably multispecific	Immobile larva found in blubber (usually in anogenital area, sometimes in other sites)
<i>Monorygma grimaldii</i>	Probably multispecific	Immobile larva found in the mesenteries of the abdomen (usually around the genital area)
<i>Scolex pleuronectis</i>	Earlier stage of <i>Phyllobothrium</i> and <i>Monorygma</i> ?	Mobile larva found in bile ducts, stomach, intestine

Table 2 Morphological differences between morphotypes of *S. pleuronectis* found in striped dolphins

SIZE:	MORPHOTYPE	
	Small	Large
X ± S.D. (mm)	0.53 ± 0.13	2.46 ± 0.38
Range	0.26-0.99	1.83-3.29
Intrinsic variability ¹	X ² = 17.58, p< 0.01	X ² = 8.99, p= 0.06
MORPHOLOGICAL CHARACTERS:		
Loculated bothridia	Yes (biloculated)	No
Accessory suckers	No	Yes

¹ Kruskal-Wallis test

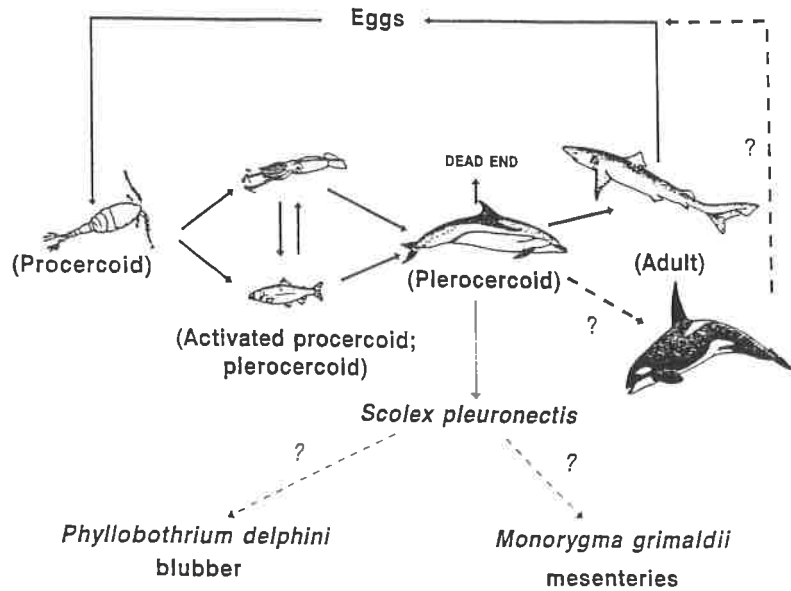

Fig. 1 Hypothetical life cycle of *Phyllobothrium delphini* and *Monorygma grimaldii* (after Baer 1932, Dollfus 1964, Williams 1968, Skrjabin 1972, Testa and Dailey 1977, Dailey 1985).

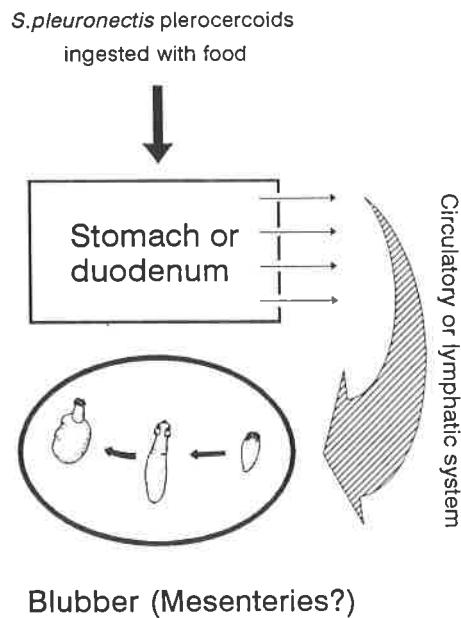

Fig. 2 Emigration pathway of *Scolex pleuronectis* within the cetacean body to become *Phyllobothrium delphini* (also valid for *Monorygma grimaldii*?) (after Skrjabin 1972).

FINDING OF LUNGWORMS (NEMATODA: PSEUDALIIDAE) IN A CALF OF HARBOUR PORPOISE *PHOCOENA PHOCOENA* IN BRITISH WATERS

V. Herreras*, M. Fernández*, C. Lockyer** and J.A. Raga*

*Departamento de Biología Animal. Universidad de Valencia,
Dr. Moliner 50, 46100 Burjasot, Valencia, Spain

**Sea Mammal Research Unit, c/o British Antarctic Survey,
High Cross, Madingley Road, Cambridge, CB3 0ET, UK

Several authors support the hypothesis of direct transplacental or transmammary infection of lungworm in cetaceans (Wesenberg-Lund, 1947; Woodward *et al.*, 1969). At least two cases have been reported to date (Woodward, 1969; Dailey *et al.*, 1991).

During a parasitological survey (between 1989-93) of 83 harbour porpoises (*Phocoena phocoena*) from the British coasts, we detected two lungworms (*Metastrongyloidea*) in a male porpoise 75 cm long and 8 kg in weight. The animal had a recently healed umbilicus indicating that it must be a newborn. This might indicate a direct transmission mother-calf, being supported by the absence of solid contents in the intestine, where only milk was found. This is the first record of vertical transmission of lungworms in the harbour porpoise.

Although little is known of the strategies of infection of lungworms in cetaceans, Dailey *et al.* (1991) considered that this mode of transmission might be more common than previously suspected. Only one calf, of 18 analysed, harboured lungworms. However, 85.2% of 27 females were infected by lungworms. Since a part of these animals was by-caught, a direct transmission from mother to calf could be feasible in nature, but it actually seems to be uncommon.

This work was supported by the 167A British-Spanish Integrated Action and the DGICYT PB92-875.

NOTE ON CRUSTACEANS RECORDED ON DOLPHINS INCIDENTALLY CAUGHT IN THE NORTHEASTERN ATLANTIC

Laurent Soulier and Anne Collet

Centre de Recherche sur les Mammifères Marins, Musée Océanographique, Port des
Minimes, 17000 La Rochelle, France.

INTRODUCTION The aim of the present study is to determine the possible impact of crustacean epizooism and ectoparasitism in small cetaceans from the northeastern Atlantic. Crustaceans were recorded by trained observers on dolphins incidentally caught by the French albacore driftnet fishery during 1992 and 1993 seasons.

MATERIALS AND METHODS The sample consists of 181 common dolphins (*Delphinus delphis*) and 450 striped dolphins (*Stenella coeruleoalba*), examined on board the fishing vessels. Parasites and epizoots were collected during the necropsies and preserved in 70% ethanol. They have been determined and measured under microscope.

The ages of the dolphins have been estimated from the number of dentinal growth layers, and their reproductive status has been determined from histological section in their gonads (80% of dolphins caught in the nets were younger than six years old and sexually immature).

RESULTS AND DISCUSSION Table 1 shows that the prevalences of crustaceans are very low, less than 1% for *Conchoderma auritum*, *Isocyamus delphini* and *Xenobalanus globicipitis* in striped dolphins, and close to 3% for *X. globicipitis* in common dolphins.

The epizoot *C. auritum* and ectoparasite *I. delphini* were found for the very first time on striped dolphins. However, they had been previously identified in other species in the same area and within a similar microhabitat (Balbuena, 1991; Clarke, 1966; Raga, 1985). The prevalence of these crustaceans appears too low to be considered as biological tags for common and striped dolphins in the northeastern Atlantic.

Seven specimens of the barnacle *C. auritum* were collected on the left upper jaw from a male striped dolphin of 29 years old. As the epizoots were embedded in the gum, radiographies were necessary to examine a possible pathological incidence. No line of fracture appeared but an osteoclasia near the implantation of epizoots and several teeth dislocations were noticed. In fact, the macroscopic deformation of the jaw was due to an hyperplasia of fibrous tissue. Complete occlusion of the mouth was not possible. However, the animal could normally eat since its stomach was full when autopsied. Previous references suggest that *C. auritum* is mainly embedded in an already deformed jaw (Clarke, 1966; Perrin, 1969). Although turbulences formed by the tooth dislocation or a fragility of the jaw may facilitate the fixation of barnacles, a direct influence of the epizoot on the host cannot be excluded.

Three specimens of the cyamid *I. delphini* were recorded on the skin, near the blowhole, in a 0.2 year old male striped dolphin. The low infestation intensity did not induce any pathological response.

The cirriped *Xenobalanus globicipitis* (58 specimens) has been collected on the flukes of five common dolphins and four striped dolphins. It appeared that this cirriped was found mainly on female common dolphins and male striped dolphins (Table 2) but, because no behaviour difference can explain such a phenomenon, this may be due to the small sample size. The average infestation frequency was 7.25%, and no pathological incidence has been noticed. A significant correlation appeared between length of the epizoots and the age or total body length of dolphins ($r_1 = 0.58$ and $r_2 = 0.45$) when the host is younger than five

years old (Figs. 1 & 2), which suggest that this cirriped parasitises young dolphins and then grows together with its host.

CONCLUSIONS The low prevalence and intensity of crustaceans sampled can only have a negligible impact on the common and striped dolphins involved. Nevertheless, ectoparasites and epizoids may induce pathological effects on some of their hosts. Of course, other investigations, carried out in the Atlantic as well as in other seas, are necessary to confirm the present results.

ACKNOWLEDGEMENTS Thanks are due to those observers who travelled on board the tuna fishing vessel, and who collected the samples, and to the staff of the Musée Océanographique de La Rochelle, for their assistance throughout the present study. Special thanks are due to Prof. J.A. Raga (University of Valencia) who confirmed the identifications of parasites.

REFERENCES

- Balbuena, J. A. 1991 Estudio taxonomico y ecologico de la parasitofauna del calderon comun, *Globicephala melas* (Traill, 1809), en las aguas de Europa. *Th. Doct. Sci. Biol. Valencia*. 305pp.
- Clarke, R. 1966. The stalked barnacle *Conchoderma auritum*, ectoparasitic on whales. *Norsk Hvalf. Tid.*, 55: 153-163.
- Perrin, W. F. 1969. The barnacle, *Conchoderma auritum*, on a porpoise (*Stenella graffmani*). *J. Mammal*, 50 (1): 149-151.
- Raga, J. A. 1985 *Contribucion al estudio del parasitismo y demas asociaciones en los cetaceos dela peninsula iberica*. Th. Doct. Sci. Biol. 478 pp.

Table 1 Prevalence of crustaceans on dolphins.

parasite	host	prevalence (%)
<i>C.auritum</i>	<i>S.coeruleoalba</i>	0.2
<i>I.delphini</i>	<i>S.coeruleoalba</i>	0.2
<i>X.globicipitis</i>	<i>S.coeruleoalba</i>	0.9
	<i>D.delphis</i>	2.8

Table 2. Number and sex of dolphins infested by *X.globicipitis*.

sex	<i>S.coeruleoalba</i>	<i>D.delphis</i>
female	0	4
male	4	1

Figure 1 : Correlation between length of epizoit and age of host

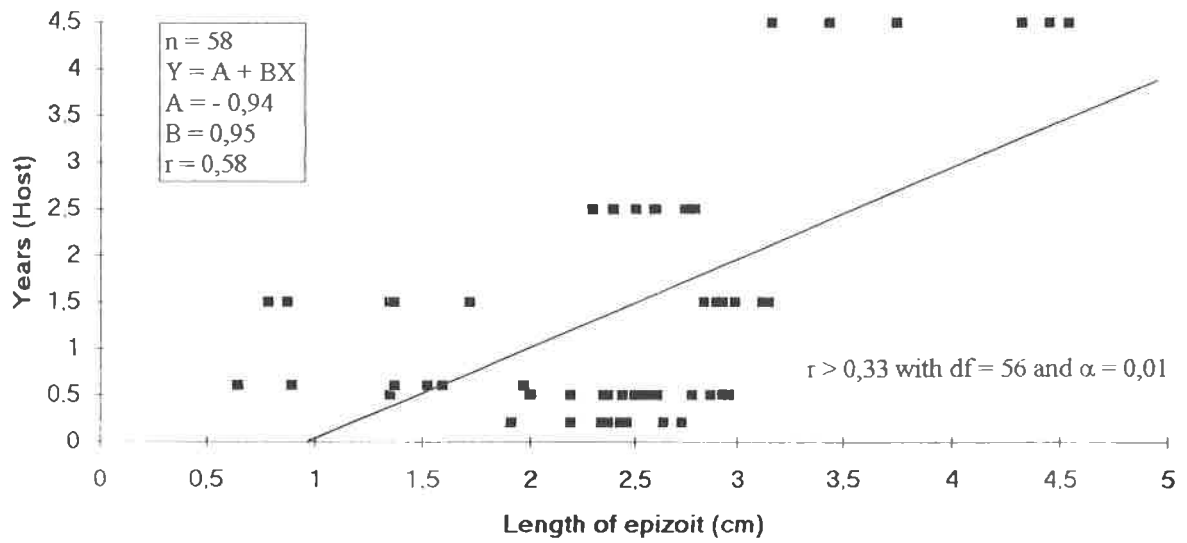
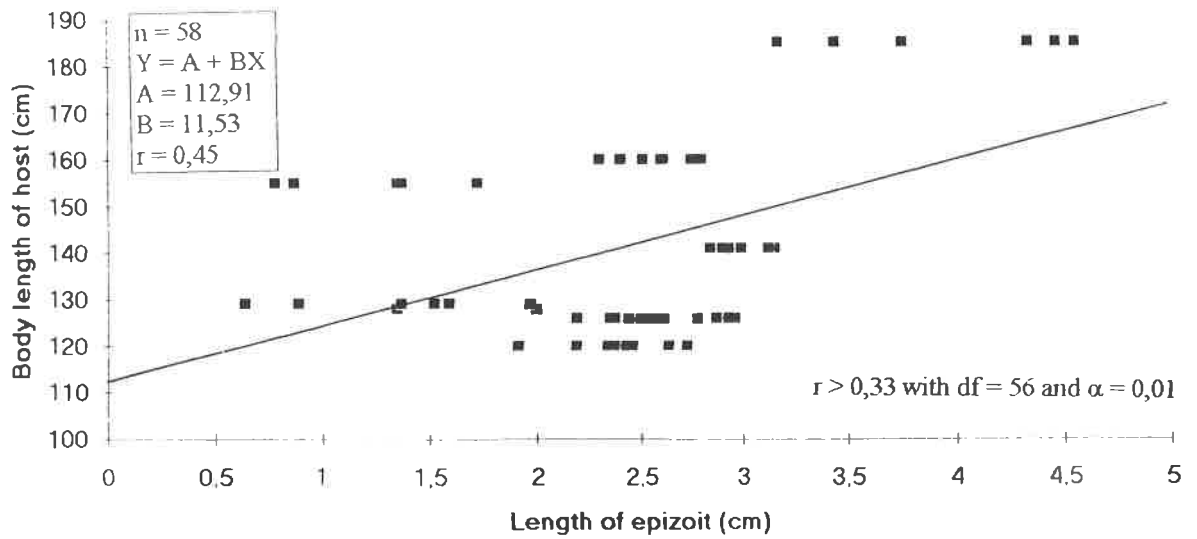

Figure 2 : Correlation between length of epizoit and body length of host



CYAMIDS (CRUSTACEA, AMPHIPODA) PARASITES OF CETACEANS OFF FRENCH MEDITERRANEAN COASTS

Guy Oliver* and Jean-Paul Trilles**

*Groupe d'Etude des Cétacés de Méditerranée (G.E.CE.M.),
Laboratoire de Biologie Végétale, Université de Perpignan,
52 avenue de Villeneuve, 66860 Perpignan Cédex, France

**Laboratoire d'Ecophysiologie des Invertébrés, Université de Montpellier,
II Place Eugène Bataillon, Case 92, F-34095 Montpellier Cédex 05, France

INTRODUCTION Cyamids are the only true parasitic amphipods. There are few observations about cyamids of the Mediterranean Sea (Figure 1): *Isocyamus delphini* (Guérin-Méneville, 1836) on long-finned pilot whale (*Globicephala melas*); *Syncyamus aequus* (Lincoln and Hurley, 1981) on striped dolphin (*Stenella coeruleoalba*); *Syncyamus* sp. on common dolphin (*Delphinus delphis*); *Syncyamus* sp. = *Cyamus chelipes* (Costa, 1866) on an unidentified dolphin; *Neocyamus physteris* (Pouchet, 1888) on sperm whale (*Physeter macrocephalus*).

MATERIALS AND METHODS Cyamids were collected on stranded cetaceans and fixed in 75% alcohol. These specimens were dehydrated in a graded alcohol series and subjected to critical point-drying for SEM examination.

RESULTS Recently, two species were collected on two Odontoceti stranded on the French Mediterranean coasts (Figure 1).

A single specimen of an unidentified species, perhaps *Isocyamus delphini*, was found near the blow-hole of a striped dolphin stranded near Toulon (Var, France). If verified, it will be the first record of this parasite on this host in the Mediterranean Sea.

On a young sperm whale stranded on the beach of La Nouvelle (Aude, France), there were attached several thousands of *Neocyamus physteris*. This represents only the second record for the Mediterranean Sea (Lloze and Daumas, 1985) (see also Figure 1).

As in other species, there are spurs on the three last pereon segments and on the articles of the pereopods, these structures facilitating the adherence of the parasite onto the cetacean's skin. Accessory gills are absent in males (Figure 2). Collected females were at different developmental stages: immature with two pairs of little oostegites (Figure 3), mature with two pairs of oostegites (Figure 4), ovigerous with a spherical brood-pouch (Figure 5), with young individuals in the marsupium (Figure 6), post-ovigerous with two pairs of appendages used for fixation and/or perhaps for the nutrition of larvae (Figure 7). Numerous specimens of both sexes were associated in pairs. The male, in dorsal position, was observed grasping the female at the base of the first pair of gills with the claw of the first gnathopods implanted in tissues. It is probably the normal copulatory posture (Figure 4). In adults, the maxillipeds have a palp with a single article (Figure 8) but some young specimens from the brood pouch have five articles, the last of which presents some "combs" at the tip (Figure 9). The number of gill filaments increases during development (Figure 10).

DISCUSSION AND CONCLUSIONS The life cycle of *Cyamus scammoni* (Dall, 1872), ectoparasitic on the gray whale *Eschrichtius robustus* is synchronised with the host migration. When the northward migration of the whales starts in spring, the cyamid larvae are fairly well developed (Leung, 1976) and support the current resulting from the fast swimming speed of the migrating host.

It seems that the reproductive period of *Neocyamus physteris* is possibly longer in the Mediterranean Sea, perhaps in relation to the temperature. However, a single observation is insufficient to determine whether the sperm whale is sedentary in the Mediterranean Sea.

Since cyamids have no free-swimming stage, infestation occurs necessarily after contact between two hosts; the same parasite living on different host species or populations should indicate a close relationship between them (Leung, 1970) (Figure 11). Thus, a connection between northern and southern sperm whale populations seems likely.

REFERENCES

Leung, Y. M. 1970. First record of the Whale-louse *Syncyamus* (Cyamidae: Amphipoda) from the Western Mediterranean, with notes on the biology of odontocete Cyamids. Invest. Cetacea, 2: 243-247.

Leung, Y. M. 1976. Life cycle of *Cyamus scammoni* (Amphipoda: Cyamidae), ectoparasite of the Gray Whale, with a remark on the associated species. Scient. Rep. Whales Res. Inst., 28: 153-160.

Lloze, R. and Dumas, M. 1985. De la présence de *Neocyamus physteris* (Pouchet, 1888), ectoparasite du Cachalot *Physeter macrocephalus* en Méditerranée. Act. 110e Congr. natn. Soc. sav., Montpellier, sect. Sci., 2:33-42.

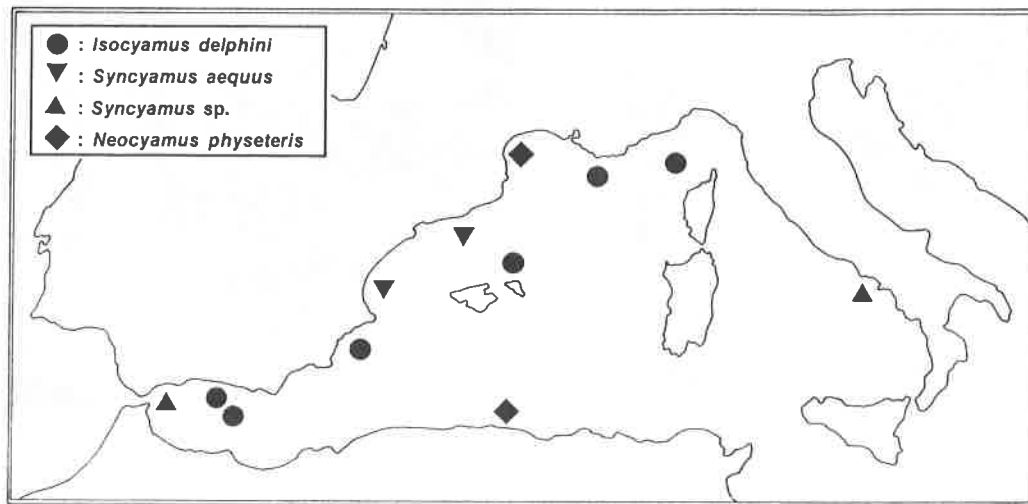

Fig. 1 - Observation sites of Cyamids parasites of Cetaceans in the Mediterranean Sea (according to some authors).

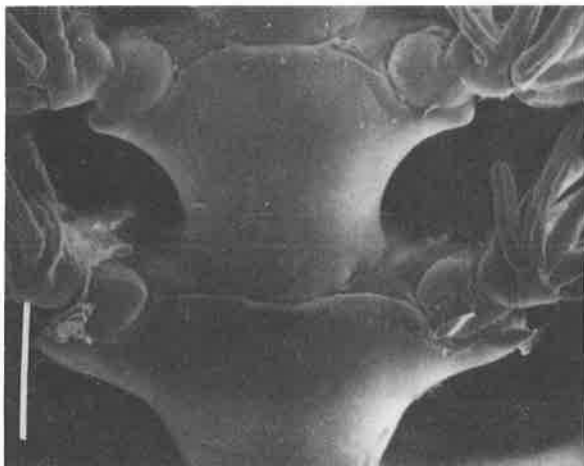

Fig. 2 - Male with two pairs of fasciculate gills (scale : 500 μ m).

Fig. 3 - Female with two pairs of little oostegites (scale : 500 μ m).

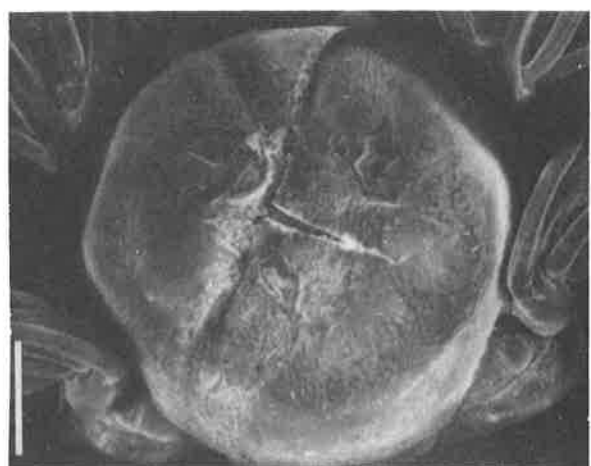
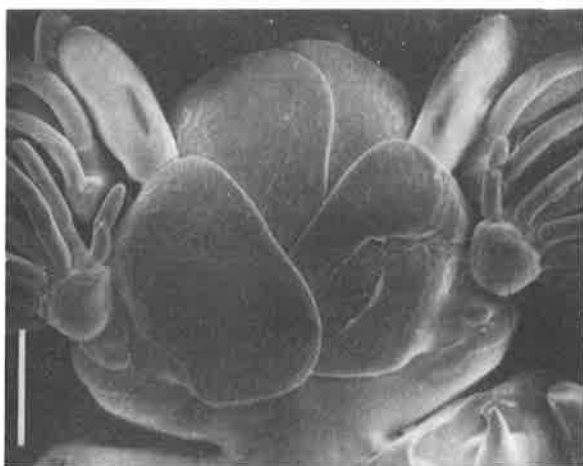

Fig. 4 - Mature female with developed oostegites (scale : 500 μ m).

Fig. 5 - Female with spherical brood-pouch (scale : 500 μ m).

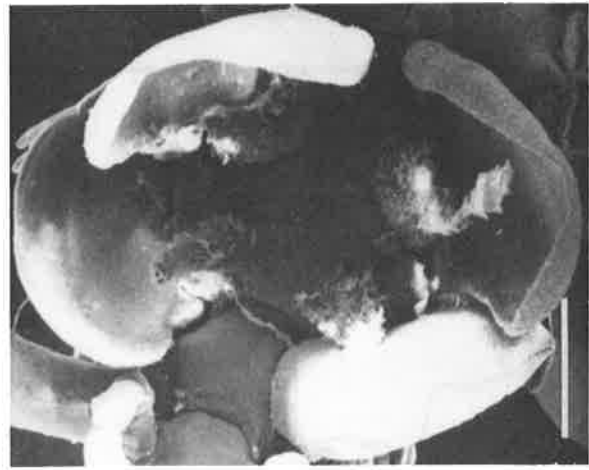
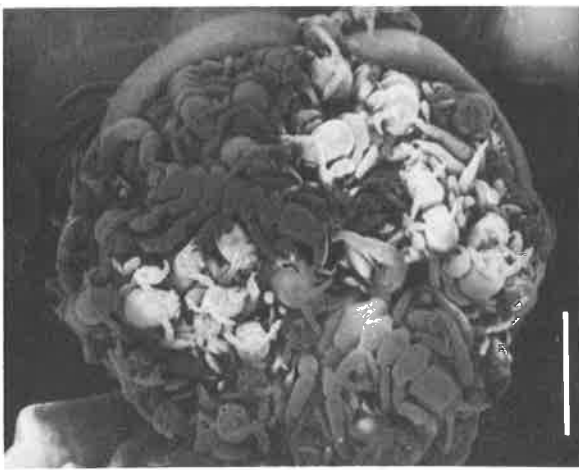

Fig. 6 - Female at the end of the gestation with developed young specimens in the brood-pouch (scale : 1 000 μ m).
 Fig. 7 - Brood-pouch empty after parturition (scale : 1 000 μ m).

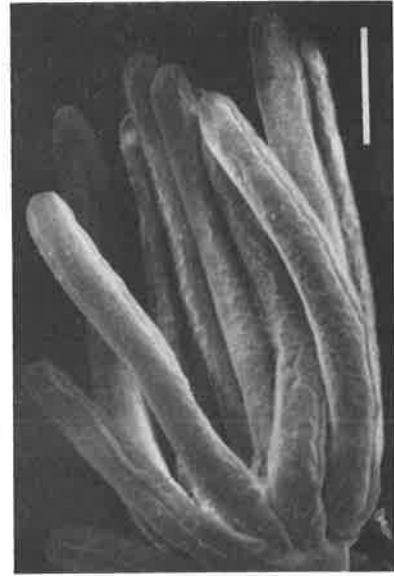
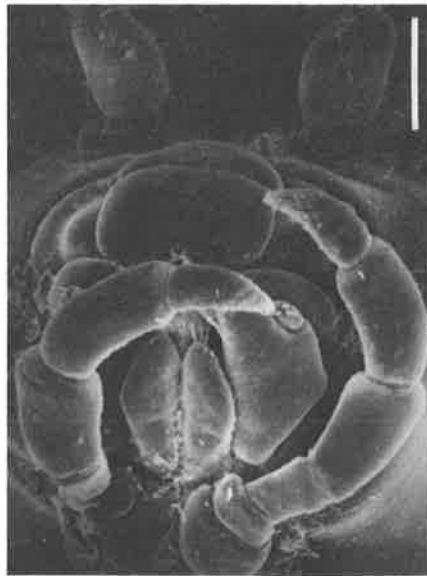
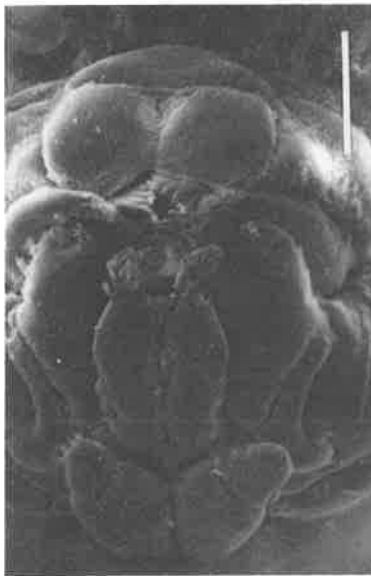

Fig. 8 - Buccal appendages of an adult (scale : 100 μ m).
 Fig. 9 - Buccal appendages of a young specimen from brood-pouch (scale : 75 μ m).
 Fig. 10 - Gill filaments of an adult (scale : 200 μ m).

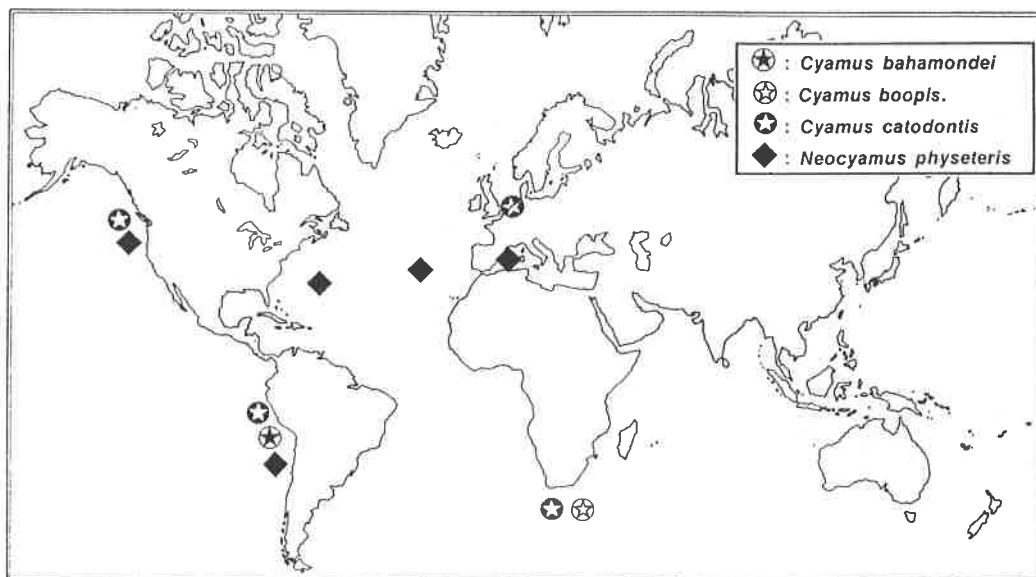

Fig. 11 - Observation sites of Cyamids parasites of Sperm-Whale (according to some authors).

**REDESCRIPTION OF *SYNCYAMUS AEQUUS* (AMPHIPODA: CYAMIDAE),
PARASITE OF STRIPED DOLPHIN *STENELLA COERULEOALBA*,
AND FIRST RECORD IN ITALIAN WATERS**

L. Mariniello, S. Cerioni and D. Di Cave

Instituto di Parassitologia, Università di Roma "La Sapienza", Roma 00185, Italy

Syncyamus aequus (Lincoln & Hurley, 1981), an amphipod parasite reported for the first time in South African waters, is re-examined in order to clarify the taxonomic value of some morphological characters not described in detail in the original description and in subsequent records (Raga, 1988; Sedlak-Weinstein, 1991).

Three females (two ovigerous) and six males were collected from two specimens of striped dolphin (*Stenella coeruleoalba*, Meyen, 1833) stranded along the Central Tyrrhenian coasts in 1988 and 1993. The amphipods, fixed and stored in 70% ethanol, were cleared with lactophenol for examination with the aid of a Leitz microscope drawing attachment.

The specimens examined showed the presence of spines located on pereopods I^o and II^o, which were lacking in the original description of *S. aequus*. The authors have had the opportunity to compare the specimens (male, female and ovigerous female) with the paratype (PEMK2g) deposited in the Natural History Museum of London. The present re-examination reveals a morphological homogeneity between the specimens collected in Italian waters, the paratype deposited in the Natural History Museum and the description of individuals recorded by Raga (1988), thus suggesting that they belong to the same species, having a broad geographical distribution.

This is the first record of *S. aequus* in Italian waters.

GENETIC VARIATION IN BOTTLENOSE DOLPHINS *TURSIOPS TRUNCATUS*

B. E. Curry*, V. G. Cockcroft** and A. E. Dizon***

*Marine Mammal Research Program and Dept. of Wildlife and Fisheries Sciences, Texas A&M University, College Station, Texas 77843 and Southwest Fisheries Science Centre

**Port Elizabeth Museum, Humewood 6013, South Africa

***Southwest Fisheries Science Centre, La Jolla, California, USA

Geographic variation in small cetaceans is often extreme, even over short distances, and phylogenetic relationships among bottlenose dolphin populations with both allopatric and sympatric distributions are unclear. Inshore and offshore forms are commonly recognised based on morphological and ecological evidence, and some investigators postulate the existence of multiple local populations inshore. The problem even extends to species level differences.

The genus *Tursiops* is currently considered to comprise only one species *T. truncatus*, but some researchers suggest the existence of several nominal species. An investigation on the status of one nominal species, *T. aduncus*, is included in the current study of population structure in bottlenose dolphins.

To compare individuals from the eastern North Pacific, western North Atlantic and Gulf of Mexico, and Indian Oceans, total genomic DNA was isolated from tissue samples of approximately eighty individuals, representing animals from different ocean basins, inshore/offshore forms, and local coastal populations. A portion of the mtDNA control region was amplified using polymerase chain reaction (PCR) procedures, and approximately 400 base pairs of the control region were sequenced. Genetic divergence was examined (using a variety of analytic methodologies) hypothesising geographic concordance with greater differences between animals having allopatric distributions.

GENETIC VARIABILITY OF STRIPED DOLPHIN *STENELLA COERULEOALBA* IN SPANISH MEDITERRANEAN WATERS

J. Garcia-Martinez*, A. Latorre*, and J. A. Raga**

* Genetics Department, University of Valencia, Dr. Moliner, 50,
46100 Burjassot, Valencia, Spain

**Animal Biology Department, University of Valencia, Dr. Moliner, 50,
46100 Burjassot, Valencia, Spain

INTRODUCTION Restriction analysis of mitochondrial DNA (mtDNA) is being used increasingly to calculate the degree of genetic variability as well as to examine population structure or population subdivision. In this way, mtDNA studies have been used to resolve different evolutionary problems in marine mammals: Baker *et al.*, (1990) correlated the seasonal migration with geographic distribution of mtDNA haplotypes in humpback whales; Dowling and Brown (1993) determined the population structure of bottlenose dolphin.

MATERIALS AND METHODS A total of 44 frozen muscle samples from striped dolphins (*S. coeruleoalba*) stranded on the Spanish Mediterranean coasts (including the Balearic Islands) were analysed, nine of which belonged to a post-epizootic period. For the spatial and temporal analysis, the samples were grouped into four geographic areas (see Figure 1) and four temporal periods.

MtDNA was extracted using the protocol as described in Boursot *et al.* (1987) with some modifications. The DNA was digested with 15 endonucleases and mtDNA restriction fragments were visualised by means of Southern Blotting. The labelled Commerson's dolphin mtDNA was used as a probe (Southern *et al.*, 1988).

RESULTS AND DISCUSSION The size of the striped dolphin mtDNA molecule was estimated to be 16.3 Kilobase pairs (Kb). Figure 2 shows the mtDNA cleavage map of the 15 restriction enzymes, with the conserved and polymorphic sites. The estimates of the number, d , of the nucleotide differences per site between pairs of haplotypes (Table 1) were obtained by the maximum likelihood estimation method (Nei 1987). Based on d values, a dendrogram (Figure 3) was obtained by the UPGMA method. Taking into account the d values as well as the frequencies of the 15 haplotypes, the total nucleotide diversity, π , from mtDNA of striped dolphin is 0.0023. By means of haplotype frequencies, the haplotype diversity, H (average heterozygosity) was calculated as 0.7886. These values are in the same range as those found in other cetaceans.

MtDNA differentiation within and between populations was estimated for both geographic and temporal distributions of individuals and haplotypes. The mean mtDNA differentiation within populations was found by averaging v_w to be 0.00253 for the geographic distribution and 0.00219 for the temporal distribution, while the values for the mean mtDNA variation between populations, v_b , were -0.00004 and 0.00001, respectively. These values indicate that there is no obvious population structuring. In fact, the N_{ST} values (-0.016 and 0.003, for the geographic and temporal distributions, respectively) are low enough to indicate null population subdivision (Lynch and Crease 1990).

The absence of a significant population structure as determined by mtDNA analysis, and the existence of shared haplotypes among populations, is indicative of high gene flow among them. We therefore consider that all individuals analysed belonged to the same western Mediterranean population. These results also indicate that in western Mediterranean waters, striped dolphins show a degree of genetic variability sufficiently high to suggest that it was not genetic causes which helped expansion of the epizootic process. The affected individuals did not belong to a discrete genetically primed sub-population.

REFERENCES

- Baker, C. S., Palumbi, S. R., Lambertsen, R. H., Einrich, M. T., Calambokidis, J. and O'Brien, S. J. 1990. Influence of seasonal migration on geographic distribution of mitochondrial DNA haplotypes in humpback whales. *Nature, Lond.*, 344: 238-240.
- Boursot, P., Yonekawa, H. and Bonhomme, F. 1987. Heteroplasmy in mice with deletion of a large coding region of mitochondrial DNA. *Mol. Biol. Evol.*, 4: 46-55.
- Dowling, T. E. and Brown, W. M. 1993. Population structure of the bottlenose dolphin (*Tursiops truncatus*) as determined by restriction endonuclease analysis of mitochondrial DNA. *Mar. Mam. Sci.*, 9: 138-55.
- Lynch, M. and Crease, T. J. 1990. The analysis of population survey data on DNA sequence variation. *Mol. Biol. Evol.*, 7(4): 377-394.
- Nei, M. 1987. *Molecular evolutionary genetics*. Columbia Press. New York.
- Southern, S. O., Southern, P. J. and Dizon, A. E. 1988. Molecular characterization of a cloned dolphin mitochondrial genome. *J. Mol. Evol.*, 28: 32-42.

Table 1. Genetic differentiation between the 15 mtDNA haplotypes of *S. coeruleoalba* estimated as d , the number of substitutions per site (Nei 1987). Values are multiplied by 100.

Haplotype	I	II	III	IV	V	VI	VII	VIII	IX	X	XI	XII	XIII	XIV
I	-													
II	0.151	-												
III	0.151	0.306	-											
IV	0.151	0.306	0.300	-										
V	0.154	0.312	0.306	0.306	-									
VI	0.300	0.457	0.148	0.148	0.457	-								
VII	0.306	0.154	0.457	0.457	0.465	0.607	-							
VIII	0.306	0.465	0.457	0.457	0.465	0.607	0.618	-						
IX	0.306	0.154	0.457	0.457	0.465	0.607	0.306	0.618	-					
X	0.457	0.618	0.607	0.300	0.618	0.449	0.769	0.151	0.769	-				
XI	0.457	0.306	0.607	0.607	0.618	0.755	0.457	0.769	0.151	0.919	-			
XII	0.457	0.618	0.300	0.300	0.618	0.148	0.769	0.769	0.769	0.607	0.919	-		
XIII	0.306	0.465	0.151	0.457	0.465	0.300	0.618	0.618	0.618	0.769	0.769	0.457	-	
XIV	0.457	0.306	0.300	0.300	0.618	0.148	0.457	0.769	0.457	0.607	0.607	0.300	0.457	-
XV	0.306	0.465	0.457	0.151	0.465	0.300	0.618	0.618	0.618	0.769	0.769	0.457	0.618	0.457

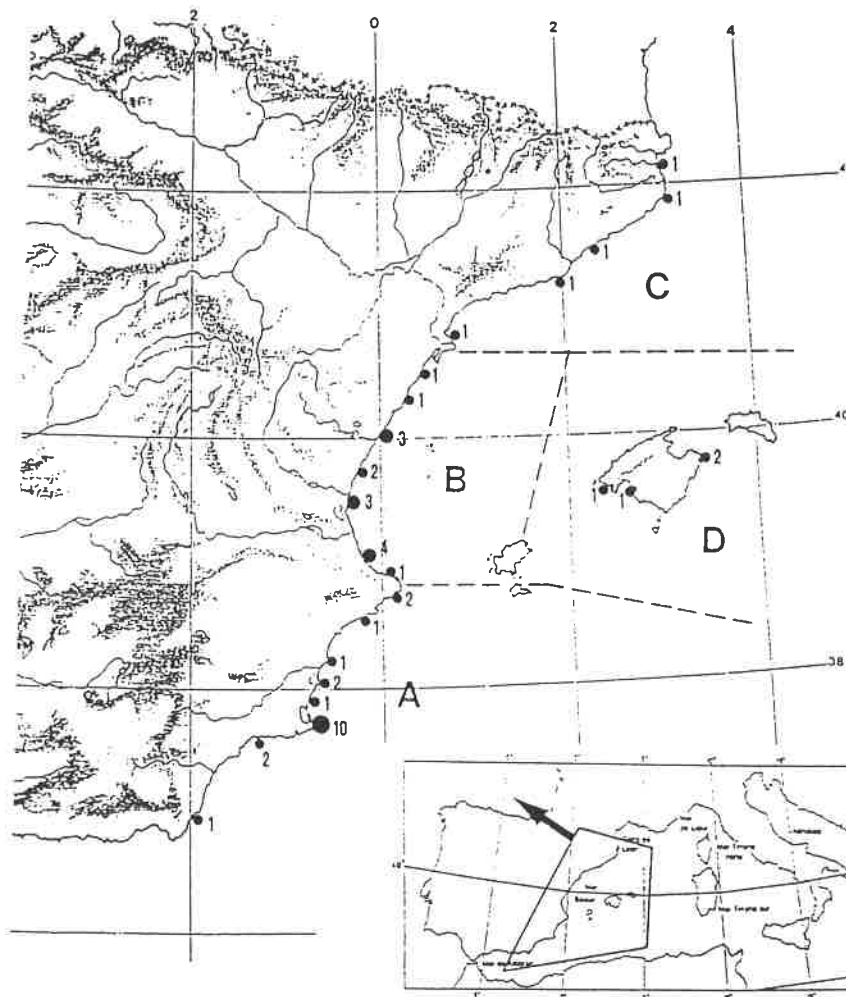

Figure 1. Distribution of *S. coeruleoalba* samples along the Spanish Mediterranean coasts. Numbers indicate sample sizes. Letters indicate the areas of geographic distribution of the samples. A, South Cabo de la Nao; B, From Cabo de la Nao to Delta del Ebro; C, North Delta del Ebro; D, Mallorca.

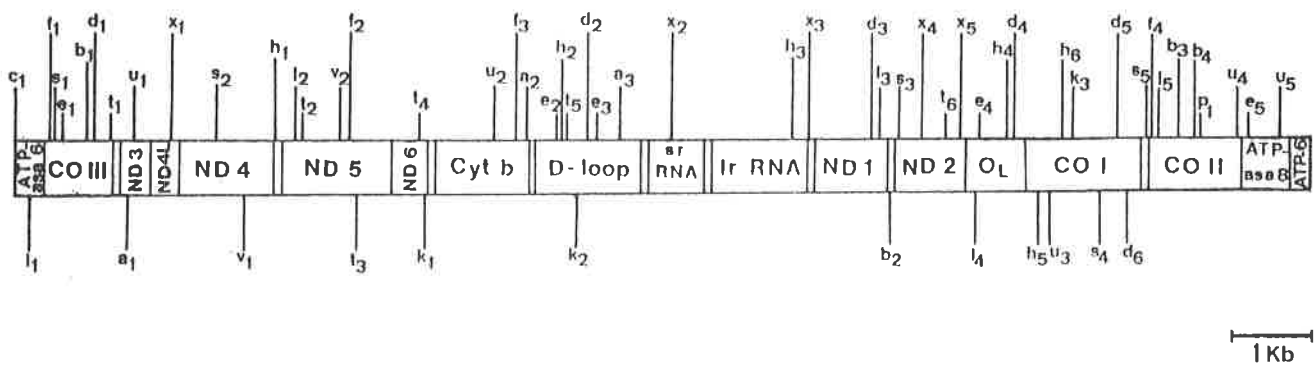

Figure 2. *S. coeruleoalba* mtDNA organization based on the genetic map of *C. commersonii* and *D. delphis* mtDNA given by Southern et al. (1988). Conserved sites are shown above and polymorphic sites below the map. Abbreviations for the genes are as follows: srRNA and lrRNA, small and large subunits of ribosomal RNA, respectively; ND1-6, subunits of the NADH dehydrogenase complex; Cytb, cytochrome b; COI-III, subunits of cytochrome oxidase; D-loop, regulatory noncoding region. Each site is named with a letter, for each one of the restriction endonucleases, followed by a number corresponding to a specific restriction site: a, *Bam*HI; b, *Bst*EII; c, *Cl*aI; d, *Dra*I; e, *Eco*RI; f, *Eco*RV; h, *Hind*III; k, *Kpn*I; l, *B*clI; p, *Pst*I; s, *Sac*I; t, *Sca*I; u, *Sfu*I; v, *Pvu*II; and x, *Xba*I.

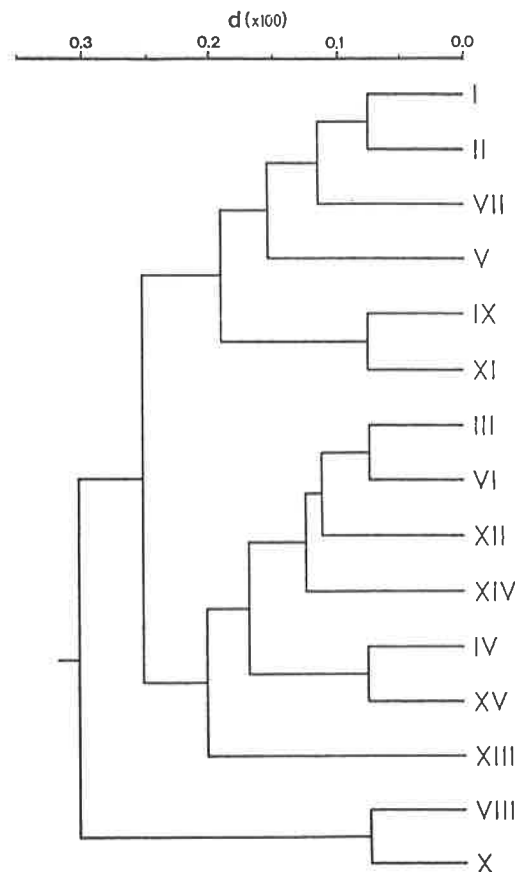

Figure 3. Dendrogram of the 15 haplotypes obtained by the UPGMA method (PHYLIP package, Felsenstein 1990), based on the values of the number, d, of the substitutions per nucleotide.

GENETIC DIVERSITY OF HARBOUR PORPOISE POPULATIONS AROUND THE BRITISH ISLES: PRELIMINARY RESULTS

Michael Walton

Sea Mammal Research Unit,
High Cross, Madingley Road, Cambridge, CB3 0ET, UK

INTRODUCTION Direct sequence analysis of amplified DNA enables the detection of all mutations within a specified segment of DNA and provides a tool for genetic comparisons of populations (Kocher *et al.*, 1989). In the present study the population sub-structure of harbour porpoises (*Phocoena phocoena*) found in the waters around the British Isles and Ireland is being studied by examining the genetic diversity of the control region of mitochondrial DNA (mit DNA).

METHODS DNA has been extracted by standard procedures from tissue samples of over 130 individual porpoises which were stranded or bycaught. So far, sequences have been obtained from fifty of them, and these animals were from the Shetland Islands (18), eastern English North Sea (14), English Channel (4) and the Irish Sea (14).

Sufficient quantities of the control region DNA were obtained via the polymerase chain reaction (PCR) using primers designed to produce a segment 471 base pairs (bp) long including the first 420 bases of the 5' end of the L-chain. The amplified double-stranded PCR products were purified to remove excess primers, etc. and then sequenced using Sequenase kits in both directions (McPherson *et al.*, 1993). This has allowed about 380-400 bases of the control region, starting from the 5' end of the L-strand, to be sequenced.

RESULTS In the 50 sequences, 26 variable sites have been found, of which 75% occur once only. The most frequently occurring polymorphic sites are located in the first 200 bases of the L-strand sequence. All these variable sites were transitions of which the number of A<->G (n=12) and C<->T (n=14) changes were similar. Figure 1 lists the 19 different haplotypes that were found, and Table 1 shows how they were distributed among the different locations.

The average nucleotide diversity d (measured as the mean pairwise % difference) between these sequences, within and among each 'population' is shown in Tables 2 and 3. Because of the low sample size, inter-regional differences involving the English Channel samples are omitted.

A preliminary analysis of the significance of inter-regional differences (g) was performed by a method analogous to that described by Palumbi *et al.* (1991) with Monte Carlo resampling (Table 4).

CONCLUSIONS In common with many other studies, most of the genetic diversity found was within, rather than among, populations. The results so far do not show any significant differences between porpoises from East England compared with the Irish Sea, or East England compared with Shetland. A small but significant difference is apparent between the Shetland and Irish Sea porpoises. More animals will be sequenced to increase the sample size for each area, and the frequencies of genotypes between areas will be further compared, as will the possible effects of sex, season, etc.

Table 1 Distribution of the 19 haplotypes among the four porpoise 'populations'

	Shetland	E England	Channel	Irish Sea	Total
A	8	5	3	4	20
B	0	2	0	0	2
C	0	1	0	6	7
D	2	0	0	0	2
E	2	0	0	0	2
F	1	1	0	1	3
G	1	1	0	0	2
H	1	0	0	0	1
I	1	0	0	0	1
J	0	1	0	0	1
K	0	1	0	0	1
L	0	1	0	0	1
M	0	1	0	0	1
N	0	0	1	0	1
O	0	0	0	1	1
P	0	0	0	1	1
Q	0	0	0	1	1
R	1	0	0	0	1
S	1	0	0	0	1
Total	18	14	4	14	50

Table 2 Within population genetic diversities

Region	n	d	St Dev	Bootstrap St Dev
Shetland Isles	18	0.789	0.594	0.152
East England	14	0.631	0.409	0.112
Channel	4	0.128	0.140	0.066
Irish Sea	14	0.551	0.403	0.118
All animals	50	0.660	0.484	0.077
(19 genotypes)	19	1.074	0.442	0.106

(number of bootstrap tests = 1000)

Table 3 Within and among population genetic diversities

	Shetland	E England	Irish Sea
Shetland (n=18)	0.7893	0.0000	0.0726
E England (n =14)	0.7102	0.6312	0.0008
Irish Sea (n=14)	0.7448	0.5939	0.5551

diagonal \ = within population % diversity = d
 below diagonal = between % diversity= dt
 above diagonal = between corrected for within = dt - ds,
 where ds = (d¹+d²)/2

Table 4 Inter-population comparisons where $g = (dt-ds)/dt$

Comparison	Sample g	p
Shetland vs East England	-0.0001	0.37
Shetland vs Irish Sea	0.0975	0.03*
East England vs Irish Sea	0.0014	0.30

THE MICROSCOPIC STRUCTURE OF THE LUNG IN CETACEA: PHYLOGENETIC CONSIDERATIONS

A. Bortolotto*,**

*Università degli Studi di Milano Dipartimento di Biologia,
Sezione di Zoologia e Citologia, via Celoria 26, 20133 Milano, Italy

**Present address: Fondazione Cetacea, viale Milano 63,
47036 Riccione (FO), Italy

INTRODUCTION Cetaceans are highly specialised mammals that show numerous anatomical and physiological adaptations that can be correlated with their recent option, from an evolutionary point of view, for a totally aquatic life.

Cetacean lungs are nonseptate, nonsegmented, contained in the pleuric cavity and positioned dorsally to a diaphragm more horizontal than in terrestrial mammals, allowing the expulsion of a high percentage of air in a relatively short period.

The larynx is connected to the lungs through the trachea with its cartilage rings that form an extensive cartilaginous armature, ideally suited for rapid and vigorous exchange of air, that in cetaceans extends into the smaller bronchioles provided sometimes with myoelastic sphincters.

These sphincters are possibly an adaptation to the fluctuations of air-pressure in the lungs during quick and frequent diving and surfacing, and especially during the violent inspiration and expiration of the smaller toothed whales (Goudappel and Slijper, 1958).

The muscular component provides a powerful mechanism for closure of the air sacs whereas the elastic component contributes, it would seem, to rapid evacuation of the air during expiration (Wislocki and Belanger, 1940).

The sphincters close at the end of inspiration when the lungs are filled, and remain closed until the onset of expiration (Wislocki, 1929), serving the function of maintaining the air in contact with the respiratory mucosa while the animal is submerged.

Such closure, imprisoning the air, could help in preventing the alveolar collapse with the increasing pressure on the thoracic wall during dives that have reached during trained experimental dives a depth of 535 m in bottlenose dolphins (*Tursiops truncatus*), and a depth of 646 m in beluga (*Delphinapterus leucas*) (Shippee *et al.*, 1993).

These myoelastic sphincters seem to appear in the Order Cetacea (Brisson, 1762) in relation to the adopted diving method which is likely to reflect feeding behaviour. However, this is not simply in relation to the "accentuated power of submerging", as previously suggested by Wislocki and Belanger (1940) but with the frequency of diving.

It is reasonable to assume that the myoelastic sphincters are a recent and exclusive specialisation, since bundles of smooth muscle positioned by the cartilaginous armature exist in all cetaceans so far examined.

AIMS Nowadays the phylogeny of cetaceans is still uncertain. Recently some revolutionary hypotheses, based on studies of molecular biology, have been proposed (Milinkovitch *et al.*, 1993).

I discuss the possibility of using the presence of an histological feature in the lungs of some cetaceans, the myoelastic sphincters, to verify the relationships between taxa, and to make a

contribution to the revised phylogeny of whales suggested by mitochondrial ribosomal DNA sequences.

MATERIALS AND METHODS In Italy, stranded cetaceans are collected by the Centro Studi Cetacei, (C.S.C.) of Milan, that is the Italian Stranding Network, and by the Fondazione Cetacea (F.C.) of Riccione that co-ordinates the rescue of live cetacean strandings with the support of Adriatic Sea World/Delphinarium Riccione (A.S.W.) of Riccione.

All the samples used in this study come from specimens stranded alive and subsequently, after their death, taken to the Istituto Zooprofilattico Sperimentale delle Regioni Lazio e Toscana in Rome for the necropsy.

After the dissection, the samples were fixed in SPAFG (Ermak and Eakin, 1976), washed in 0,1 M sodium-cacodylate-buffered solution, dehydrated through a graded scale of ethanol, embedded in either paraffin, JB-4 resin or Bioacryl, sectioned on a Rotary microtome Reichert-Jung 2045 Multicut at 0,5 - 5 μ m using glass blades and then coloured with several monochrome stains to give a polychrome result.

All the samples were tested from an histopathological point of view at the Istituto Superiore di Sanità in Rome by Dr. U. Agrimi and Dr. G. Di Guardo in order to avoid pathological structures being described mistakenly as normal.

I analysed the lungs of three toothed whale species belonging to the family Delphinidae (bottlenose dolphin, striped dolphin (*Stenella coeruleoalba*), Risso's dolphin (*Grampus griseus*), and one baleen whale, a member of the family Balaenopteridae (fin whale *Balaenoptera physalus*) as a comparison.

RESULTS The histological analysis of the lungs showed the presence of myoelastic sphincters in members of the family Delphinidae (bottlenose dolphin, striped dolphin and Risso's dolphin) and their absence in the fin whale, as expected. The description in the first two species (bottlenose and striped dolphin) is in agreement with previous studies (Goudappel and Slijper, 1958) while the description of the Risso's dolphin is the first in the literature.

DISCUSSION The results agree with the hypothesis that the presence of this feature in a given species is linked to diving behaviour: the myoelastic sphincters, among species so far examined, do not appear to occur in species characterised by deep and prolonged diving and of small lung capacity (Goudappel and Slijper 1958) but only in frequently breathing toothed whales with a large lung capacity.

They are totally lacking in the baleen whales and in the bigger toothed whales such as the Physeteridae (sperm whales) and some Ziphiidae (beaked whales) (Belanger, 1940; Goudappel and Slijper, 1958; Kooyman *et al.*, 1969).

Among the Ziphiidae, the Baird's beaked whale (*Berardius bairdii*, Stejneger 1883) does possess myoelastic sphincters; on the other hand, the northern bottlenose whale, (*Hyperoodon ampullatus*, Forster, 1770) lacks this feature despite being known for its diving performance, reaching a maximum recorded depth of 1,100 m (Morzer Bruyns, 1971), remaining underwater for up to 70 minutes (Benjaminsen *et al.*, 1979), and characterised by a small lung capacity. This confirms the doubtful systematic position of the family.

The Baird's beaked whale lacks the cartilage in the terminal bronchioles present in all other cetacean species examined.

The studies mentioned so far show the same problematic position of the family as revealed by molecular analyses. Thus it seems that there is a strong relationship between histological and molecular data concerning the phylogeny of Cetacea.

The family Physeteridae lack these sphincters and their lungs are indeed very similar to those of the baleen whales. Milinkovitch *et al.* (1993) state that the family Physeteridae appear to be more closely related to the baleen whales than to any other group of toothed whales and the simple histological results presented here agree with this conclusion.

ACKNOWLEDGEMENTS I kindly acknowledge Prof. G. Lanzavecchia and Dr. G. Scari of the Università degli Studi di Milano, Dipartimento di Biologia, Sezione di Zoologia e Citologia; Dr. G. Di Guardo, of the Istituto Zooprofilattico Sperimentale, Laboratorio di Medicina Veterinaria, and Dr. U. Agrimi, of the Istituto Superiore di Sanità in Rome, for the histopathological description of the lungs and for the striped dolphin sample; Martin Jones for help in making this presentation; and Stefania Bonomi for the drawings.

REFERENCES

- Belanger, L. F. 1940. A study of the histological structure of the respiratory portion of the lungs of aquatic mammals. *Am. J. Anat.*, 67: 437-461.
- Benjaminsen, T. and Christensen, I. 1979. The natural history of the bottlenose whale, *Hyperoodon ampullatus* Forster. Pp. 143-164. In *Behaviour of Marine Mammals* (Eds. H. E. Winn & B. L. Olla). Plenum Press, New York.
- Ermak, T. K. and Eakin, R. M. 1976. Fine structure of the cerebral and Pygidial Ocelli in *Chione ecaudata* (Polychaeta: Sabellidae). *Journal of Ultrastructural Research*, 54: 243-260.
- Goudappel, J. R. and Slijper, E. J. 1958. Microscopic structure of the lungs of the bottlenose whale. *Nature*, Lond., 182: 479.
- Gretarsdottir, S. and Arnason, U. 1993. Molecular studies on two variant repeat types of the common cetacean DNA satellite of the Sperm whale, and the relationship between Physeteridae (Sperm whales) and Ziphiidae (Beaked whales). *Mol. Biol. Evol.*, 10(2): 306-318.
- Kooyman, G. L. and Andersen, H. T. 1969. Deep diving. Pp. 65-94. In *The biology of marine mammals* (Ed. H. T. Andersen). Academic Press, New York.
- Milinkovitch, M. C., Orti, G. and Meyer, A. 1993. Revised phylogeny of whales suggested by mitochondrial ribosomal DNA sequences. *Nature*, Lond., 361(6410): 346-348.
- Morzer Bruyns, W. F. J. 1971. *Field guide of whales and dolphins*. Mees, Amsterdam.
- Shippee, S. F., Chun, N. K. W., and Williams, T. M. 1993. Conditioning Bottlenose dolphins (*Tursiops truncatus*) for voluntary diving studies. *Proceedings of the 20th Annual IMATA Conference*, Freeport, Bahamas, Nov. 1992.
- Wislocki, G. B. 1929. On the structure of the lungs of the porpoise (*Tursiops truncatus*). *Am. J. Anat.*, 44: 47-77.
- Wislocki, G. B., and Belanger, L. F. 1940. The lungs of the larger cetacea compared to those of smaller species. *Biol. Bull.*, 78: 289-297.

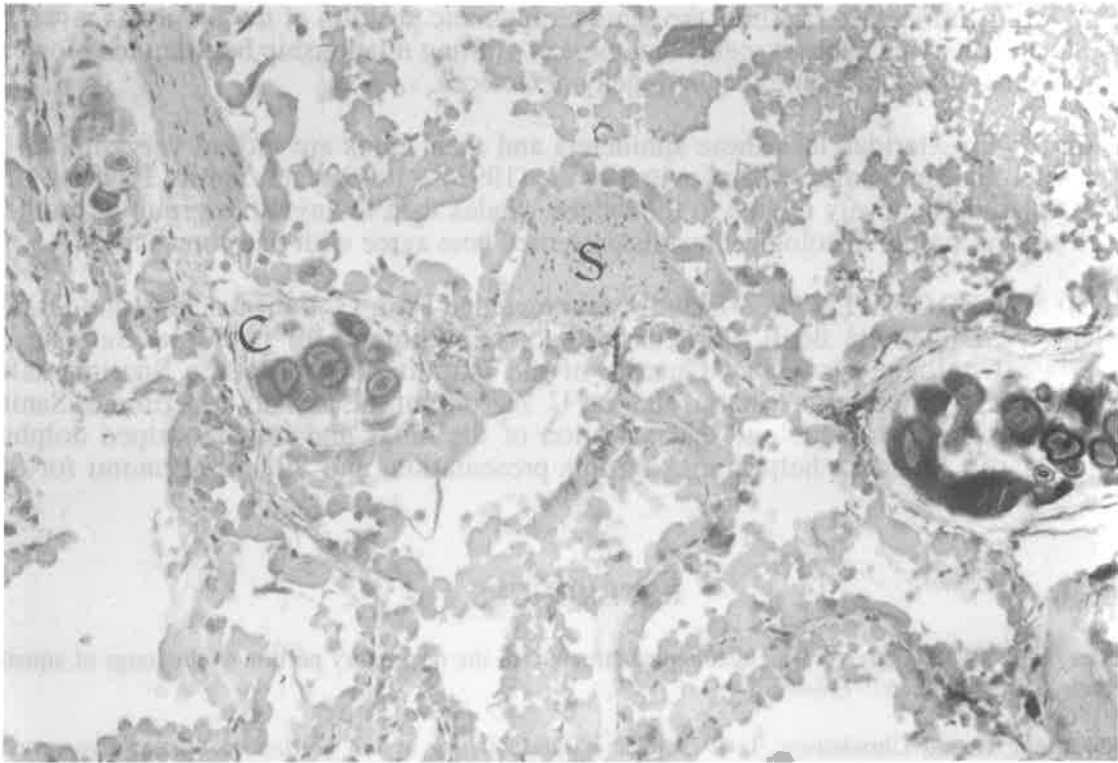

3 μ section of the lung of a Risso's dolphin (*Grampus griseus*)
(x 250)
Embedded in JB-4 / Lee method, Blue toluidene in borax, Acid fuchsin
(C = Cartilage rings; S = myoelastic sphincters)

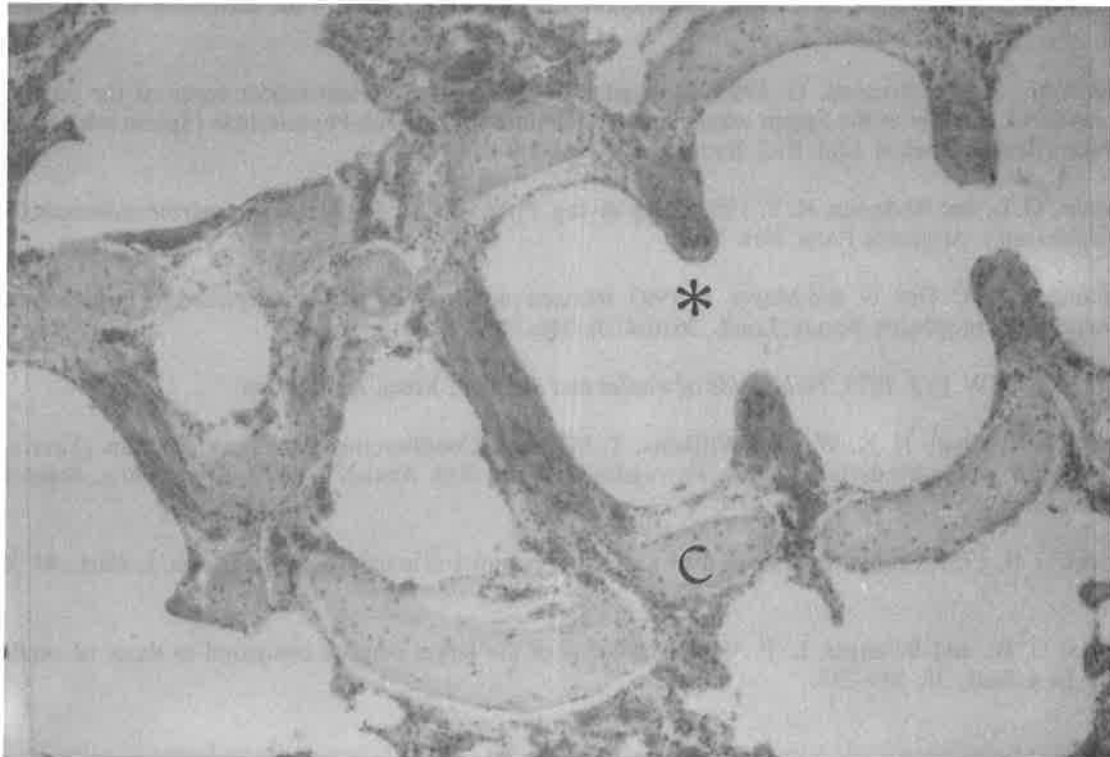

5 μ section of the lung of a striped dolphin (*Stenella coeruleoalba*)
(x 120)
Embedded in paraffin / ematoxilin-eosin
(C = Cartilage rings; * = myoelastic sphincters)

THE RENIN-ANGIOTENSIN SYSTEM IN A STRIPED DOLPHIN *STENELLA COERULEOALBA* KIDNEY

M.A. Masini, N. Veirana, M. Würtz and B.Uva

Istituto di Anatomia Comparata, Università di Genova,
v. le Benedetto xv n.5, 16132 Genova, Italy

INTRODUCTION The main source of freshwater in the dolphins (Delphinidae) comes from food. Dolphins drink only small amounts of seawater (Hui, 1981), and they produce a small volume of concentrated urine which is normally similar to that of other terrestrial mammals (see Gaskin, 1986). The hormonal control of salt and water homeostasis is still under investigation. Previous old data need revision owing to the different techniques employed. The main osmoregulatory system, also involved in blood pressure, is the renin-angiotensin system (RAS) whose enzyme renin is produced (in the kidney) in the juxtaglomerular apparatus. Cowan (1966) described in dolphins a very large macula densa, and an enzyme renin, chemically and physiologically similar to that of other mammals, was also identified (Malvin and Vander, 1967).

The aim of the present study is to investigate for the presence of the RAS in a dolphin - the striped dolphin (*Stenella coeruleoalba*). Renin Activity (RA) and Angiotensin Converting Enzyme Activity (ACE) were investigated by radioimmunoassay and spectrophotometric assay respectively, Angiotensin II (Ang II) and Ang II binding sites were identified by immunohistochemistry and autoradiography.

MATERIALS AND METHODS Kidneys of adult and young *Stenella*, stranded on shores of the Tyrrhenian sea, were excised, Bouin fixed or frozen at -80°.

Renin activity was performed by radioimmunoassay of Ang I produced after incubation of the kidney extract with porcine angiotensinogen. ACE, expressed as nmol hippurate/min/mg protein, was performed at 37° after the Pre and Bladier method (1983). Controls were obtained, adding to the incubating mixture an ACE inhibitor (Captopril). Immunoreactive Ang II was studied on Bouin fixed sections, using Ab Ile⁵AngII (Peninsula) following immunohistochemical methods; Ang II binding sites were investigated on Bouin fixed sections by autoradiography using ¹²⁵I Ang II (Amersham) liquid phase technique.

RESULTS AND DISCUSSION The enzyme renin, present in the kidney extracts generated 28 pg Ang I /mg prot./h. ACE was 10.2 ± 4.3 nmol hippurate/min/mg protein. Immunoreactive Ang II was localised in the cortical zone of the *renicules* in the cells of the metanephric tubules close to the glomeruly (Fig.1). Ang II binding sites were localised along the metanephric tubules (Fig. 2).

In the kidney sections of young and adult animals, metallic granules were present in the cytoplasm of many cells and large haemorrhagic zones testified to the suffering of the tissue. The presence of the two key enzymes (renin and ACE) in the kidney homogenates indicates that a RAS, similar to that of terrestrial mammals, very likely regulates ion homeostasis and blood pressure in dolphins.

REFERENCES

- Cowan, D. F. 1966. Pathology of the Pilot Whale *Globicephala melaena*. Arch. Path., 82: 178-189.
- Gaskin, D. E. 1986. Kidney and water metabolism. Pp. 129-148. In *Research on Dolphins* (Editors M.M. Bryden and R.J. Harrison). Hedges, N.A.
- Hui, C. A. 1981. Seawater consumption and water flux in the common dolphin *Delphinus delphis*. Physiol. Zool., 54: 430-440.
- Malvin, R. L. and Vander, A. J. 1967. Plasma renin activity in marine teleosts and Cetacea. Amer. J. Physiol., 213: 1582-1584.
- Pre, J. and Bladier, D. 1983. A rapid and sensitive spectrophotometric method for routine determination of serum angiotensin-I-converting enzyme activity. ICRS Medical Science, 11: 220-221.

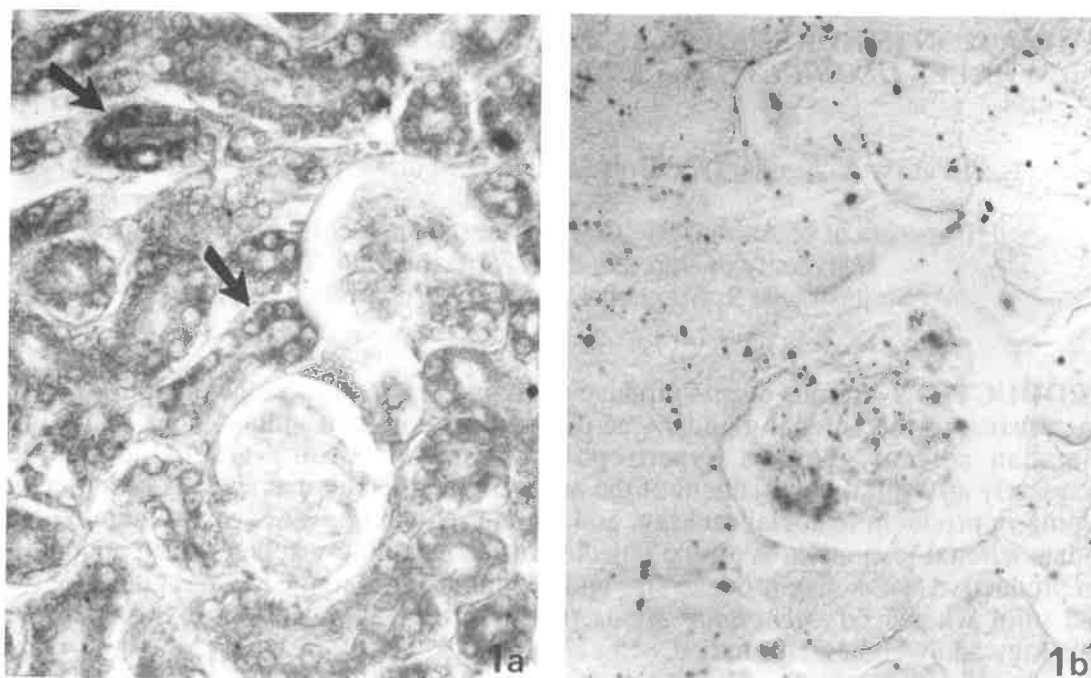

Fig. 1 a) Immureactive Ang II in the kidney tubules (arrows) of *Stenella*. PAP method. 340 X.

b) Control sections showing the metallic granules scattered in the tissue. No immunoreactivity is present. 340 X.

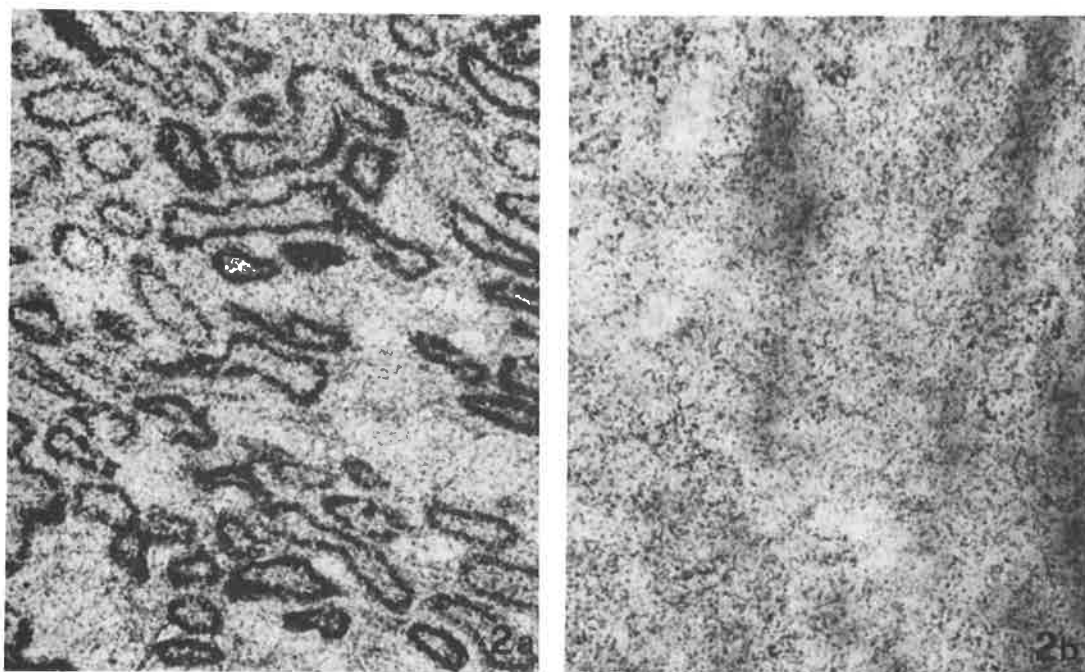

Fig. 2 a) Autoradiograph of *Stenella* kidney incubated with iodinated Ang II. 125 X.

b) Control section. 125 X.

VARIATION IN ADRENAL GLAND SIZE AND MORPHOLOGY IN PILOT WHALES *GLOBICEPHALA MELAS* FROM THE FAROE ISLANDS.

L. Silvani*, A. Aguilar*, A. Borrell *, G. Desportes**, and J. M. Gazo*

*Department of Animal Biology (Vertebrates), Faculty of Biology,
University of Barcelona, 08071 Barcelona, Spain

**Stejlestraede 9, Bregnor, DK-5300 Kerteminde, Denmark

INTRODUCTION Various events produce short and long term changes in morphological characteristics of the adrenal glands. One of the most common indicators of stress in the mammalian adrenal gland is hypertrophy of the cells of the adrenal cortex, and consequently an overall enlargement of the adrenal gland. Natural events such as breeding, crowding, reproduction, social ranking, and ageing may act as stressors in mammals and stimulate adrenal responses. With the objective of ascertaining whether nutritive condition and reproductive status may provoke size and weight changes in the adrenal glands of long-finned pilot whales *Globicephala melas*, the patterns of variation in adrenal gland morphology and weight were studied.

ENERGETICS OF REPRODUCTION IN PILOT WHALES Long-finned pilot whales from the Faroe Islands have a breeding cycle of 3-4 years, with conception peaks between April and June and parturition between July and mid-October. Gestation is about 14.5 months, lactation about 21 months and reproductive interval about 42 months (Martin and Desportes, 1987). Most pilot whale births in the Faroes coincide with movement into the area for feeding, from August onwards, and with subsequent winter fattening. In winter and early spring the food intake decreases, and a very lean condition appears at about the start of summer, after conception. Lactational demands may be met initially by feeding in the autumn and early winter, and later on from reserves in spring.

MATERIALS AND METHODS Adrenal glands and samples of dorsal blubber and gonads were collected from a pod of long-finned pilot whales caught in the bay of Midvagur in August 1987 by the Faroese drive fishery. In total, 47 animals (19 males and 29 females) were studied. Adrenal glands, collected between two and eight hours after the death of the animal, were carefully cleaned of surrounding tissues and weighed. Glands were preserved in 10% formalin, photographs of the section of the gland were taken, and the area of the cortical zone was determined with a digital analyser. The weights and the adrenal cortex areas used for the statistical analysis correspond to the average of the two glands of the same animal.

The nutritive state of the whale was determined by an analysis of the lipid content of the blubber from the dorsal region posterior to the dorsal fin. In order to establish differences between reproductive states, it was necessary to identify the reproductive condition of the specimens sampled through the study of the gonads and mammary glands of the animals. Finally, the weight of the animal was indirectly determined from its body length, according to a length-weight relationship obtained for North-east Atlantic pilot whales by Lockyer (1988).

RESULTS

Nutritive condition The analysis of lipid content in blubber, indicative of the overall energy status of individual specimens, showed that lactating females were in a significantly worse condition than other categories (Figure 1). This agrees with what was expected, that is, in late spring and the beginning of summer, lactation is covered by lipidic reserves.

Adrenal weight The pattern of variation in adrenal gland weight between the various reproductive categories shows that adrenal glands of pregnant, lactating, and both pregnant and lactating females are larger, and significantly heavier (Table 1), than the other

categories (Fig. 2). No significant differences were found between adrenal weights of mature and immature males.

Adrenal cortex area To ascertain whether differences in adrenal weight observed corresponded to an enlargement of the adrenal cortex, a test comparing means for the cortical area and the medulla area was performed between females actively involved in reproduction, and resting females. Results showed that the adrenal cortex of the former was significantly larger than that of the latter (Fig. 3). No differences were observed in the adrenal medulla size.

CONCLUSIONS According to our results, pregnancy and nursing in long-finned pilot whales may induce morphological changes in the adrenal gland by increasing adrenal weight. This increase is the result of the enlargement of the adrenal cortex, probably due to the action of increased levels of ACTH occurring during reproduction on the cortical zone and the increase in the production of glucocorticoids. This has been observed in other mammals, but the variation pattern is very wide, depending on the different species. Nutritional condition does not seem to act as a stressor itself, but it could enforce the reaction of the adrenal glands observed.

REFERENCES

- Lockyer C., 1989. Seasonal changes in body fat condition of Northeast Atlantic pilot whales, and its biological significance. IWC doc, SC/41/SM5.
- Martin A. R. and Desportes G. 1987. Preliminary studies of pilot whales from the Faroese waters since 1986: reproduction and fetal growth. IWC doc. SC/39/SM15.

Table 1 Analysis of covariance of adrenal weight between the different categories

	IMMATURE MALES	MATURE MALES	REPRODUCTIVE FEMALES
IMMATURE MALES			
MATURE MALES	NS		
REPRODUCTIVE FEMALES	0.05	0.05	
NON REPRODUCTIVE FEMALES	NS	NS	0.05

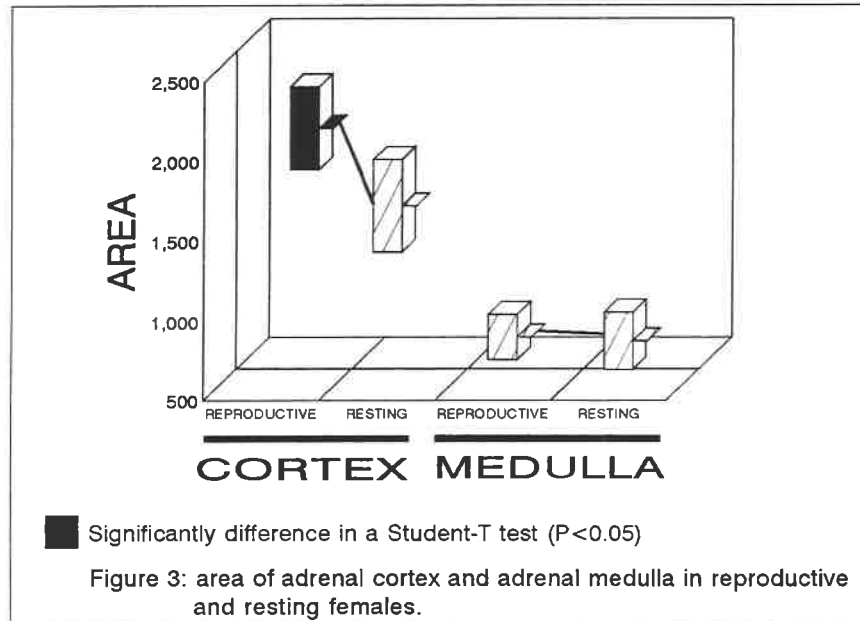
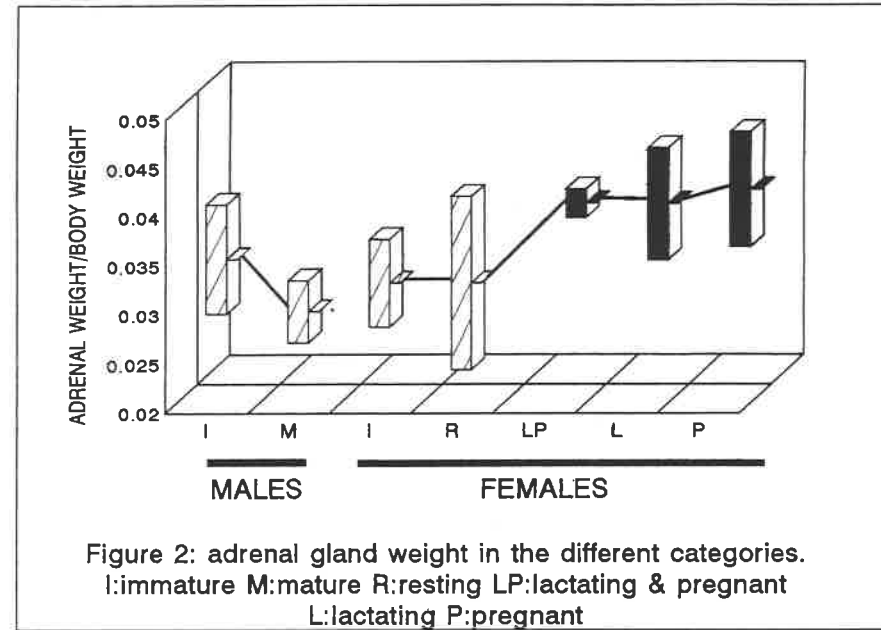
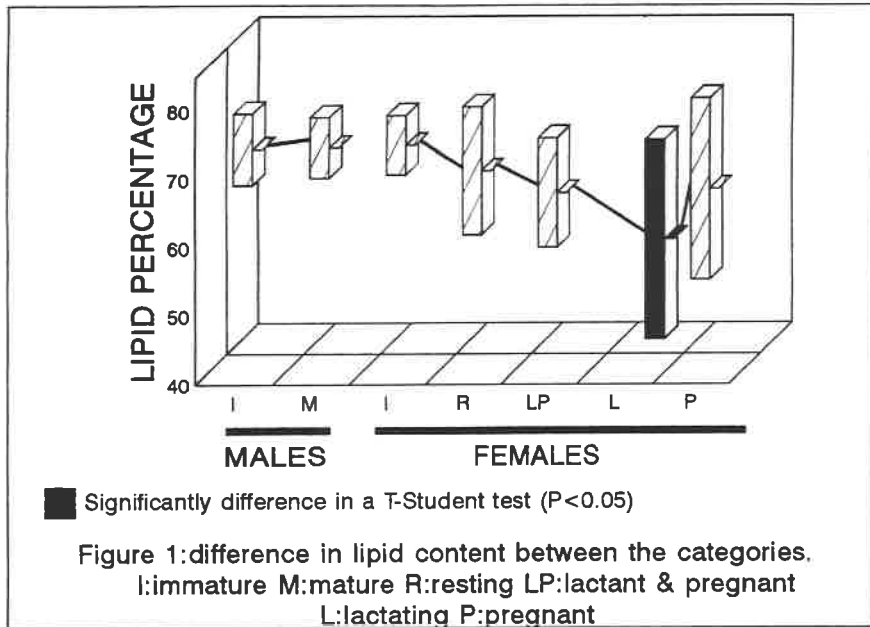

THE WEST WALES GREY SEAL CENSUS

Mick Baines, Chris Pierpoint, Powell Strong and Jim Poole

Dyfed Wildlife Trust, 7, Market Street,
Haverfordwest, Dyfed SA61 1NF, UK

INTRODUCTION West Wales holds the largest breeding population of grey seals (*Halichoerus grypus*) in southern Britain. The last survey of pup production in West Wales was carried out in 1974, by means of a single sweep of the coast at the height of the pupping season (Anderson, 1977). In 1991, the Countryside Council for Wales awarded a four year contract to the Dyfed Wildlife Trust to carry out a full census of the grey seal colonies off West Wales. In 1992, the project was extended to include a study of the diet of grey seals in West Wales.

OBJECTIVES

- 1) To locate and document all breeding sites in West Wales (defined as Caldey to Aberystwyth, Dyfed);
- 2) To count the number of pups at each of these sites at regular intervals throughout three consecutive breeding seasons in order to estimate pup production and the total population of grey seals of all ages;
- 3) To identify "areas" where seals are subject to disturbance by man, and where possible to monitor this disturbance and collect observations on their response;
- 4) To monitor the population by mark/recapture, using pelage markings;
- 5) To investigate the diet of grey seals in West Wales using faecal analysis.

METHODS

Site survey During the 1991 pupping season, the coast was thoroughly explored using small inflatable boats, and all sites with the potential of being used for pupping were documented (Baines, 1992). Caves were considered to be potential pupping sites if they contained beaches or accessible ledges above the high water level.

Pup census The study area was divided into manageable sections, each of which was swept by sea at least once every fortnight during the 1992 and 1993 seasons, from before the onset of pupping until no new pups were detected. The maximum census interval was set to ensure that pups were counted before weaning, shortly after which they may disperse from pupping sites. Each site was visited by swimmers working from an inflatable boat. Pups were recorded under five age classes, and dye-marked to prevent multiple counting.

Disturbance monitoring Regular periods of observation were maintained at selected haul-out sites during and outside the breeding season, recording observed reactions by seals to approach by boats and other potential forms of disturbance.

Diet study Faeces collected from haul-out sites between May 1992 and May 1993 were sieved and the hard parts recovered and stored in 70% ethanol. Otoliths were identified using reference collections and an identification guide (Harkonen, 1986) and measured to 0.01 mm using a low powered microscope.

RESULTS

Pup census More than 230 active sites have been located in the 220 km coast of the study area, of which some 110 are within caves and 120 are on beaches. The total number of pups counted in 1992 was 1,300 (Baines, 1993); in 1993, the total was 1,387 (Baines, Earl and Strong, 1994). Applying the factor originally derived by Hewer (1964), these data represent a total population of some 5,000 grey seals of all ages.

Diet study Results are presented as percentages of total weights for all seasons combined and by season within the year (Table 1).

DISCUSSION

Pup census The histogram of weekly pup production (Figure 1) illustrates the extended duration of the pupping season in West Wales, with pups produced over a period of 17 weeks. Pupping commences during August and continues until early December, reaching a peak at the end of September or beginning of October. The estimated population of 5,000 represents a significant increase over the previous estimate of 2,000 in 1974 (Anderson, 1977).

Disturbance monitoring Ramsey Island has one of the largest concentrations of breeding seals in southern Britain, producing 480 pups in 1992 (Baines and Pierpoint, 1993). Traditional displacement-hulled fishing boats have carried passengers around the island for many years; now tourist operators also use large inflatable boats, even entering some of the larger caves in which seals breed: some sites may be visited more than ten times each day at the peak of the tourist season. Observation during the 1993 season (Thomas, 1994) found no evidence to suggest this causes an increase in pup mortality before weaning. This disturbance only affects the first half of the season as the tourist boats are taken out of the water by the peak of the pupping season. While total pup production on the island has increased by more than 50% since the last estimate in 1974, the number of pups produced during the first half of the season has declined; the increase has been during the second half of the season, which has become prolonged by 60% (Figure 2). Comparison of 1992 and 1993 figures shows a 4% drop in pup production on Ramsey, with an equivalent increase on less disturbed areas of coast nearby. These findings suggest that disturbance may affect the selection of pupping sites by females approaching parturition, leading to changes in the distribution of pupping.

Diet study The number of samples analysed containing otoliths was small (n=51) so caution should be taken in interpreting the results. Flatfish and gadoids dominated the diet by weight for the periods February to August, with herring dominating the October and November period, suggesting opportunistic feeding on seasonally abundant prey species (Pierce *et al.*, 1990). The results support other studies showing grey seals usually feed on or near the sea bed and that dominant prey are benthic or demersal fish (e.g. Thompson *et al.*, 1991). Feeding on pelagic species such as herring may be a result of the fish being close to the sea bed at certain times, or a departure by seals from usual bottom feeding habits (Hammond *et al.*, 1993).

ACKNOWLEDGEMENTS The West Wales Grey Seal Census is funded principally by the Countryside Council for Wales, with additional support from Welsh Water - Dwr Cymru, The Pembrokeshire Coast National Park and Martini Ltd. The study of seal diet in West Wales is funded by the Countryside Council for Wales and the National Rivers Authority.

REFERENCES

- Anderson, S. S. 1977. The grey seal in Wales. *Nature in Wales*, 15, 3: 114-123.
- Baines, M. E. 1992. West Wales grey seal census - report on the 1991 survey. Dyfed Wildlife Trust unpublished report to the Countryside Council for Wales.
- Baines, M. E. 1993. West Wales grey seal census - report on the 1992 season. Dyfed Wildlife Trust unpublished report to the Countryside Council for Wales.
- Baines, M. E. and Pierpoint, C. J. L. 1993. Ramsey Island grey seal census 1992. Dyfed Wildlife Trust unpublished report to the Countryside Council for Wales.
- Baines, M. E., Earl, S. J. and Strong, P. 1994. West Wales grey seal census interim report on the 1993 season. Dyfed Wildlife Trust unpublished report to the Countryside Council for Wales.
- Hammond, P. S., McConnell, B. J. and Fedak, M. A. 1993. Grey seals of the east coast of Britain: distribution and movements at sea. *Marine Mammals: Advances in Behavioural and Population Biology*. (Ed. I. L. Boyd). Symp. Zool. Soc. Lond., 66: 211-224.

Harkonen, T. 1986. *Guide to the Otoliths of the Bony Fishes of the North-East Atlantic*. Danbiu ApS, Hellerup, Denmark. 256 pp.

Hewer, H. R. 1964. The determination of age, sexual maturity, longevity and a life table in the Grey seal (*Halichoerus grypus*). *Proc. Zool. Soc. Lond.*, 142: 593-624.

Pierce, G. J., Boyle, P. R. and Thompson, P. M. 1990. Diet selection in seals. Pp. 222-238. In *Trophic Relationships in the Marine Environment*. (Eds. M. Barnes and E. N. Wilson). *Proc. 24th Europ. Mar. Biol. Symp.*, Aberdeen University Press, Aberdeen.

Thomas, D. 1994. Observations on disturbance to breeding seals on Ramsey, 1993. Unpublished report to the Dyfed Wildlife Trust.

Thompson, D., Hammond, P. S., Nicholas, K. S. and Fedak, M. A. 1991. Movements, diving and foraging behaviour of grey seals (*Halichoerus grypus*). *J. Zool.*, 224: 223-232.

Table 1 Summary of diet study results

(a) number of otoliths and (b) percentage, by weight, of the major prey in the diet of grey seal between May 1992 and May 1993.

	<u>All Samples</u> n=51		<u>February / March / May</u> n=28		<u>July / August</u> n=8		<u>October / November</u> n=15	
	Number Otoliths	% by Weight	Number Otoliths	% by Weight	Number Otoliths	% by Weight	Number Otoliths	% by Weight
Whiting	136	10	13	5	108	38	15	3
Cod	20	2	4	2	7	3	9	4
Poor Cod	95	5	37	6	37	4	21	4
Bib	8	3	4	4	3	4	1	1
ALL GADIDS	373	27	126	19	158	48	89	29
Dab	24	3	4	1	14	9	6	3
Solenid spp.	224	30	192	44	16	13	16	8
Plaice	29	7	13	6	16	19	0	0
ALL FLATFISH	376	44	294	56	52	42	30	16
Herring	14	10	1	5	1	0	12	28
Dragonet	181	10	122	9	20	9	39	11
Sea trout	1	1	1	2	0	0	0	0
Black goby	56	1	15	0	0	0	41	2
Labrid spp.	129	3	71	3	0	0	58	6
Others	204	6	134	6	12	1	58	8

Number of samples analysed = 67

Number of samples containing otoliths = 51

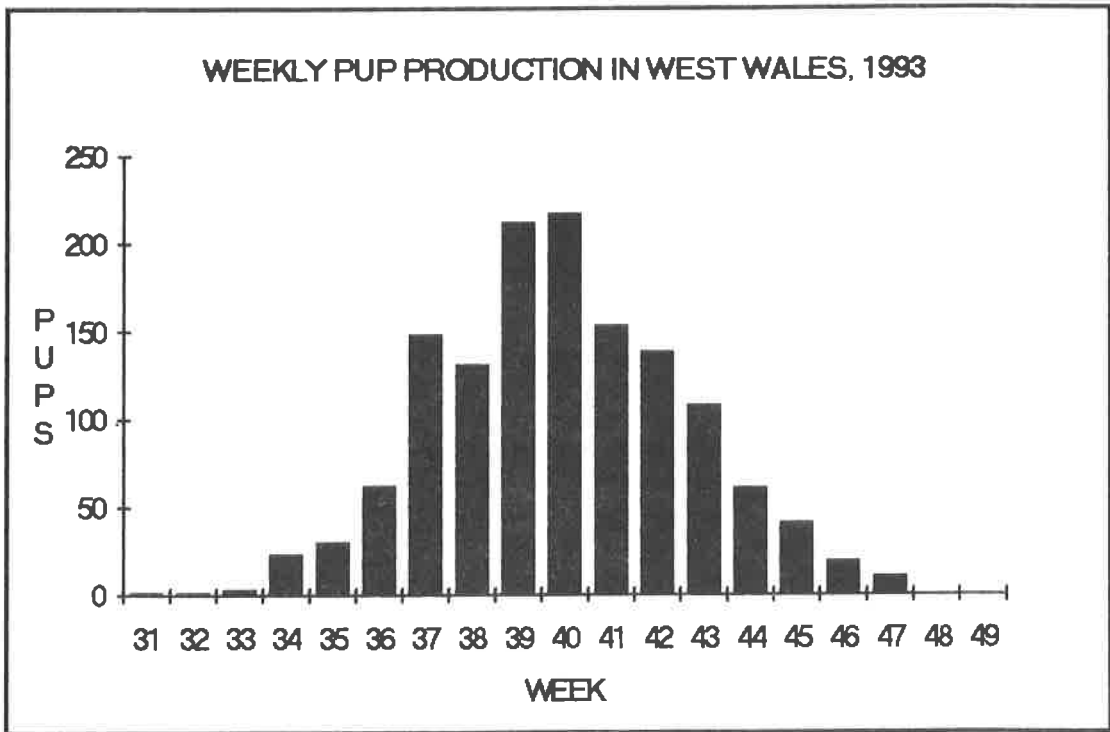

Fig. 1 Histogram of weekly grey seal pup production in West Wales, 1993

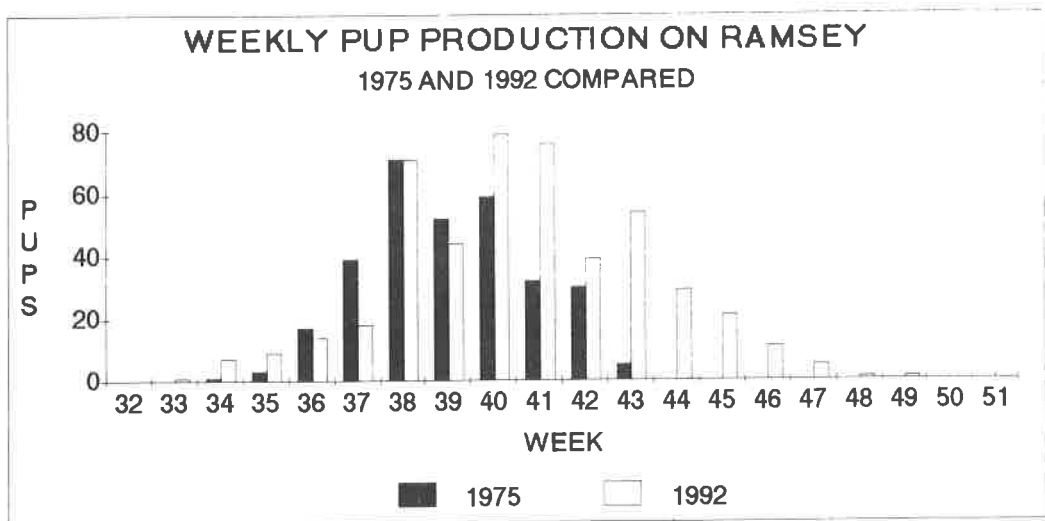

Fig. 2 Weekly pup production on Ramsey Island in 1975 and 1992

**PHOTO-IDENTIFICATION OF MEDITERRANEAN MONK SEALS
MONACHUS MONACHUS IN THE COAST OF THE SOUTHERN SAHARA**

Grau, E. *, Aguilar, A. *, González, J.** , San Félix M.***,
González, L. M.**** and López-Jurado, L. F. **

* Dept of Animal Biology, Faculty of Biology,
University of Barcelona, Barcelona, Spain

** Dept of Biology, University of Las Palmas, Las Palmas de Gran Canaria, Spain

***Lab. Mar. Biology, University of Valencia, Valencia, Spain

****National Inst. Nature Conservation (ICONA), Madrid, Spain

INTRODUCTION The Mediterranean monk seal (*Monachus monachus*) population inhabiting the southern Sahara coast is the only large cohesive aggregation of the species surviving today. The population has been estimated to comprise about one hundred individuals and its history is unknown. However, past population estimates based on visual counts of individuals in caves during short visits are unreliable. In 1992, we initiated a photo-identification survey in the area with three main objectives: (1) to determine minimum population size; (2) to ascertain geographic distribution and movement of individuals among caves and with neighbouring areas; and (3) to develop a non invasive technique to identify individuals for behavioural and biological studies. This paper presents preliminary results from this research.

FIELDWORK AND METHODS Photo-identification fieldwork was carried out in December 1992, March 1993, May - June 1993, and November - December 1993. Photographs of seals were taken from the top of the cliffs, situated above the entrance of caves or above the areas where individuals concentrate, in order to minimise disturbance to the colony. In this situation, the distance from the photographer to the seals usually ranged between 20 and 40 metres. Equipment used consisted of a Nikon F3 camera equipped with 500mm or 700mm (350mm with 2x converter) lenses loaded with Ektachrome film at 200 ASA film speed.

RESULTS The presence of scars, particularly those caused by interaction among individuals, was only obvious from the subadult stage. Pups and recently weaned juveniles rarely showed clear and permanent marks, or these apparently disappeared during the moult. Some seals with large and obvious marks were identifiable in the field, either with the naked eye or with binoculars. However, the identity of many individuals could only be confirmed upon detailed examination of tiny marks, which were only visible on the slides under a magnifying lens.

Most photographs were obtained from swimming seals and, in this situation, the regions of the body more often exposed to the photographer were the head, neck, and the dorsal area of the flanks. About 80% of identified scars were localised in these regions. The most common marks observed were light lines or thin stripes located on the dorsal region. In some cases, these scars were so abundant that they fused, forming an almost uniform white patch. Although few individuals could be sexed, the presence of these dorsal marks appeared to be more frequent in females than in males, which suggests that they are caused by injuries inflicted by males while mating, as observed in Hawaiian monk seals. These dorsal marks were less pigmented, and therefore more apparent, than similar marks observed in the Hawaiian seals. Given that the Sahara coast females live mostly in caves while those from Hawaii inhabit beaches, differences in exposure to daylight of the two species and in subsequent regeneration of melanin in the skin, may account for the observed difference (Gilmartin, *pers. comm.*).

Marks on the head and neck, usually consisting of small whitish dots or lines, were not so abundant but proved extremely useful for the identification of individuals.

In total, fifty seals have been identified to date: six juveniles, 33 subadults and adults, and 11 of unknown age-category. Re-sightings have been frequent and almost invariably occurred in the same cave where the seal had been observed for the first time. The maximum time elapsed between re-sightings was seven months and, in these cases, markings of the individuals concerned were not seen to change substantially. Only two seals, first identified in cave 1 in September 1993, were observed in cave 3 (situated at a distance of about 2.5 km) in December 1993. This suggests that seals show a strong site fidelity for the caves.

Besides increasing the database of identified individuals, present and future work focuses upon a continuous monitoring scheme for selected individuals to establish permanence of scars and variation through time. This will continue until at least a full year cycle has been covered, including a complete moult, in order to establish which marks persist or disappear during moulting.

ACKNOWLEDGEMENTS This project was sponsored by the European Nature Heritage Fund (EURONATURA), Consejería de Política Territorial del Gobierno Canario, the National Institute of Nature Conservation of Spain (ICONA), and BP Conservation Expedition. We thank Parc National du Banc d'Arguin and C.N.R.O.P. of Cansado by their helpful assistance. Mr. S. Brahim (AMAPHOM) co-operated in the research.

**PUPPING SEASON AND ANNUAL PRODUCTIVITY OF THE MONK SEAL
MONACHUS MONACHUS IN "CABO BLANCO" PENINSULA
(WESTERN SAHARA-MAURITANIA)**

Luis M. González *, Jos, R.González **, Manuel S. Felix *** , Esteve Grau ****,
Luis F. López-Jurado ** and Alex Aguilar ****

* Instituto Nacional para la Conservación de la Naturaleza (ICONA), 28005 Madrid , Spain

** Dpto. de Biología, Universidad de Las Palmas, Las Palmas de Gran Canaria, Spain

*** Lab. Biología Marina, Universidad de Valencia, Valencia, Spain

**** Dpto. de Biología Animal, Facultad de Biología,
Universidad de Barcelona, 08028 Barcelona, Spain

INTRODUCTION The information available on monk seal (*Monachus monachus*) breeding biology is scarce and fragmentary. For example, no data are available about annual productivity. The determination of the pupping season, which has been suggested to extend from May to December, was made by combining years, heterogeneous sources, and data originating from far distant, ecologically isolated, populations from the Mediterranean and the Atlantic.

We present here preliminary results from a survey carried out in the "Cabo Blanco" colony that produced, for the first time, precise data about the annual productivity of this colony. It is noteworthy that the pupping season in this colony appears to be protracted, apparently extending through the whole year.

METHODS During 1993 (March to December), we counted individuals present on the beaches and at the entrance of the two main breeding caves (1 and 3) of the colony (López-Jurado *et al.*, 1993). Counts were made at intervals of 2-3 months from the edge of the cliff situated above the beaches or the entrance of the caves (20-30 m away) in order to avoid disturbance to the seals. When sea conditions are good, the interior of the caves could be screened with binoculars, allowing precise counting. Individuals observed were assigned to an age-class following a similar categorisation as that used for *Monachus schauinslandii* by Stone (1984) and Johnson and Johnson (1984): pups, juveniles, subadults and adults.

Moreover, individuals estimated to be younger than half a year were subdivided into three age groups according to data from our own observations, from captive individuals (Hart & Vedder, 1990; SRRC, 1991) and from *M. schauinslandii* (Stone, 1984; Johnson and Johnson, 1984): nursing pups with lanugo; moulted pups (still nursing); and pups recently weaned (Table 1). This classification is subjective and, particularly that of already weaned pups, is not precisely delimited.

Date of birth of nursing pups, when not directly established by observation, was assumed to be in the same month that the first observation of the pup occurred. In the case of moulted and weaned pups, we took into consideration that: (a) the neonatal pelage of three captive *M. monachus* was moulted at the age of four to six weeks and lasted 25-45 days (Hart & Vedder, 1990; SRRC, 1991); (b) the average nursing period in *M. schauinslandii* lasts 38-40 days, and females end the lactation period abruptly, abandoning the pup (Johanos and Austin, 1988); and (c) the average interval between births in successive years is 379 days (range 361-408) (Johanos and Austin, 1988). Therefore, we assigned to nursing pups a maximum age of one month to those already moulted but nursing for less than one month, and, to weaned pups, a minimum of three months. Thus, for example, we considered that the weaned pups observed in March 1993 were moulted - nursing pups in January 1993, and nursing pups with lanugo in December, 1992.

RESULTS It is not possible to calculate the birth rate (adult females that give birth per year/number of adult females) because the total number of females in the population is unknown. However, we can estimate annual productivity. Thus, between March and December 1993, we identified 55 pups (33 nursing, 9 moulted and 13 weaned), from which 21 were in cave 1 and 34 in cave 3 (Table 2). This results in an annual productivity of 55 pups/year.

The monthly distribution of births of the 55 seals born in the study period (Table 3), indicate that the pupping season is protracted and extends almost throughout the whole year. Data do not show a clear seasonal peak in pupping, although the existence of a minor peak, given the limited amount of data so far available, cannot be ruled out.

ACKNOWLEDGEMENTS This project was sponsored by the European Nature Heritage Fund (EURONATURA), Consejería de Política Territorial del Gobierno Canario, the National Institute of Nature Conservation of Spain (ICONA), and BP Conservation Expedition. We thank Mr. S. Brahim (AMAPHOM), Parc National du Banc d'Arguin and C.N.R.O.P. of Cansado for their helpful assistance.

REFERENCES

- Hart, L. and Vedder L. 1990. The rehabilitation of two newborn Mediterranean monk seal (*Monachus monachus*) in the Seal Rehabilitation and Research Centre (SRRC) in Pieterburen, The Netherlands. Report SRRC, January 1990.
- Johanos, T. C. and Austin, S. L. 1988. Hawaiian monk seal population structure, reproduction and survival on Laysan Island, 1985. NOAA-TM-NMFS-SWFC-118
- Johnson, B. W. and Johnson, P. A. 1984. Observations of the hawaiian monk seal on Laysan island from 1977 through 1980. NOAA-TM- NMFS-SWFC-49.
- López-Jurado, L. F., González, L. M., González, J. R., Grau, E. San-Felix, M. and Aguilar, A. 1993. Le phoque moine (*Monachus monachus*) sur les côtes du Sahara occidental-Mauritanie: dernières données biologiques et mortalité, entre 1988-1993. Conseil de l'Europe T-PVS(93) 23: 24-40.
- Seal Rehabilitation and Research Centre. 1991. The rehabilitation of an orphaned Mediterranean monk seal (*Monachus monachus*) in the national Marine Park of the Northern Sporades, Greece. Report of the SRRC of Pieterburen. The Netherlands.
- Stone, H. S. 1984. Hawaiian monk seal population research, Lisianski Island, 1982. NOAA-TM-NMFS-SWFC-47.

AGE GROUP	PELAGE COLOUR	APPROX. SIZE	ASPECT	BEHAVIOUR
nursing (with lanugo)	black, white patch in the belly (neonatal)	80-110	wrinkle dull	rarely swimming , often suckling close to the mother
moulted nursing	silvery-grey dorsally , ligh ventrally, whithout scars	110-130	moulting or recently moulted, fat and rounded	regularly swimming, sometimes far from the mother rarely suckling, frequently playing
weaned	grey-brownish ligh ventrally, some scars	130-140	larger and slimmer than moulted-nursing pups	regularly swimming not related to the mother not suckling

Table 1 Classification of pups in age-groups according to their external characteristics and behaviour.

	CAVE 1			CAVE 3		
	WP	MNP	NP	WP	MNP	NP
March	6	3	3			
June	6	4	2	7	6	9
September	4	3	4	2	2	7
Nov	3	3	3	4	4	5

Table 2 number of nursing pups with lanugo (NP), moulted but still nursing pups (MNP) and weaned pups (WP) registered in caves 1 and 3.

	1992	1993										
	XII	I	II	III	IV	V	VI	VII	VIII	IX	X	XI
1	(6)	(3)		3			2			4		3
3				(7)	(6)		9			7		5
T	(6)	(3)		10	(6)		11			11		8

Table 3 Monthly distribution of births in caves 1 and 3, and estimated date of birth between brackets.

SEVENTH ANNUAL REPORT OF THE EUROPEAN CETACEAN SOCIETY: 1993

Paid-up membership of the European Cetacean Society at the start of the Montpellier Conference totalled 435 from 31 countries (24 European), with UK (151), Germany (89), Italy (46), the Netherlands (27), Spain (20), and Denmark (19) having the highest representation. Other member countries include Belgium, Croatia, Czech Republic, Faroe Islands, Finland, France, Greece, Iceland, Ireland, Monaco, Norway, Poland, Portugal, Romania, Russia, Slovenia, Sweden, Switzerland, Ukraine, and Argentina, Australia, Canada, Hong Kong, Japan, Peru, and USA.

A very successful conference was held in Inverness, Scotland between 18-21 February 1993, on the theme *Cetacean Social Organisation*, with an attendance of 275 persons from nineteen countries. Three invited speakers addressed the society: Andy Read and Randy Wells from North America, and Bill Amos from England. No workshop was organised at the 1993 conference. The conference was of a high scientific quality, and the entertainments were also much appreciated. The abstracts of that meeting were published as proceedings under the title *European Research on Cetaceans - 7*.

Three newsletters were produced during the year. Two of them reviewed recent research and news items in Europe and elsewhere in the world, conservation issues, cetacean meetings and publications, and Society business. We are very grateful to Marjan Addink and Joke Bakker for their dedication in helping with the editing of the newsletter. The third newsletter contained the proceedings of the first ECS workshop on "*Cetacean Pathology: Dissection techniques and Tissue Sampling*" held in Leiden, Netherlands, in September 1991. Thijs Kuiken and Manuel Garcia Hartmann are the editors of this special issue of the ECS newsletter.

The collaboration with the European Association for Aquatic Mammals (EAAM) continued in 1993. As agreed between the two Societies, the 1994 EAAM annual conference was announced in the ECS newsletter. The EAAM did not reciprocate, but apologies were received from the EAAM Secretary for this omission. Delegates were exchanged at the annual conferences.

A closer collaboration was initiated between the boards of the Society for Marine Mammalogy (SMM) and the ECS, in particular with a view to organising a joint meeting in Europe in 1998. At the SMM biennial conference in November in Texas, the chairman of the ECS was given the opportunity to present the society to the SMM membership during the AGM.

Finally, the European Cetacean Society has continued to provide advice to government departments and non-governmental organisations in European countries, and specialist information for various public enquiries. Official contact was made with the ASCOBANS Secretariat, and the ECS requested an official observer position. This should be decided at the next ASCOBANS meeting in Sweden in September 1994.

GENEVIEVE DESPORTES
(SECRETARY)

**FINANCIAL REPORT FOR THE YEAR
UP TO 28 FEB 1994**

CREDIT

Balance as of 16 Feb 93	£6,779.57
<u>Credit</u>	£
Membership & donations	4,732.40
Conference income	1,177.75
Sale of Proceedings	280.00
Interest	84.78
	<hr/>
Total Income	£6,274.93
	<hr/>

<u>Debit</u>	£
Secretarial expenses at SMRU	687.50
Council members' expenses	1,474.82
Publications (Proceedings & Newsletters)	5,233.07
Postage, envelopes, etc	1,703.56
Conference costs	457.70
E-mail box rental	120.35
	<hr/>
Total Expenditure	£9,677.00
	<hr/>

Balance as of 28 February 1994 £3,377.50

PHILIP HAMMOND
(TREASURER)

EUROPEAN CETACEAN SOCIETY

The **European Cetacean Society** was formed in January 1987 at a meeting of eighty cetologists from ten European countries. A need was felt for a society that brought together people from European countries studying cetaceans in the wild, allowing collaborative projects with international funding.

AIMS (1) to promote and co-ordinate the scientific study and conservation of cetaceans;
(2) to gather and disseminate information to members of the society and the general public.

ACTIVITIES The Society set up seven international working groups concerned with the following subject areas: sightings schemes; strandings schemes; cetacean pathology; bycatches of cetaceans in fishing gear; computer data bases that are compatible between countries; the harbour porpoise (a species in apparent decline in Europe, and at present causing serious concern); and a regional agreement for the protection of small cetaceans in Europe (in co-operation with the United Nations Environment Program/Convention on the Conservation of Migratory Species of Wild Animals, Secretariat in Bonn, Germany). Recently, some of these have been disbanded, having served their purpose, and two new groups (covering the North & Baltic Seas and the Mediterranean Sea respectively) have been set up. The names and addresses of contact persons for all working groups are given at the end.

Contact persons have been set up in each European member country, where appropriate, to facilitate the dissemination of ECS material to members, if necessary carrying out translations into the language of that country. Their names and addresses are also given below.

A newsletter is produced three times a year for members, reporting current research in Europe, recent publications and abstracts, reports of working groups, conservation issues, legislation and regional agreements, local news, and cetacean news from other parts of the world.

There is an annual conference with talks and posters, and at which the annual general meeting is held. The results are published as annual proceedings, under the title *European Research on Cetaceans*. Besides the present volume, seven others have been published for conferences held in Hirtshals (Denmark) in 1987, Tróia (Portugal) in 1988, La Rochelle (France) in 1989, Palma de Mallorca (Spain) in 1990, Sandefjord (Norway) in 1991; San Remo (Italy) in 1992, and Inverness (Scotland) in 1993. At intervals, workshops are also held on particular topics, and the results published as special issues of the newsletter: no. 6 - a workshop on the harbour porpoise, held in Cambridge (England) in 1988; no. 10 - a sightings workshop held in Palma de Mallorca (Spain) in 1990; and no. 17 - a workshop to standardise techniques used in pathology of cetaceans held in Leiden (Netherlands) in 1991.

Membership is open to *anyone* with an interest in cetaceans. The annual subscription is **£25** for full and institutional members, or **£15** for those who are 25 years of age or younger, full-time students or unwaged. Payment may be made at the Annual Conference in pounds sterling or the currency of the host country. During the year, payment may be made by cheque drawn on a UK bank, or Eurocheque or by direct transfer in pounds sterling in the name of the *European Cetacean Society* into bank account no. 7801067 (bank sort code 30-91-56) of Lloyds Bank, 3 Sidney Street, Cambridge CB2 3HQ, UK. Payment in excess of the membership fee will be gratefully received as a donation to the Society. Please send subscriptions to the Treasurer, **Dr. P. Hammond, SMRU, c/o British Antarctic Survey, High Cross, Madingley Road, Cambridge CB3 0ET, UK.**

OFFICERS AND MEMBERS OF COUNCIL

Chairman: Giuseppe Notarbartolo di Sciara
Secretary: Finn Larsen
Treasurer: Phil Hammond
Editor: Peter Evans
Members: Mads-Peter Heide-Jørgensen
Marina Loewenstein de Sequeira
Toni Raga
Ursula Siebert

WORKING GROUP CONTACT PERSONS

Computer Support Group: Jan Willem Broekema, Brikkewal 20, 2317 CT Leiden, The Netherlands

Pathology: Manuel Garcia Hartmann, Duisburg Zoo, Mülheimerstrasse 273, 47058 Duisburg, Germany.

Sightings: Peter Evans (see UK below)

North & Baltic Seas: Carl Kinze (see Denmark below)

Mediterranean Sea: Alex Aguilar (see Spain below)

NATIONAL CONTACT PERSONS

Belgium Claude Joiris, Vrije Universiteit Brussel, Laboratorium voor Ecotoxicologie, Pleinlaan 2, B-1050 Brussels (Tel. +32 2 641 3414; fax +32 2 641 3419)

Denmark Carl Kinze, Zoologisk Museum, Universitetsparken 15, DK-2100 København Ø (Tel. +45 35 321000; fax +45 35 321010)

Faroe Islands Dorete Bloch, Museum of Natural History, Fútalág 40, FR-100 Tórshavn (Tel. +298 1 8588; fax +298 1 8589)

France Alexandre Gannier, 14 Rue des Capucines, F-33170 Gradignan (Tel. +33 56 890220 or +33 93 658936)

Germany Harald Benke, Forschungs- und Technologiezentrum, Universität Kiel, Werfistrasse 10, D-25761 Busum (Tel. +49 48 34 604280; fax +49 48 34 6772)

Iceland Jóhann Sigurjónsson, Marine Research Institute, Skúlagata 4, P.O. Box 1390, IS-121 Reykjavík (Tel. +354 1 20240; fax +354 1 62370)

Ireland Simon Berrow, Department of Zoology, University College Cork, Lee Maltings, Prospect Row, Cork (Tel. +353 21 276871; fax +353 21 274034)

Italy Giuseppe Notarbartolo di Sciara, Istituto Tethys, Via Giusti 5, I-20154 Milano (Tel. +39 2 314403; fax +39 2 29401987)

The Netherlands Chris Smeenk, National Museum of Natural History, PO Box 9517, NL-2300 RA Leiden (Tel. +31 71 143844; fax +31 71 133344)

Norway Arne Björge, Norsk Institut for Naturforskning - NINA, University of Oslo, PO Box 1037, Blindern, N-0315 Oslo 3 (Tel. +47 2 854515; fax +47 2 856016)

Portugal Marina Loewenstein de Sequeira, Serviço Nacional de Parques, Reservas e Conservação da Natureza, Rua Filipe Folque 46-3º, P-1000 Lisboa (Tel. +351 1 3523018; fax +351 1 574771)

Russia M.V. Ivashin, All-Union Research Institute of Marine Fisheries & Oceanography (VNIRO), 17 V. Krasnoselskaya, Moscow, B-140, 107140.

Spain Alex Aguilar, Dept. de Biología Animal (Vertebrats), Facultad de Biología, Universitat de Barcelona, Diagonal 645, E-08071 Barcelona (Tel. +34 3 4021453; fax +34 3 411 0887)

Sweden Per Berggren, Zoölogical Instituut, University of Stockholm, 10691 Stockholm

Switzerland Beatrice Jann, Museo di Storia Naturale, Via Cattaneo 4, CH-6900 Lugano (Tel. +41 91 560953; fax +41 91 239020)

United Kingdom Peter Evans, Dept of Zoology, South Parks Road, GB-Oxford OX1 3PS (Tel./Fax +44 865 727984)